

# SKT 300

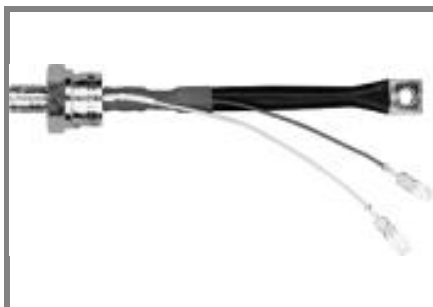

**Stud Thyristor**

## Line Thyristor

### SKT 300

#### Features

- Hermetic metal case with glass insulator
- Threaded stud ISO M24x1,5 or UNF 3/4-16
- High  $i^2t$  and  $I_{TSM}$  values for easy fusing
- International standard case

#### Typical Applications

- DC motor control (e. g. for machine tools)
- Controlled rectifiers (e. g. for battery charging)
- AC controllers (e. g. for temperature control)
- Recommended snubber network e. g. for  $V_{VRMS} \leq 400$  V:  
 $R = 33 \Omega / 32$  W,  $C = 0,47 \mu F$

1) available with UNF thread 3/4-16 UNF2A, e. g. SKT 300/08D UNF

$V_{RSM}$ V	$V_{RRM}, V_{DRM}$ V	$I_{TRMS} = 550$ A (maximum value for continuous operation) $I_{TAV} = 300$ A (sin. 180; $T_c = 93$ °C)	
500	400	SKT 300/04D	
900	800	SKT 300/08D <sup>1)</sup>	
1300	1200	SKT 300/12E <sup>1)</sup>	
1500	1400	SKT 300/14E <sup>1)</sup>	
1700	1600	SKT 300/16E <sup>1)</sup>	

Symbol	Conditions	Values	Units
$I_{TAV}$	sin. 180; $T_c = 100$ (85) °C	257 (351)	A
$I_D$	K0,55; $T_a = 45$ °C; B2 / B6	250 / 360	A
	K0,55F; $T_a = 35$ °C; B2 / B5	570 / 800	A
$I_{RMS}$	K0,55; $T_a = 45$ °C; W1C	280	A
$I_{TSM}$	$T_{vj} = 25$ °C; 10 ms	11000	A
	$T_{vj} = 130$ °C; 10 ms	10000	A
$i^2t$	$T_{vj} = 25$ °C; 8,35 ... 10 ms	600000	A <sup>2</sup> s
	$T_{vj} = 130$ °C; 8,35 ... 10 ms	500000	A <sup>2</sup> s
$V_T$	$T_{vj} = 25$ °C; $I_T = 800$ A	max. 1,45	V
$V_{T(TO)}$	$T_{vj} = 130$ °C	0,9	V
$r_T$	$T_{vj} = 130$ °C	0,5	mΩ
$I_{DD}; I_{RD}$	$T_{vj} = 130$ °C; $V_{RD} = V_{RRM}; V_{DD} = V_{DRM}$	max. 50	mA
$t_{gd}$	$T_{vj} = 25$ °C; $I_G = 1$ A; $di_G/dt = 1$ A/μs	1	μs
$t_{gr}$	$V_D = 0,67 * V_{DRM}$	2	μs
$(di/dt)_{cr}$	$T_{vj} = 130$ °C	max. 100	A/μs
$(dv/dt)_{cr}$	$T_{vj} = 130$ °C; SKT ...D / SKT ...E	max. 500 / 1000	V/μs
$t_q$	$T_{vj} = 130$ °C	50 ... 150	μs
$I_H$	$T_{vj} = 25$ °C; typ. / max.	150 / 250	mA
$I_L$	$T_{vj} = 25$ °C $R_G = 33 \Omega$ ; typ. / max.	300 / 600	mA
$V_{GT}$	$T_{vj} = 25$ °C; d.c.	min. 3	V
$I_{GT}$	$T_{vj} = 25$ °C; d.c.	min. 200	mA
$V_{GD}$	$T_{vj} = 130$ °C; d.c.	max. 0,25	V
$I_{GD}$	$T_{vj} = 130$ °C; d.c.	max. 10	mA
$R_{th(j-c)}$	cont.	0,09	K/W
$R_{th(j-c)}$	sin. 180	0,096	K/W
$R_{th(j-c)}$	rec. 120	0,101	K/W
$R_{th(c-s)}$		0,015	K/W
$T_{vj}$		- 40 ... + 130	°C
$T_{stg}$		- 55 ... + 150	°C
$V_{isol}$		-	V~
$M_s$	to heatsink	60 (UNF: 30)	Nm
$a$		5 * 9,81	m/s <sup>2</sup>
$m$	approx.	450	g
Case		B 7	



**SKT**

# SKT 300

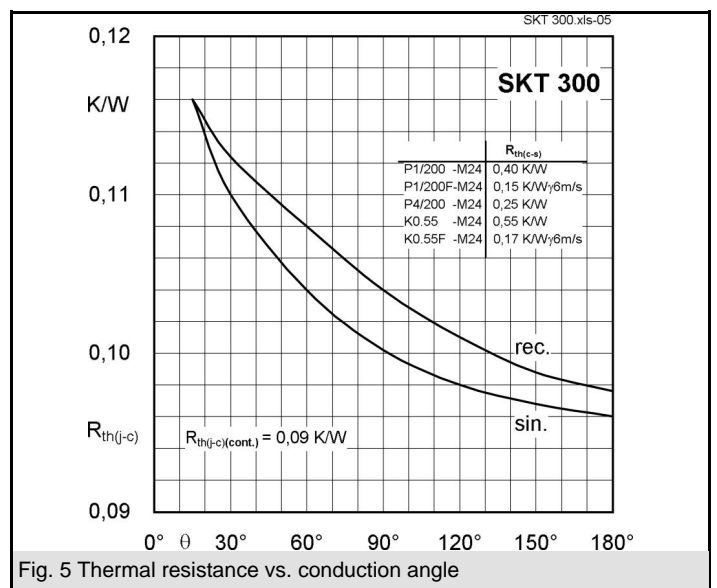
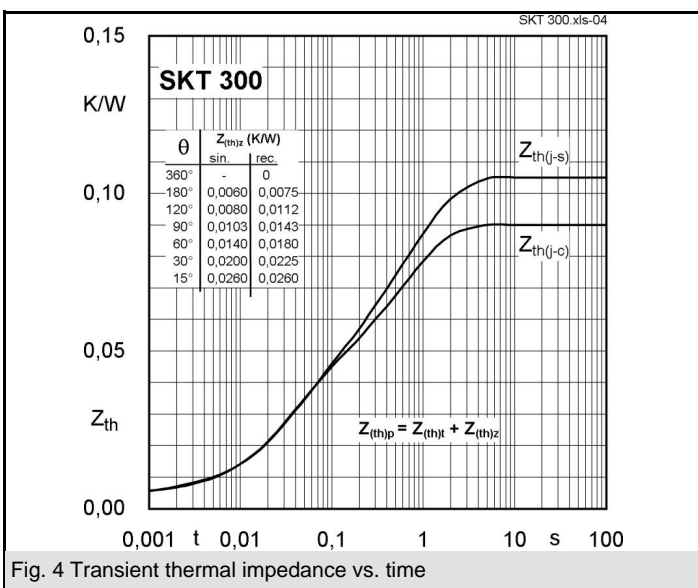
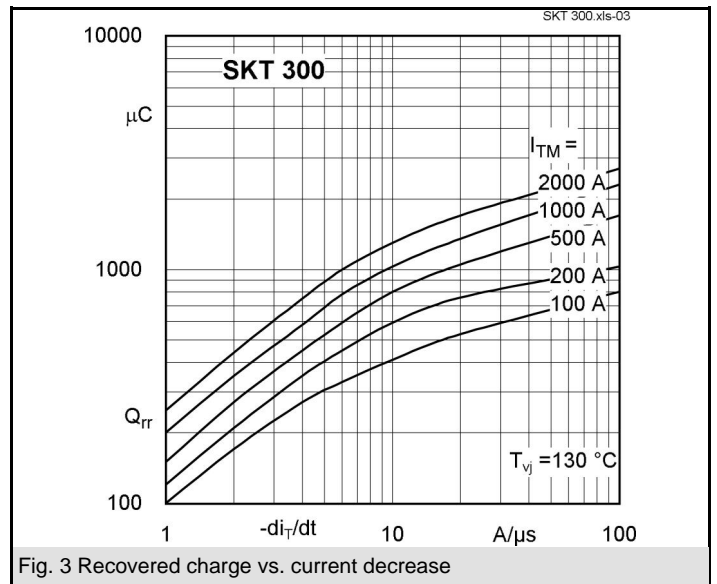
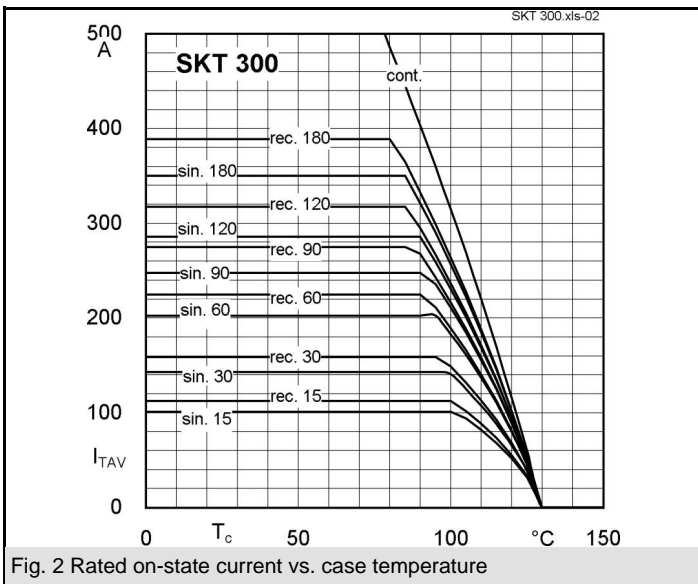
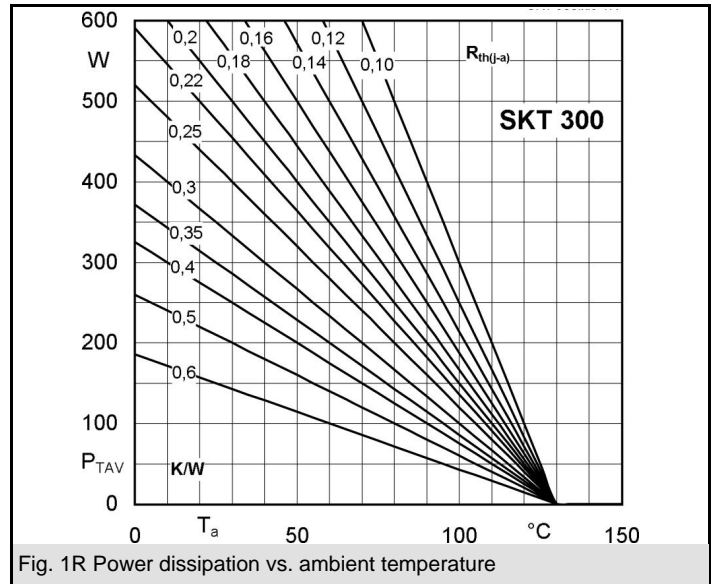
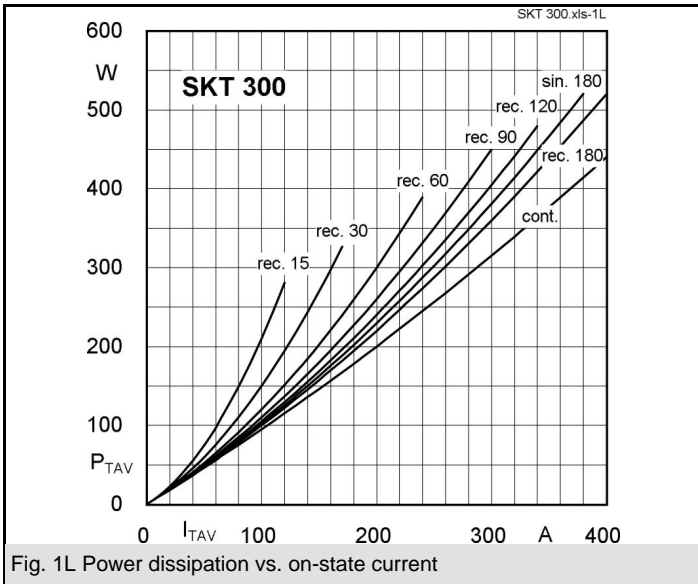

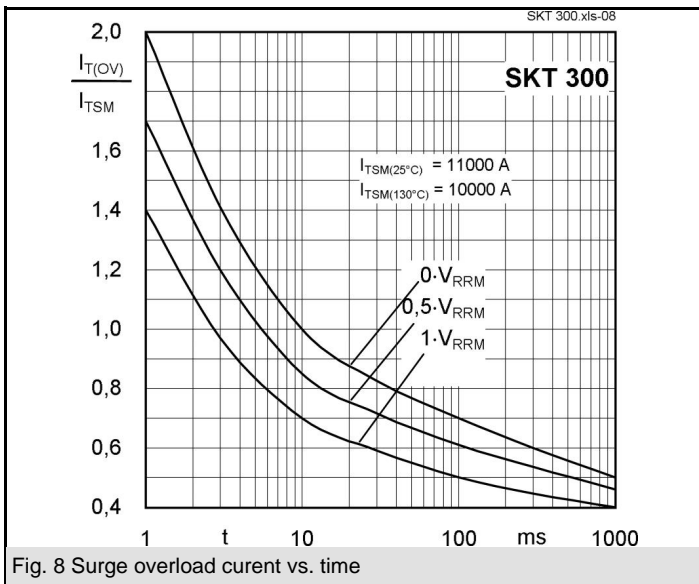
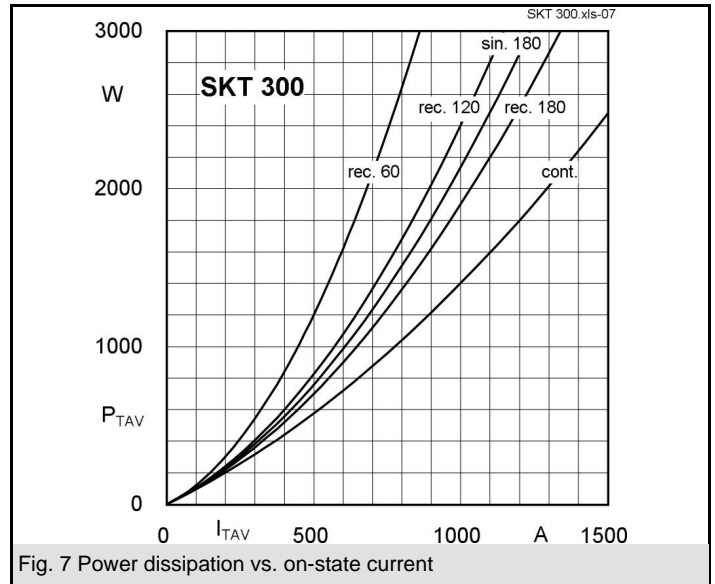
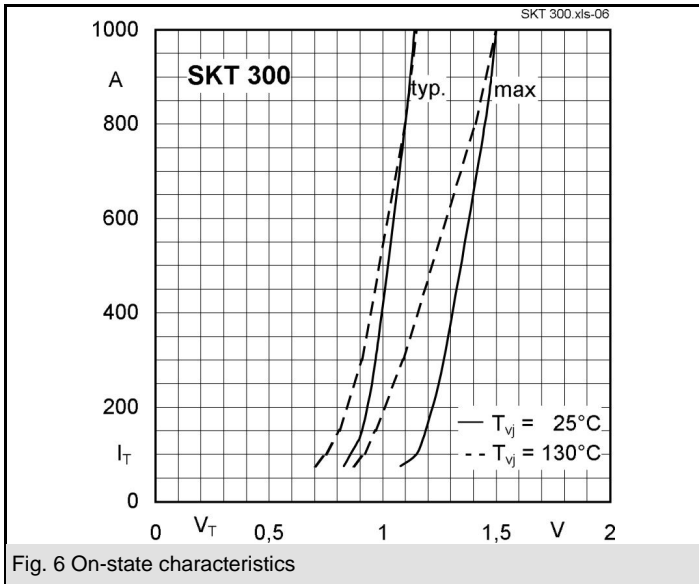

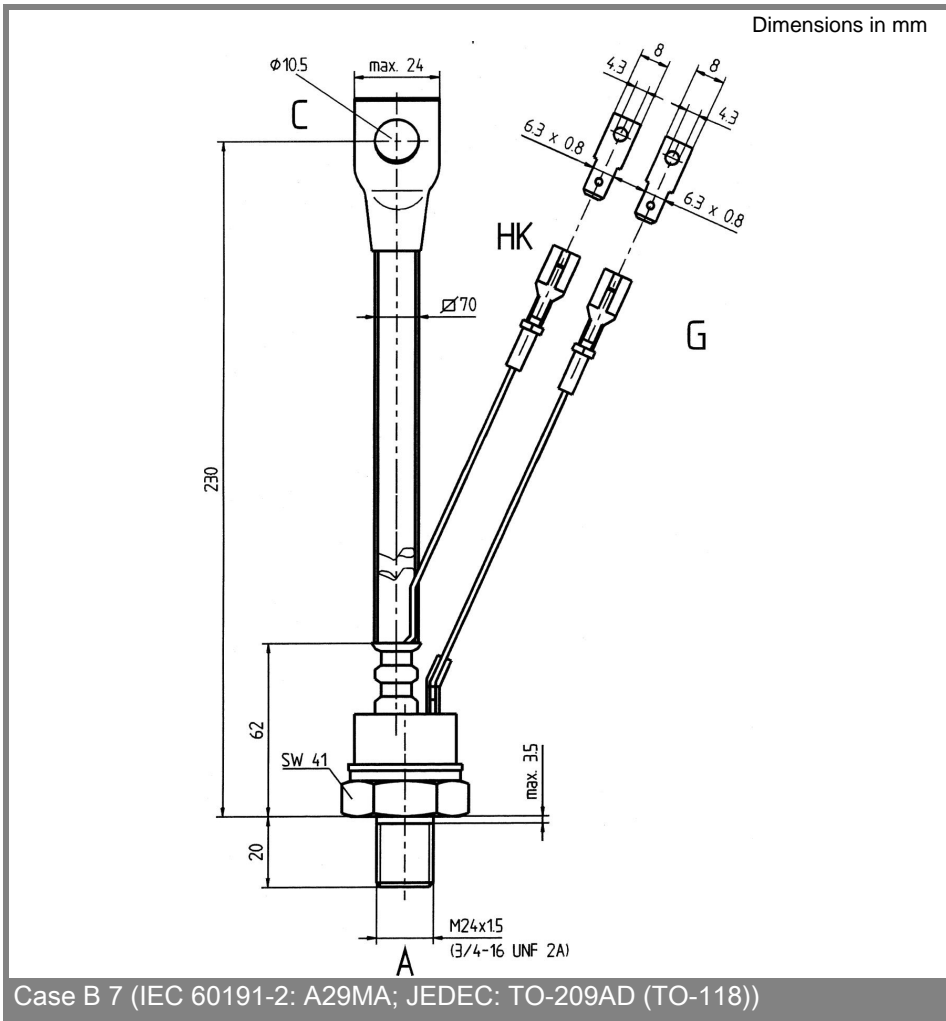
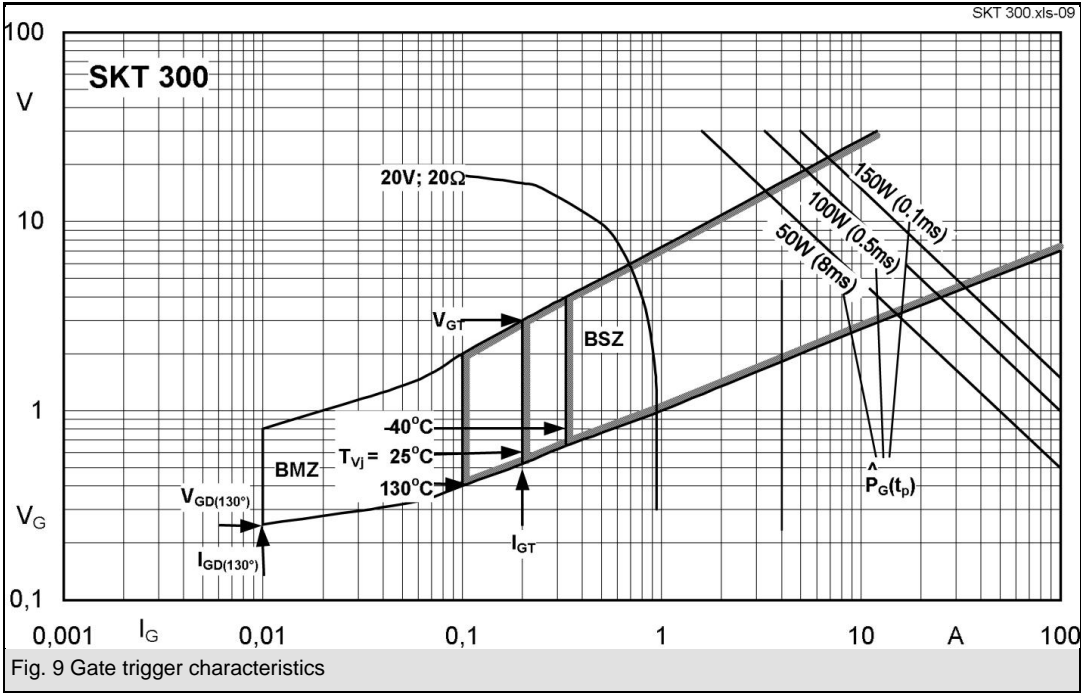

This technical information specifies semiconductor devices but promises no characteristics. No warranty or guarantee expressed or implied is made regarding delivery, performance or suitability.