

Thyristors

SKT 1800 SKT 2400



Features

- Hermetic metal cases with ceramic insulators
- Amplifying gates
- Capsule packages for double sided cooling
- Shallow design with single sided cooling
- Off-state and reverse voltages up to 1800 V

Typical Applications

- DC motor control (e. g. for machine tools)
- Controlled rectifiers (e. g. for battery charging)
- AC controllers (e. g. for temperature control)
- Soft starters for AC motors

V _{RSM}	V _{RRM} V _{DRM}	$\left(\frac{dv}{dt}\right)_{cr}$	I _{T(RMS)} (maximum values for continuous operation)	
			4500 A	5700 A
V	V	V/μs	I _{TAV} (sin. 180; T _{case} = . . . ; DSC)	
			2500 A (60 °C)	3000 A (56 °C)
1300	1200	1000	SKT 1800/12 E	SKT 2400/12 E
1500	1400	1000	SKT 1800/14 E	SKT 2400/14 E
1700	1600	1000	SKT 1800/16 E	SKT 2400/16 E
1900	1800	1000	-	SKT 2400/18 E

Symbol	Conditions	SKT 1800	SKT 2400
I _{TAV}	sin. 180; (T _{case} = ...); DSC	1800 A (85 °C)	2400 A (75 °C)
I _{TSM}	T _{vj} = 25 °C T _{vj} = 125 °C	53 000 A 45 000 A	55 000 A 47 000 A
i ² _t	T _{vj} = 25 °C T _{vj} = 125 °C	14 000 000 A ² s 10 000 000 A ² s	15 125 000 A ² s 11 000 000 A ² s
t _{gd}	T _{vj} = 25 °C; I _G = 1 A; di _G /dt = 1 A/μs	typ. 1 μs	
t _{gr}	V _D = 0,67 · V _{DRM}	typ. 2 μs	
(di/dt) _{cr}	f = 50 . . . 60 Hz	150 A/μs	
I _H	T _{vj} = 25 °C; typ./max.	500 mA/1 A	
I _L	T _{vj} = 25 °C; typ./max.	2 A/5 A	
t _q	T _{vj} = 125 °C; typ.	200 ... 300 μs	
V _T	T _{vj} = 25 °C; I _T = 3000 A; max.	1,25 V	1,37 V
V _{T(TO)}	T _{vj} = 125 °C	0,88 V	0,88 V
r _T	T _{vj} = 125 °C	0,124 mΩ	0,164 mΩ
I _{DD} , I _{RD}	T _{vj} = 125 °C; V _{DD} = V _{DRM} ; V _{RD} = V _{RRM}	100 mA	100 mA
V _{GT}	T _{vj} = 25 °C	3 V	
I _{GT}	T _{vj} = 25 °C	300 mA	
V _{GD}	T _{vj} = 125 °C	0,25 V	
I _{GD}	T _{vj} = 125 °C	10 mA	
R _{thjc}	cont. DSC	0,015	0,0105
R _{thch}	sin. 180; DSC/SSC } °C/W rec. 120; DSC/SSC	0,0155/0,0330	0,0110/0,0240
		0,0165/0,0345	0,0118/0,0250
T _{vj}	DCS/SSC	0,003/0,006	0,002/0,004
T _{stg}		- 40 ... +125 °C - 40 ... +130 °C	
F	SI units	27 ... 34 kN	37 ... 47 kN
w	US units	6000 ... 7600 lbs.	8000 ... 10000 lbs
		1 kg	1,7 kg
Case		B 19	B 20

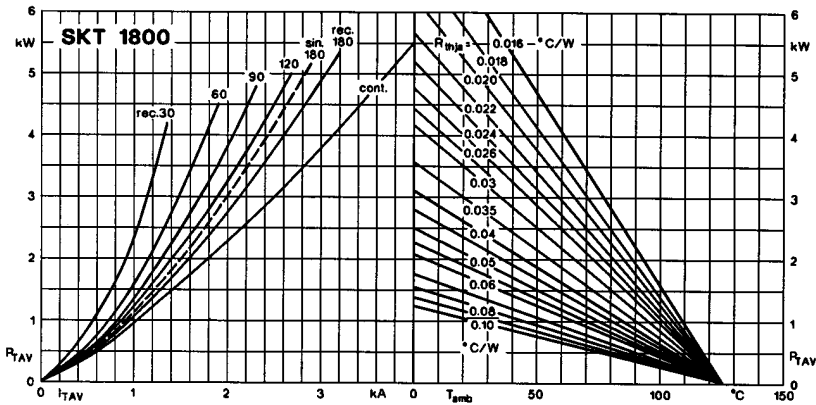

Fig. 1 a Power dissipation vs. on-state current and ambient temperature

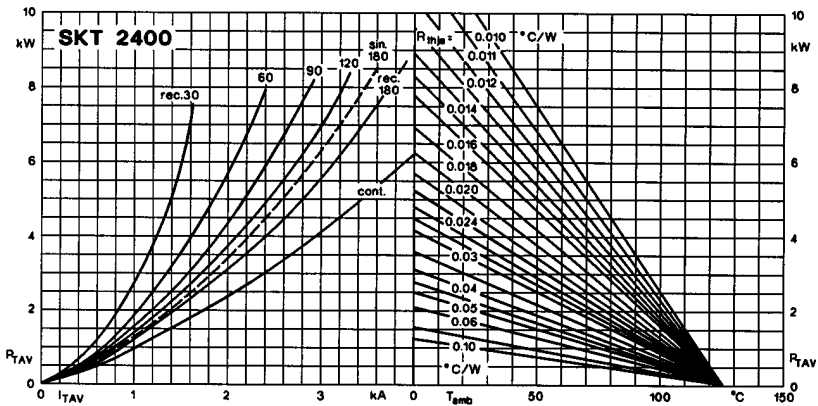

Fig. 1 b Power dissipation vs. on-state current and ambient temperature

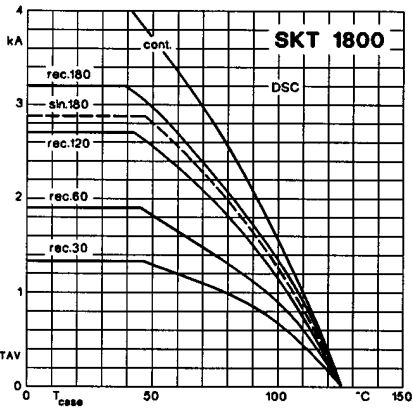

Fig. 2 a Rated on-state current vs. case temperature

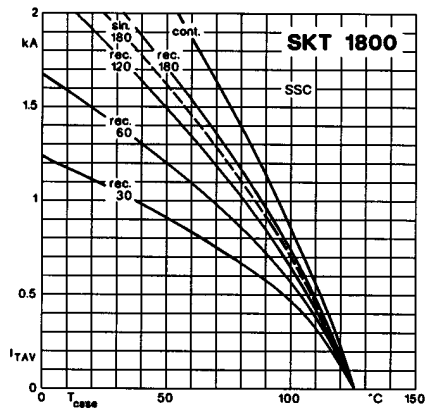

Fig. 2 b Rated on-state current vs. case temperature

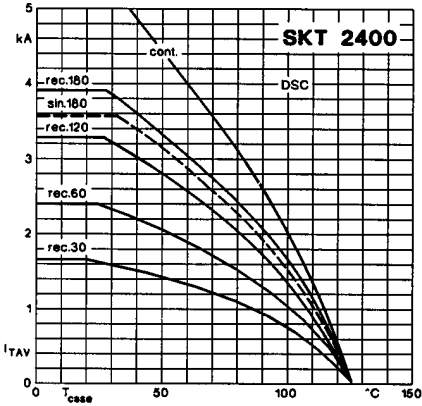

Fig. 2 c Rated on-state current vs. case temperature

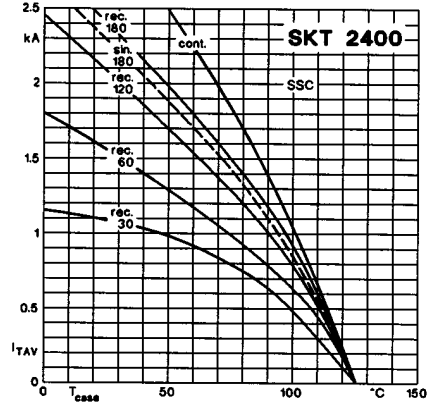

Fig. 2 d Rated on-state current vs. case temperature

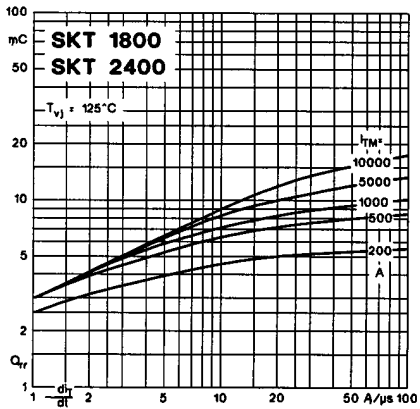

Fig. 3 Recovered charge vs. current decrease

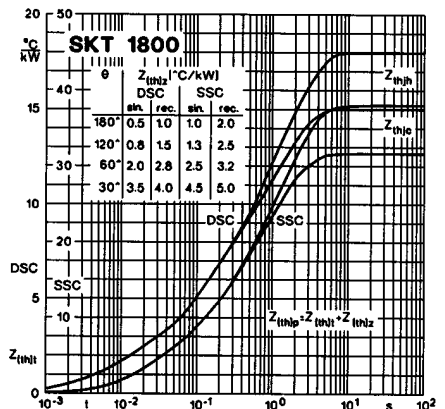

Fig. 4 a Transient thermal impedance vs. time

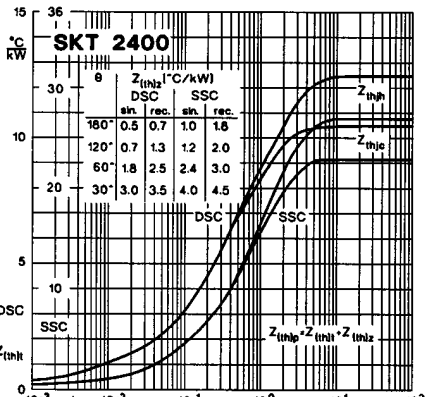

Fig. 4 b Transient thermal impedance vs. time

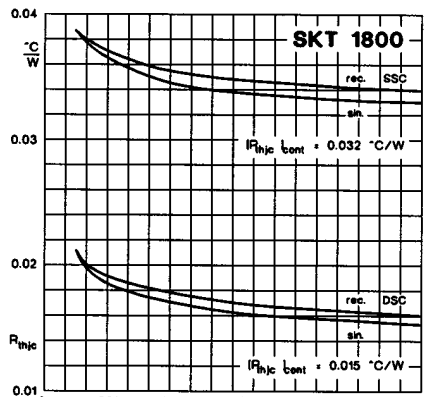

Fig. 5 a Thermal resistance vs. conduction angle

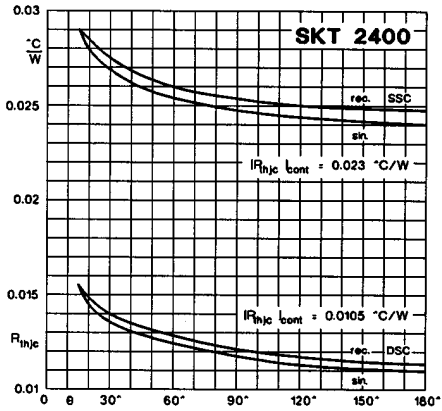

Fig. 5 b Thermal resistance vs. conduction angle

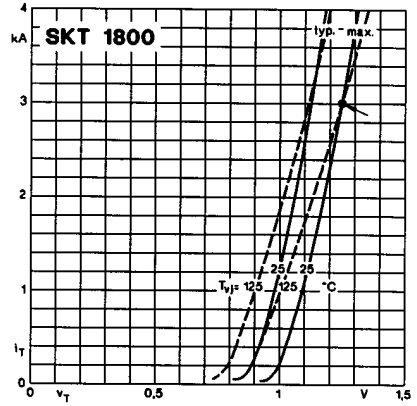

Fig. 6 a On-state characteristics

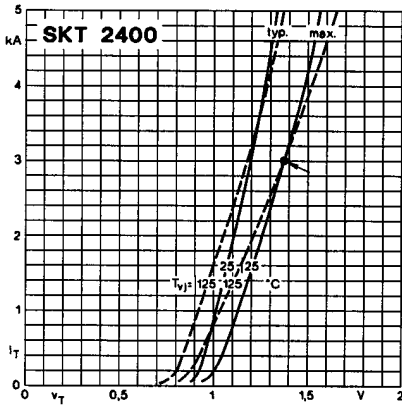

Fig. 6 b On-state characteristics

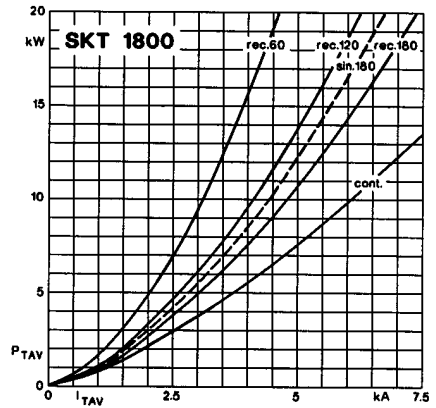

Fig. 7 a Power dissipation vs. on-state current

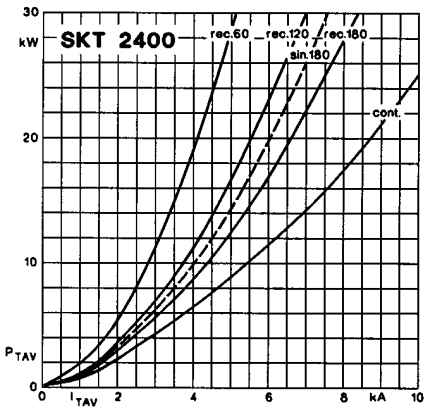

Fig. 7 b Power dissipation vs. on-state current

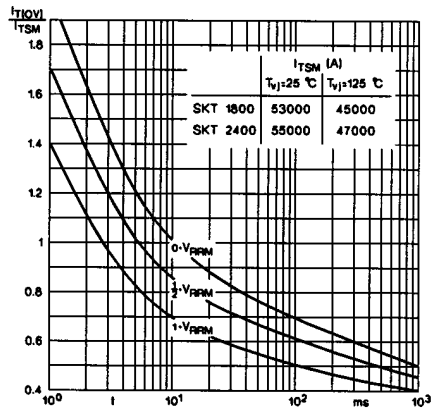

Fig. 8 Surge overload current vs. time

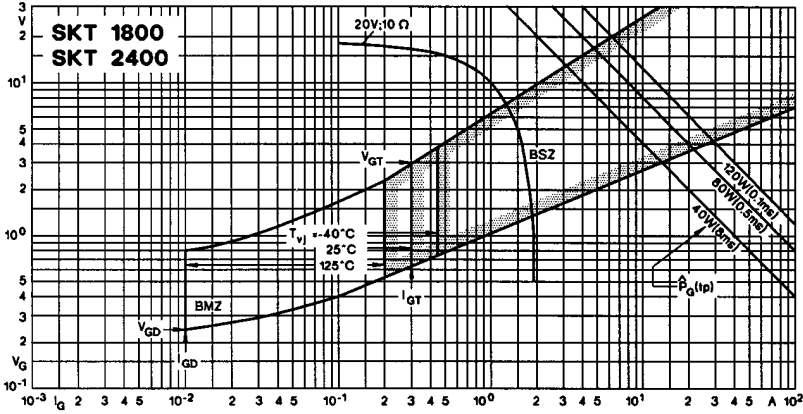
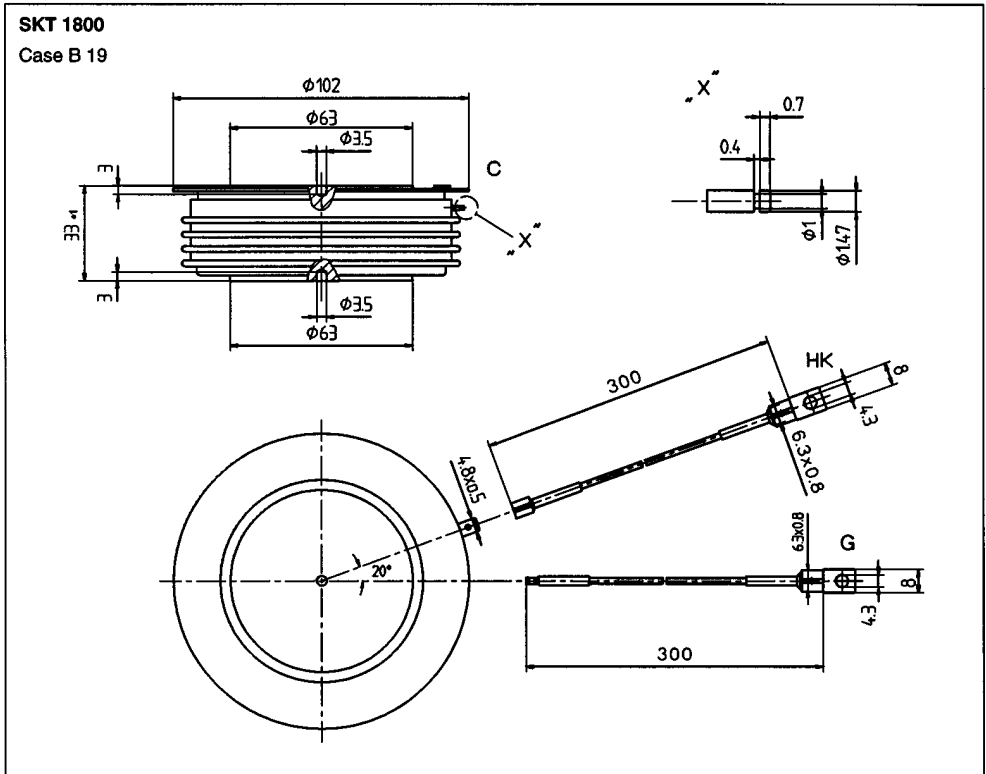

Fig. 9 Gate trigger characteristics



- C: Cathode terminal
- A: Anode terminal
- G: Gate terminal (yellow sleeve)
- HK: Auxiliary cathode terminal (red sleeve)

Dimensions in mm

SKT 2400

Case B 20

JEDEC: TO-200 AF

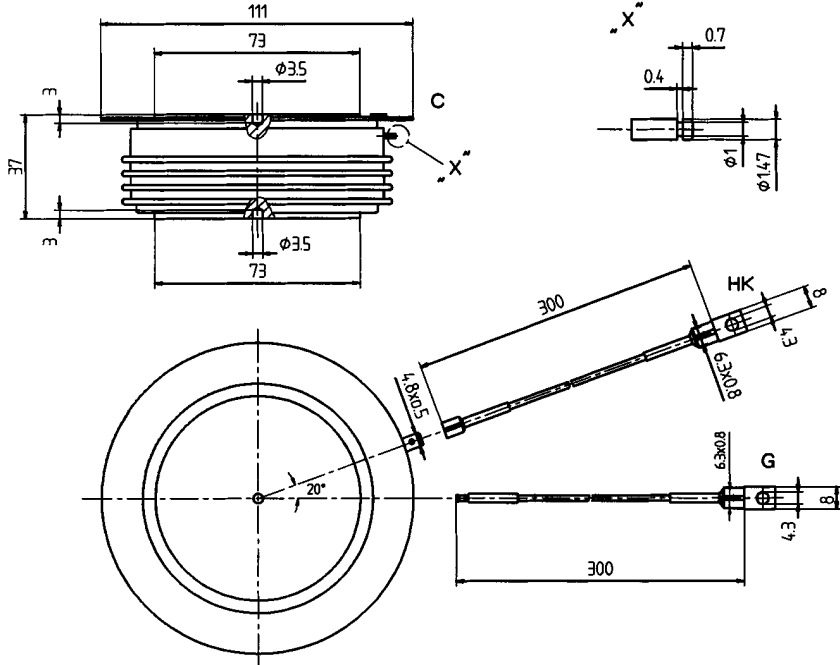

- C: Cathode terminal
- A: Anode terminal
- G: Gate terminal (yellow sleeve)
- HK: Auxiliary cathode terminal (red sleeve)

Dimensions in mm