

Thyristors

**SKT 130
SKT 160**

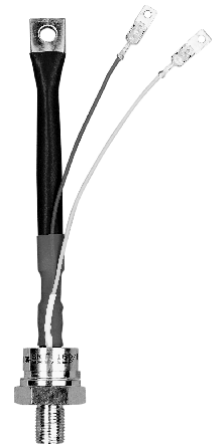

Features

- Hermetic metal cases with ceramic insulators
- Threaded studs ISO M16 x 1,5 or UNF 3/4-16
- International standard cases

Typical Applications

- DC motor control (e. g. for machine tools)
- Controlled rectifiers (e. g. for battery charging)
- AC controllers (e. g. for temperature control)

V _{RSM}	V _{RRM} V _{DRM}	$\left(\frac{dv}{dt}\right)_{cr}$	I _{TRMS} (maximum values for continuous operation)	
			220 A	280 A
V	V	V/μs	I _{TAV} (sin. 180; T _{case} = . . . °C)	
			140 A (80 °C)	178 A (78 °C)
500	400	500	SKT 130/04 D	SKT 160/04 D
700	600	500	SKT 130/06 D	SKT 160/06 D
900	800	500	SKT 130/08 D	SKT 160/08 D
1300	1200	1000	SKT 130/12 E	SKT 160/12 E*
1500	1400	1000	SKT 130/14 E	SKT 160/14 E
1700	1600	1000	SKT 130/16 E	SKT 160/16 E*

Symbol	Conditions	SKT 130	SKT 160	Units
I _{TAV}	sin. 180; T _{case} = 85 °C	130	160	A
I _{TSM}	T _{vj} = 25 °C; 10 ms T _{vj} = 130 °C; 10 ms	3500 3000	4300 3750	A A
i ² t	T _{vj} = 25 °C; 8,35 ... 10 ms T _{vj} = 130 °C; 8,35 ... 10 ms	61 000 45 000	92 500 70 000	A ² s A ² s
t _{gd}	T _{vj} = 25 °C; I _G = 1 A; di _G /dt = 1 A/μs	typ. 1		μs
t _{gr}	V _D = 0,67 · V _{DRM}	typ. 2		μs
(di/dt) _{cr}	f = 50 . . . 60 Hz	100		A/μs
I _H	T _{vj} = 25 °C	typ. 150; max. 250		mA
I _L	T _{vj} = 25 °C; R _G = 33 Ω	typ. 300; max. 600		mA
t _q	T _{vj} = 130 °C; typ.	120		μs
V _T	T _{vj} = 25 °C; I _T = 500 A; max.	2,25	1,75	V
V _{T(TO)}	T _{vj} = 130 °C	1,20	1,0	V
r _T	T _{vj} = 130 °C	2,2	1,5	mΩ
I _{DD} , I _{RD}	T _{vj} = 130 °C; V = V _{DRM} ; V _{RRM}	50	50	mA
V _{GT}	T _{vj} = 25 °C	3		V
I _{GT}	T _{vj} = 25 °C	200		mA
V _{GD}	T _{vj} = 130 °C	0,25		V
I _{GD}	T _{vj} = 130 °C	10		mA
R _{thjc}	cont.	0,16		°C/W
	sin. 180/rec. 120	0,18/0,20		°C/W
R _{thch}		0,03		°C/W
T _{vj}		- 40 ... +130		°C
T _{stg}		- 55 ... +150		°C
M	SI units	30		Nm
	US units	265		lb. in.
a		5 · 9,81		m/s ²
w		210		g
Case		B 6		

* Available with UNF thread 3/4-16 UNF2A; e.g. SKT 160/12 E UNF

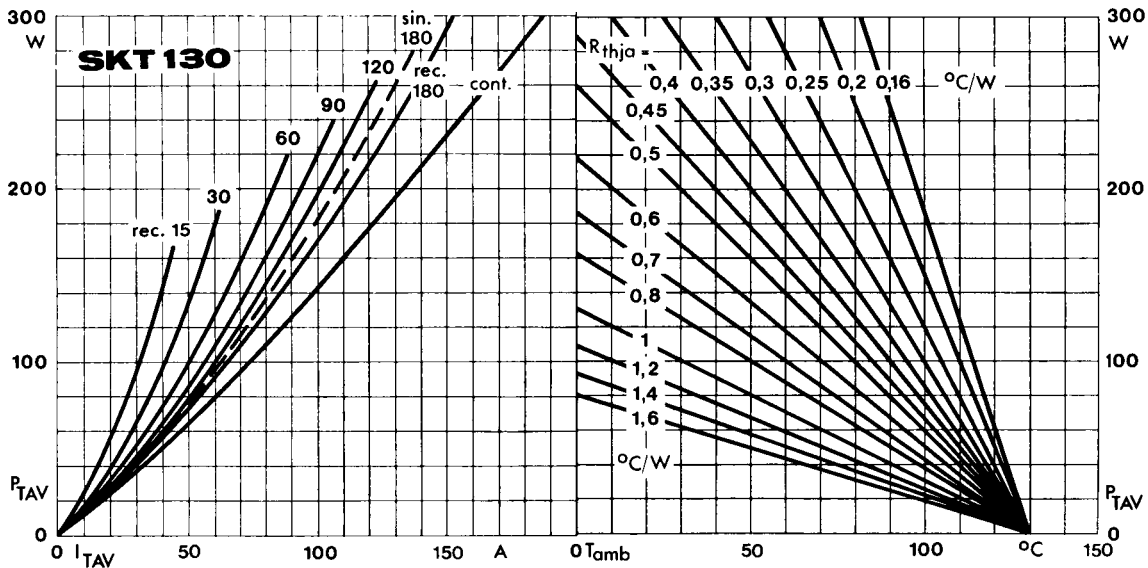

Fig. 1 a Power dissipation vs. on-state current and ambient temperature

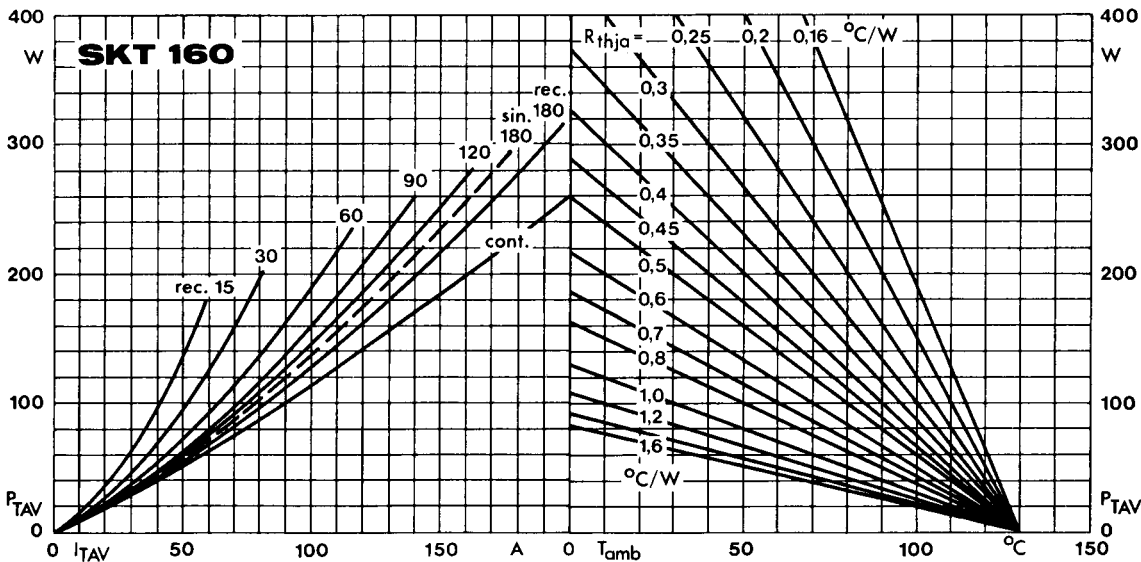

Fig. 1 b Power dissipation vs. on-state current and ambient temperature

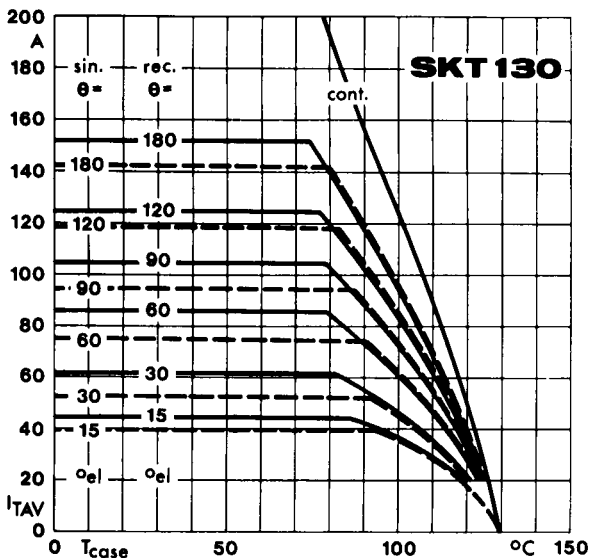

Fig. 2 a Rated on-state current vs. case temperature

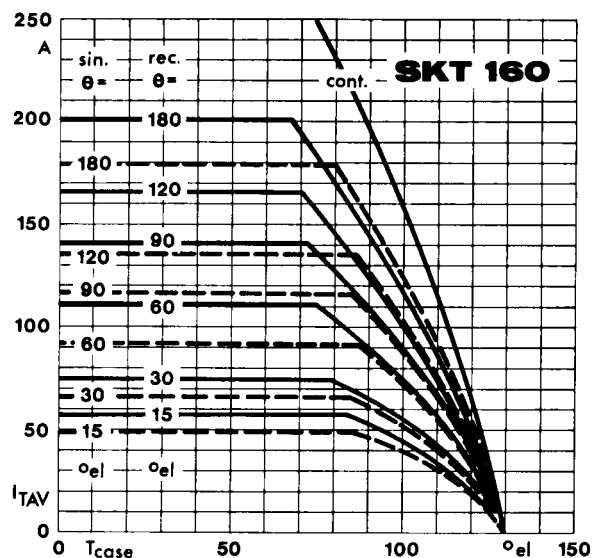

Fig. 2 b Rated on-state current vs. case temperature

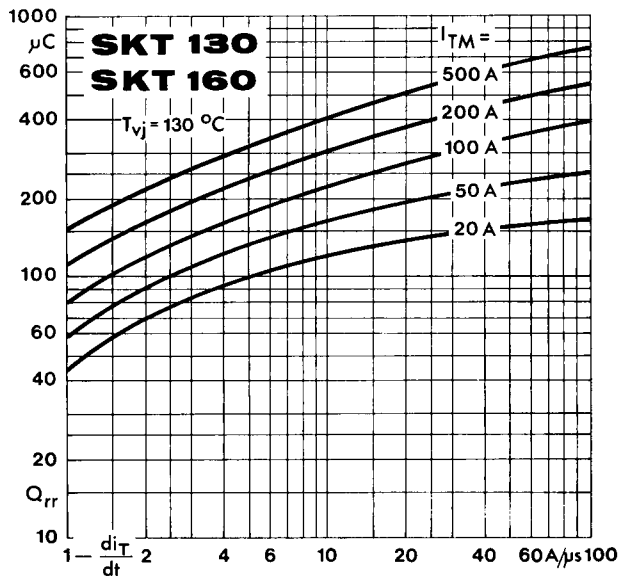

Fig. 3 Recovered charge vs. current decrease

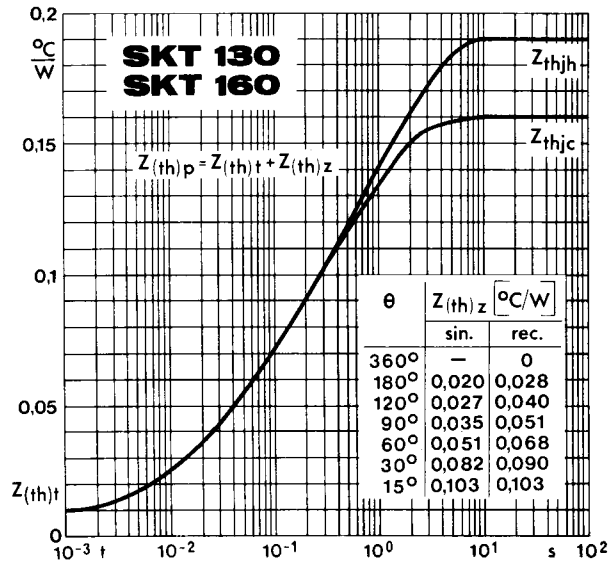

Fig. 4 Transient thermal impedance vs. time

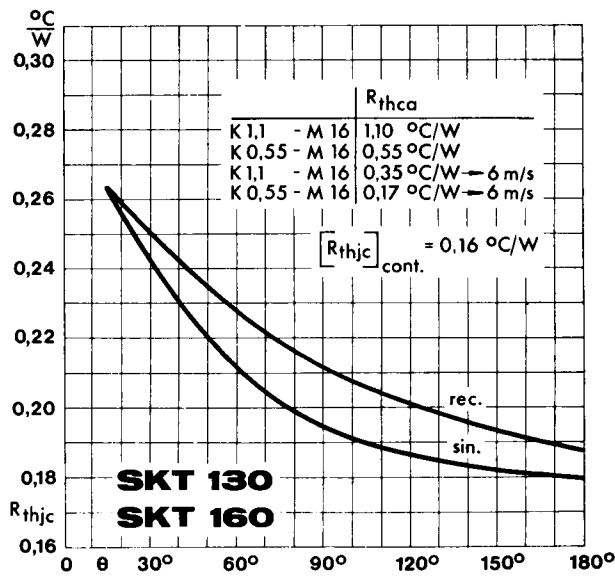

Fig. 5 Thermal resistance vs. conduction angle

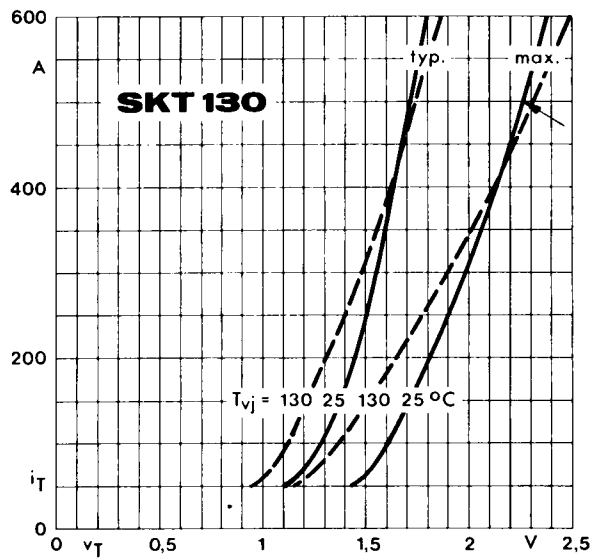

Fig. 6 a On-state characteristics

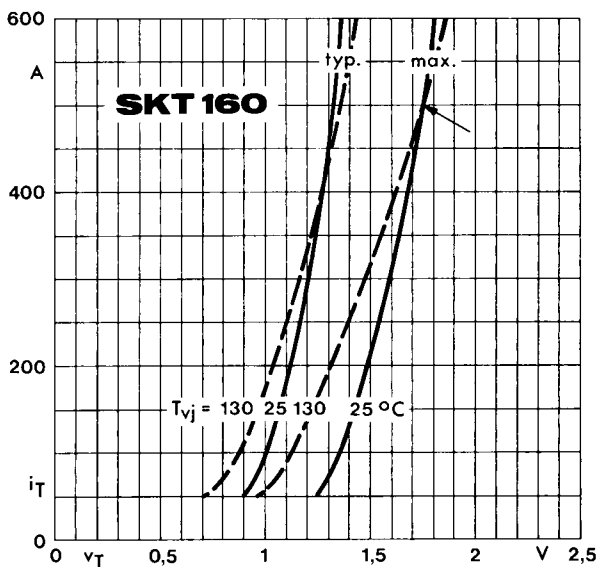

Fig. 6 b On-state characteristics

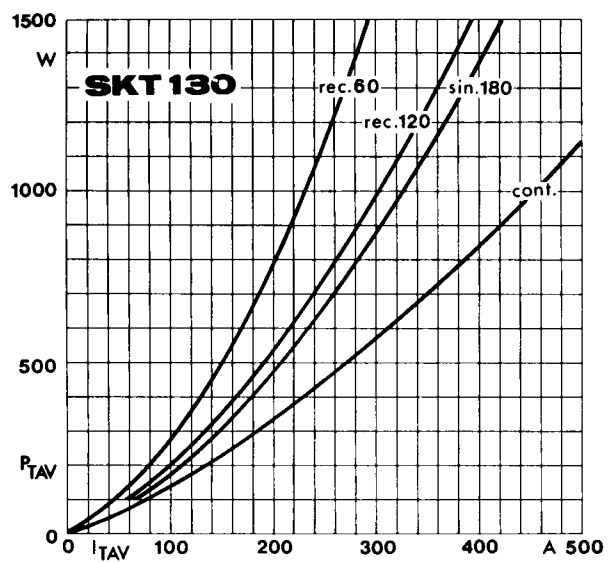

Fig. 7 a Power dissipation vs. on-state current

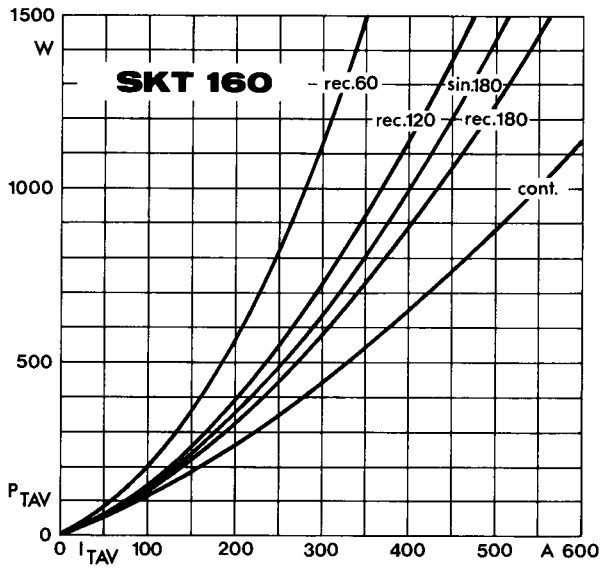

Fig. 7 b Power dissipation vs. on-state current

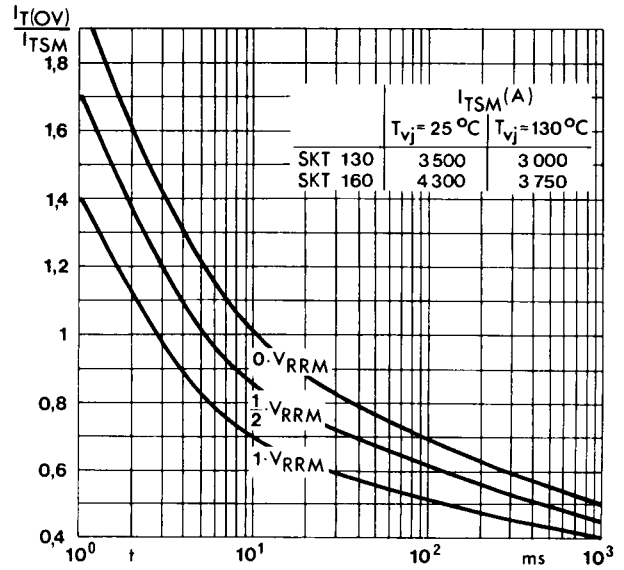

Fig. 8 Surge overload current vs. time

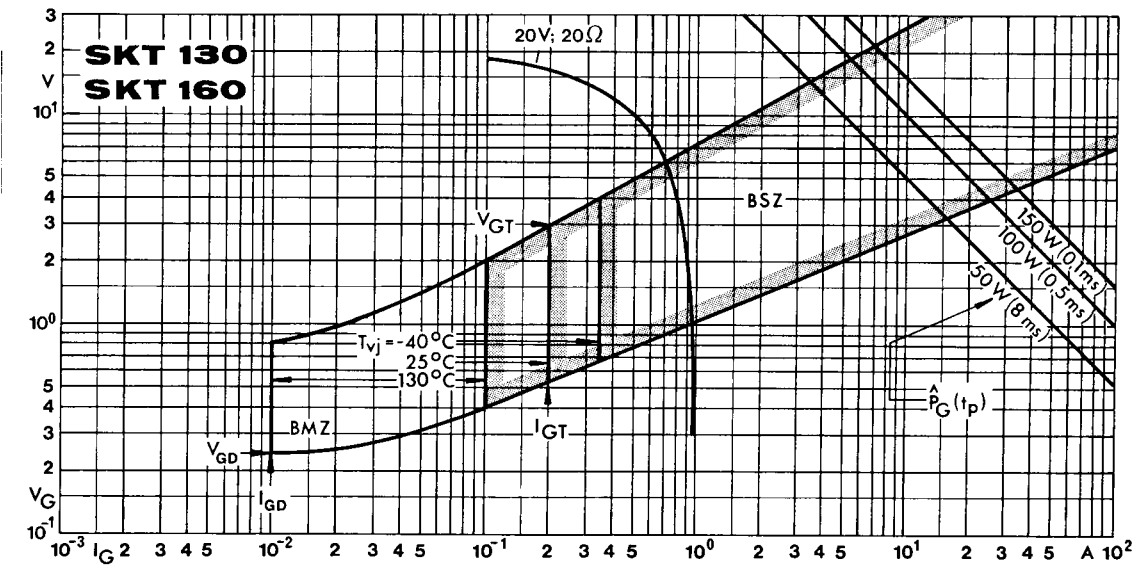

Fig. 9 Gate trigger characteristics

**SKT 55
SKT 80
SKT 100**

Case B 5

IEC-Publ. 191-2: (A 12 MA, A 12 U)

DIN 41892: (204 B 3)

BS 3934: SO – 30 C

JEDEC: TO – 209 (TO – 94)¹⁾

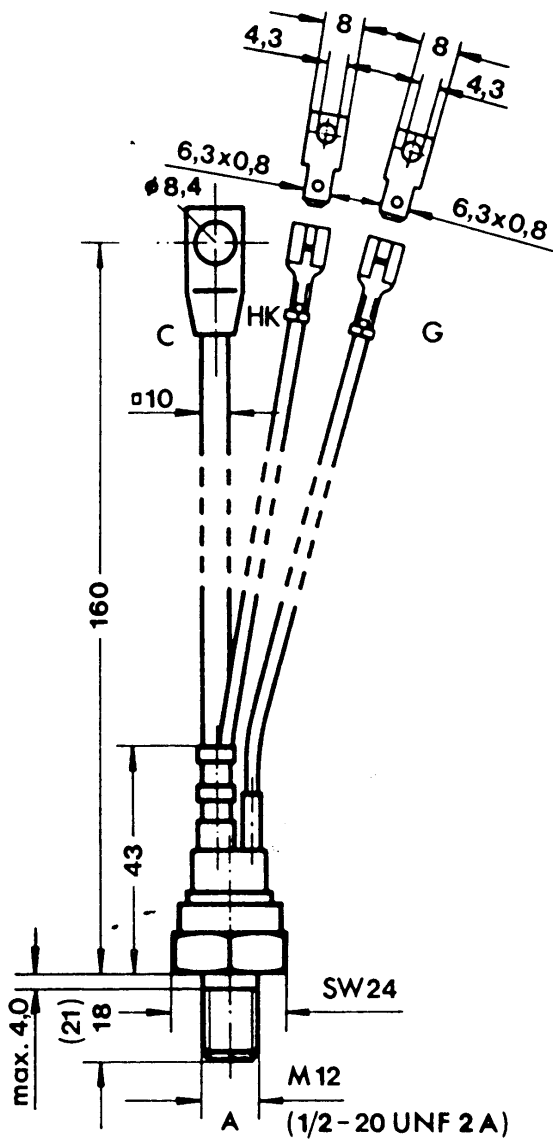

¹⁾ modified version. In the USA and Canada these types are available with the original TO-209 (TO-94) dimensions. TO-208 AD (TO-83) with flag terminals is also available.

**SKT 130
SKT 160**

Case B 6

IEC-Publ. 191-2: A 47 MC

DIN 41893: 205 B 4

JEDEC: TO-209 (TO-93)

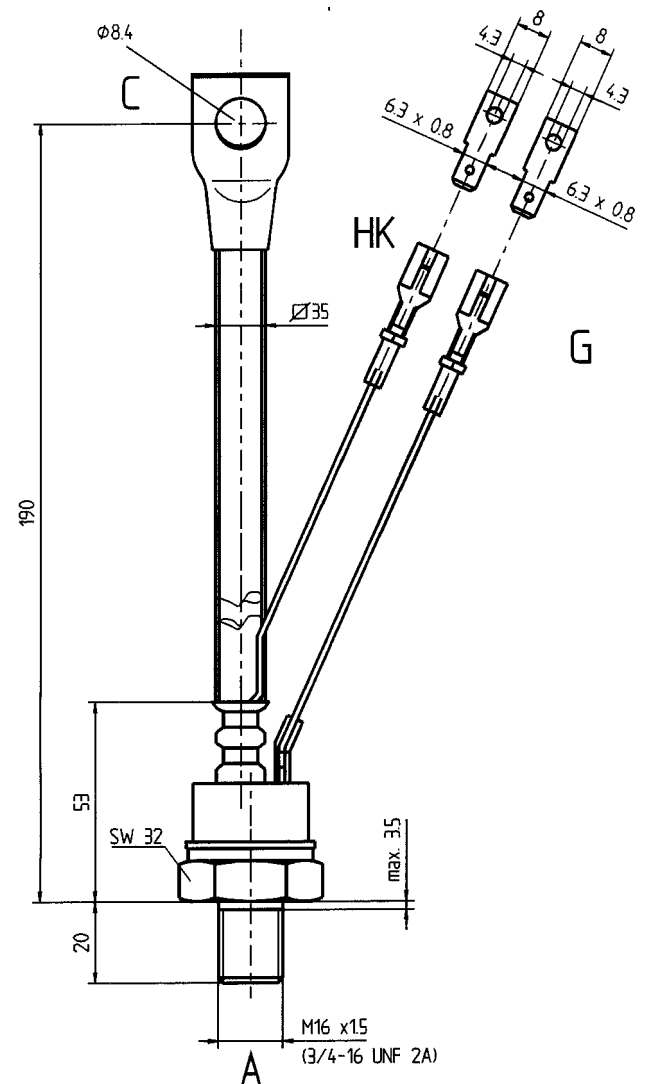

Dimensions in mm

- C: Cathode terminal (red sleeve)
- A: Anode terminal
- G: Gate terminal (yellow sleeve)
- HK: Auxiliary cathode terminal (red sleeve)