

# SKR 2F50



## Stud Diode

## Fast Recovery Rectifier Diode

### SKR 2F50

### Features

- Small recovered charge
- Soft recovery
- Up to 1000 V reverse voltage
- Hermetic metal case with glass insulator
- Threaded stud ISO M6 or 1/4-28 UNF
- SKR: cathode to stud

### Typical Applications

- Inverse diode for power transistor, GTO thyristor, asymmetric thyristor
- SMPS, inverters, choppers
- For severe ambient conditions

$V_{RSM}$ V	$V_{RRM}$ V	$I_{FRMS} = 100$ A (maximum value for continuous operation) $I_{FAV} = 50$ A (sin. 180; 5000 Hz; $T_c = 95$ °C)	
400	400	SKR 2F50/04	
400	400	SKR 2F50/04UNF	
600	600	SKR 2F50/06	
600	600	SKR 2F50/06UNF	
800	800	SKR 2F50/08	
800	800	SKR 2F50/08UNF	
1000	1000	SKR 2F50/10	
1000	1000	SKR 2F50/10UNF	

Symbol	Conditions	Values	Units
$I_{FAV}$	sin. 180; $T_c = 85$ (100) °C	57 (46)	A
$I_{FAV}$	K3; $T_a = 45$ °C; sin. 180; 5000 Hz	17	
$I_{FSM}$	$T_{vj} = 25$ °C; 10 ms	800	A
	$T_{vj} = 150$ °C; 10 ms	670	A
$i^2t$	$T_{vj} = 25$ °C; 8,3 ... 10 ms	3200	A <sup>2</sup> s
	$T_{vj} = 150$ °C; 8,3 ... 10 ms	2200	A <sup>2</sup> s
$V_F$	$T_{vj} = 25$ °C; $I_F = 50$ A	max. 1,8	V
$V_{(TO)}$	$T_{vj} = 150$ °C	1,2	V
$r_T$	$T_{vj} = 150$ °C	4	mΩ
$I_{RD}$	$T_{vj} = 25$ °C; $V_{RD} = V_{RRM}$	max. 0,4	mA
$I_{RD}$	$T_{vj} = 130$ °C; $V_{RD} = V_{RRM}$	max. 50	mA
$Q_{rr}$	$T_{vj} = 130$ °C; $I_F = 100$ A,	3	μC
$I_{RM}$	$-di/dt = 30$ A/μs; $V_R = 30$ V	10	A
$t_{rr}$		600	ns
$E_{rr}$		-	mJ
$R_{th(j-c)}$		0,65	K/W
$R_{th(c-s)}$		0,25	K/W
$T_{vj}$		- 40 ... + 150	°C
$T_{stg}$		- 55 ... + 150	°C
$V_{isol}$		-	V~
$M_s$	to heatsink	2,5	Nm
$a$		5 * 9,81	m/s <sup>2</sup>
$m$	approx.	20	g
Case		E 10	

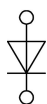

SKR

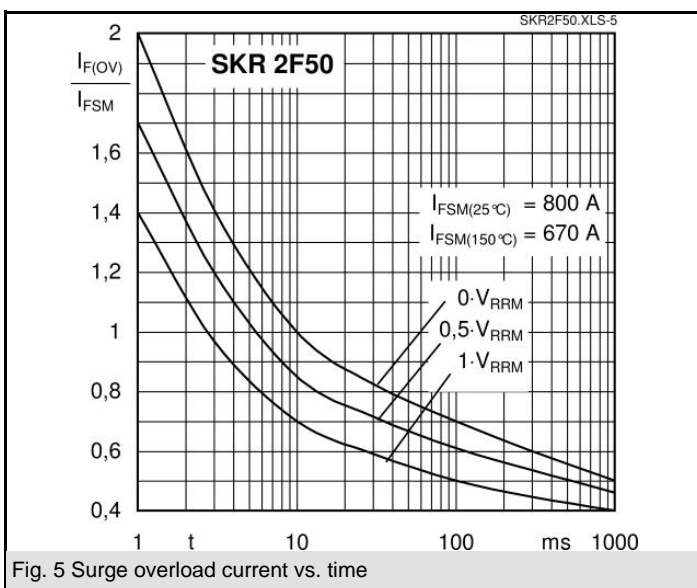
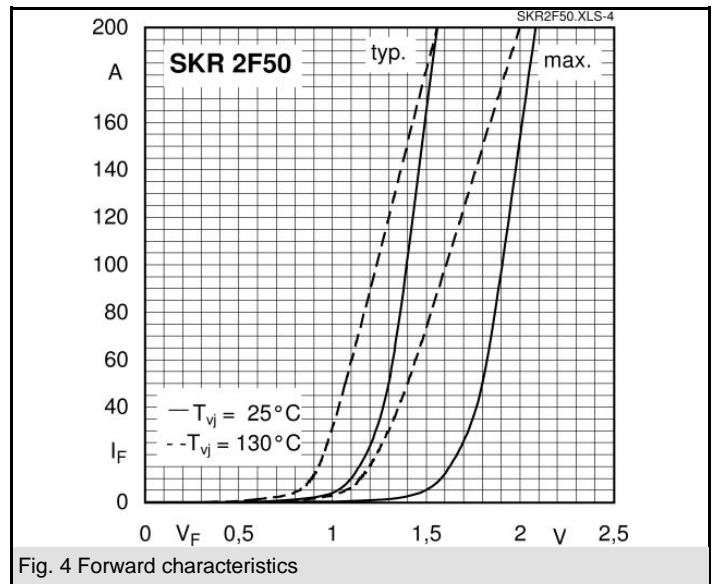
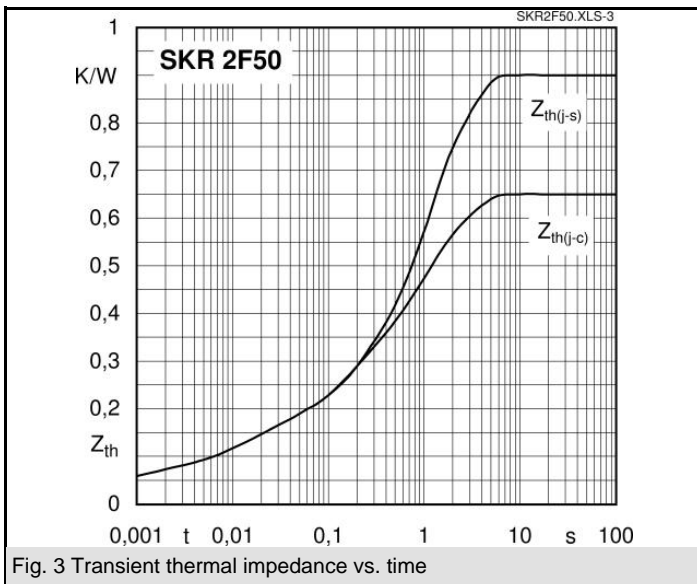
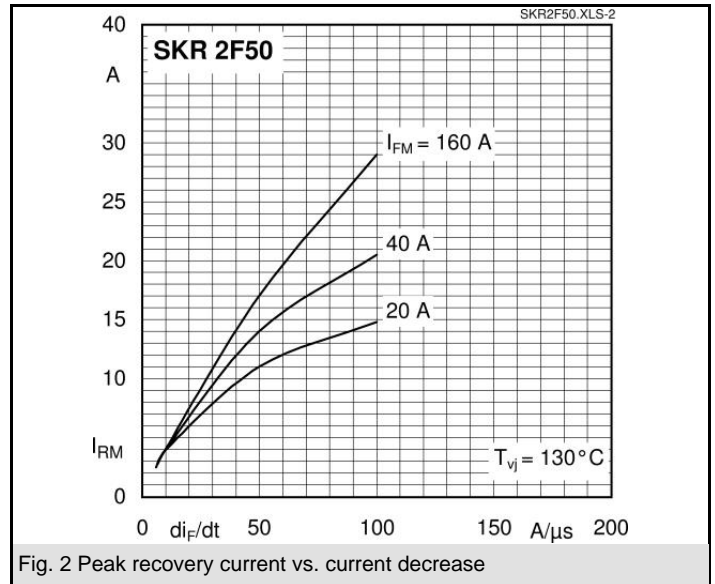
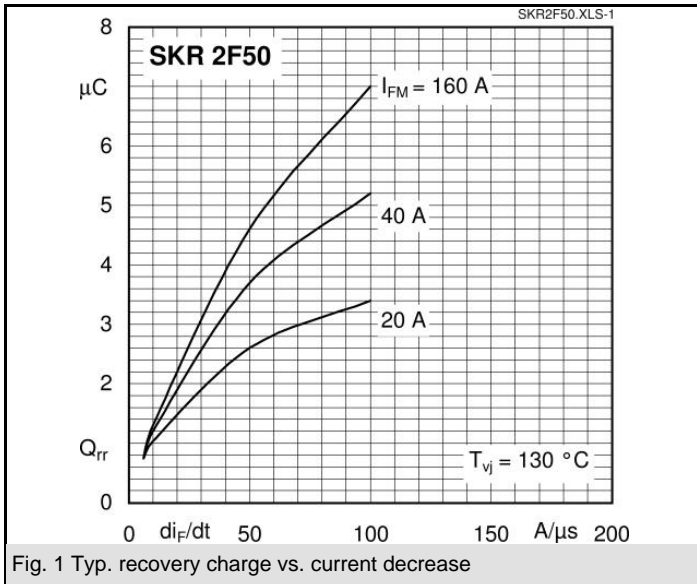

Dimensions in mm

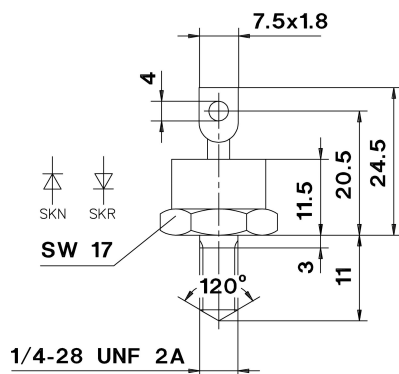
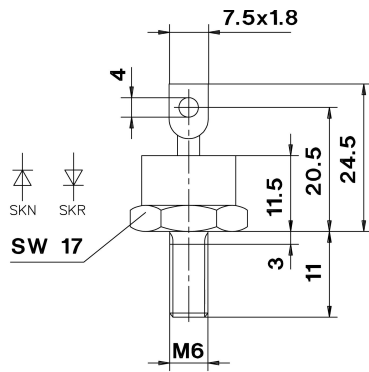

Case E 10 (IEC 60191: A 4 M, A 4 U; JEDEC: DO-203 AB (DO-5))

This technical information specifies semiconductor devices but promises no characteristics. No warranty or guarantee expressed or implied is made regarding delivery, performance or suitability.