

SKR 2F50



Stud Diode

Fast Recovery Rectifier Diode

SKR 2F50

Features

- Small recovered charge
- Soft recovery
- Up to 1000 V reverse voltage
- Hermetic metal case with glass insulator
- Threaded stud ISO M6 or 1/4-28 UNF
- SKR: cathode to stud

Typical Applications

- Inverse diode for power transistor, GTO thyristor, asymmetric thyristor
- SMPS, inverters, choppers
- For severe ambient conditions

V_{RSM} V	V_{RRM} V	$I_{FRMS} = 100$ A (maximum value for continuous operation) $I_{FAV} = 50$ A (sin. 180; 5000 Hz; $T_c = 95$ °C)	
400	400	SKR 2F50/04	
400	400	SKR 2F50/04UNF	
600	600	SKR 2F50/06	
600	600	SKR 2F50/06UNF	
800	800	SKR 2F50/08	
800	800	SKR 2F50/08UNF	
1000	1000	SKR 2F50/10	
1000	1000	SKR 2F50/10UNF	

Symbol	Conditions	Values	Units
I_{FAV}	sin. 180; $T_c = 85$ (100) °C	57 (46)	A
I_{FAV}	K3; $T_a = 45$ °C; sin. 180; 5000 Hz	17	
I_{FSM}	$T_{vj} = 25$ °C; 10 ms	800	A
	$T_{vj} = 150$ °C; 10 ms	670	A
i^2t	$T_{vj} = 25$ °C; 8,3 ... 10 ms	3200	A ² s
	$T_{vj} = 150$ °C; 8,3 ... 10 ms	2200	A ² s
V_F	$T_{vj} = 25$ °C; $I_F = 50$ A	max. 1,8	V
$V_{(TO)}$	$T_{vj} = 150$ °C	1,2	V
r_T	$T_{vj} = 150$ °C	4	mΩ
I_{RD}	$T_{vj} = 25$ °C; $V_{RD} = V_{RRM}$	max. 0,4	mA
I_{RD}	$T_{vj} = 130$ °C; $V_{RD} = V_{RRM}$	max. 50	mA
Q_{rr}	$T_{vj} = 130$ °C; $I_F = 100$ A,	3	μC
I_{RM}	$-di/dt = 30$ A/μs; $V_R = 30$ V	10	A
t_{rr}		600	ns
E_{rr}		-	mJ
$R_{th(j-c)}$		0,65	K/W
$R_{th(c-s)}$		0,25	K/W
T_{vj}		- 40 ... + 150	°C
T_{stg}		- 55 ... + 150	°C
V_{isol}		-	V~
M_s	to heatsink	2,5	Nm
a		5 * 9,81	m/s ²
m	approx.	20	g
Case		E 10	

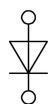

SKR

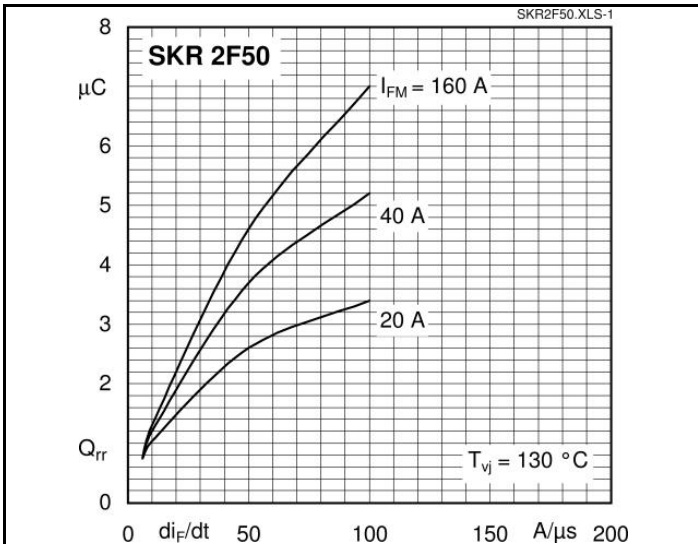

Fig. 1 Typ. recovery charge vs. current decrease

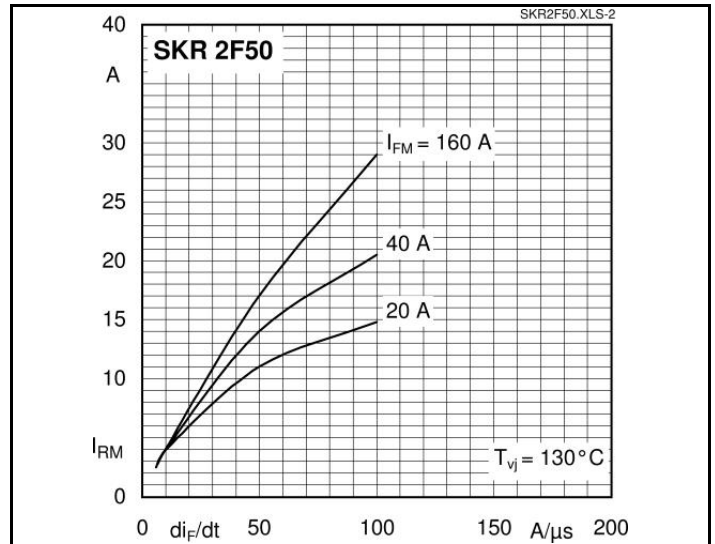

Fig. 2 Peak recovery current vs. current decrease

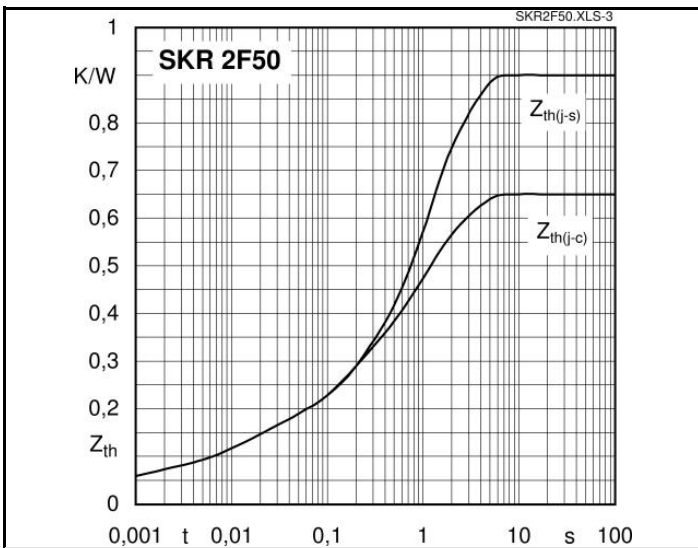

Fig. 3 Transient thermal impedance vs. time

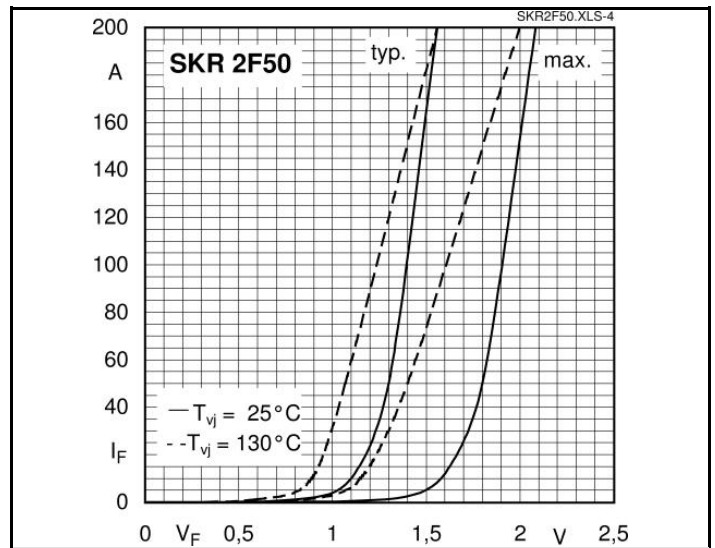

Fig. 4 Forward characteristics

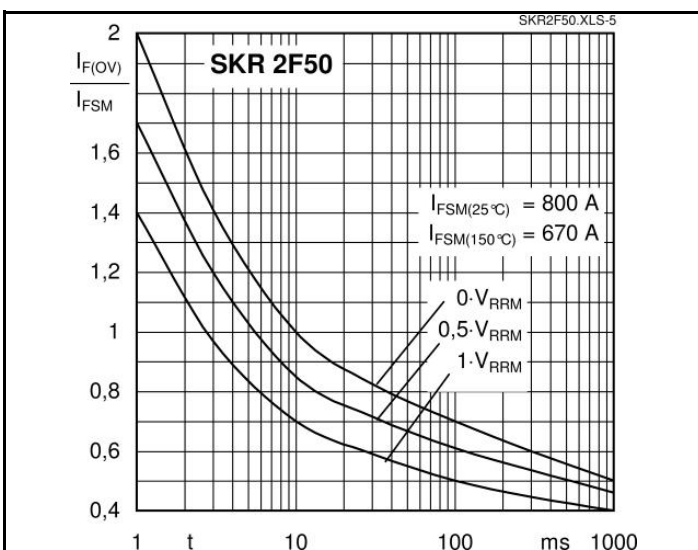
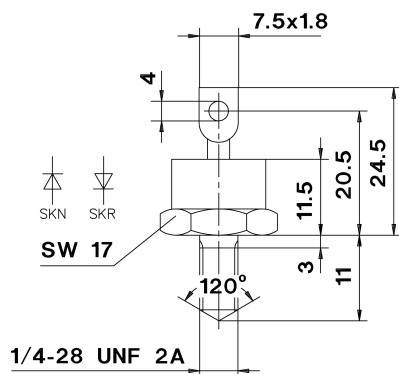
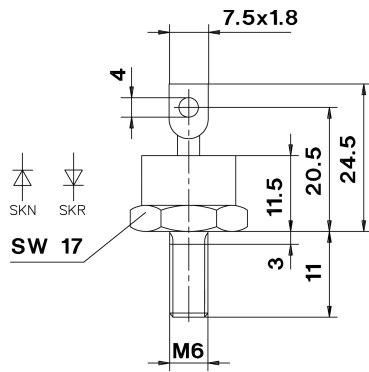

Fig. 5 Surge overload current vs. time

Dimensions in mm



Case E 10 (IEC 60191: A 4 M, A 4 U; JEDEC: DO-203 AB (DO-5))

This technical information specifies semiconductor devices but promises no characteristics. No warranty or guarantee expressed or implied is made regarding delivery, performance or suitability.