

Stud Diode

Rectifier Diode

SKN 20

SKR 20

Features

- Reverse voltages up to 1600 V
- Hermetic metal case with glass insulator
- Threaded stud ISO M6
- SKN: anode to stud, SKR: cathode to stud

Typical Applications

- All-purpose mean power rectifier diodes
- Cooling via metal plates or heatsinks
- Non-controllable and half-controllable rectifiers
- Free-wheeling diodes
- Recommended snubber network:
RC: 0,05 μ F, 200 Ω ($P_R = 1$ W),
 $R_p = 150$ k Ω ($P_R = 4$ W)

V_{RSM} V	V_{RRM} V	$I_{FRMS} = 40$ A (maximum value for continuous operation)	
		$I_{FAV} = 20$ A (sin. 180 °; $T_c = 125$ °C)	
400	400	SKN 20/04	SKR 20/04
800	800	SKN 20/08	SKR 20/08
1200	1200	SKN 20/12	SKR 20/12
1400	1400	SKN 20/14	SKR 20/14
1600	1600	SKN 20/16	SKR 20/16

Symbol	Conditions	Values	Units
I_{FAV}	sin. 180; $T_c = 100$ °C	25	A
I_D	K 9; $T_a = 45$ °C; B2 / B6	20 / 29	A
	K 3; $T_a = 45$ °C; B2 / B6	35 / 50	A
I_{FSM}	$T_{vj} = 25$ °C; 10 ms	375	A
	$T_{vj} = 180$ °C; 10 ms	320	A
i^2t	$T_{vj} = 25$ °C; 8,3 ... 10 ms	700	A ² s
	$T_{vj} = 180$ °C; 8,3 ... 10 ms	510	A ² s
V_F	$T_{vj} = 25$ °C; $I_F = 60$ A	max. 1,55	V
$V_{(TO)}$	$T_{vj} = 180$ °C	0,85	V
r_T	$T_{vj} = 180$ °C	11	m Ω
I_{RD}	$T_{vj} = 180$ °C; $V_{RD} = V_{RRM}$	max. 4	mA
Q_{rr}	$T_{vj} = 160$ °C; $-di_F/dt = 10$ A/ μ s	20	μ C
$R_{th(j-c)}$		2	K/W
$R_{th(c-s)}$		1	K/W
T_{vj}		- 40 ... + 180	°C
T_{stg}		- 55 ... + 180	°C
V_{isol}		-	V~
M_s	to heatsink	2,0	Nm
a		5 * 9,81	m/s ²
m	approx.	10	g
Case		E 9	

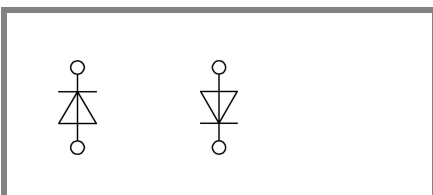

SKN

SKR

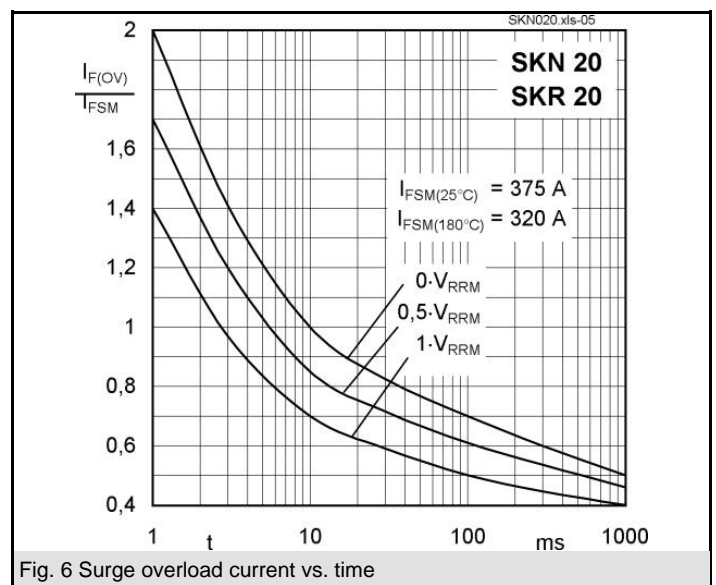
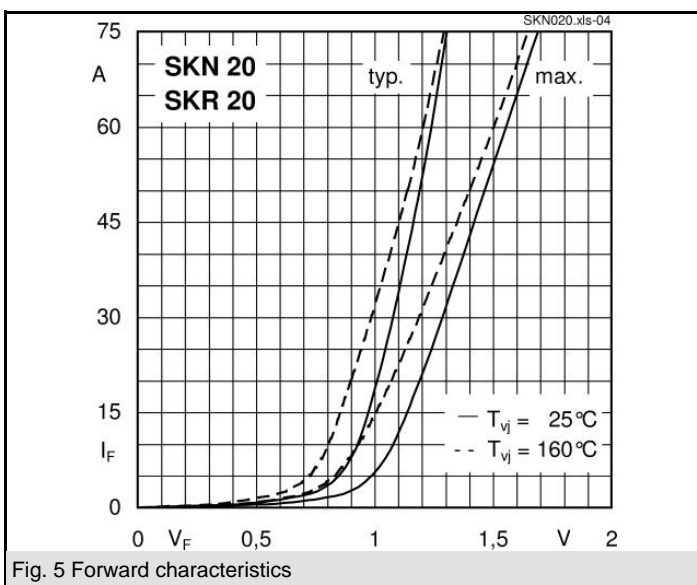
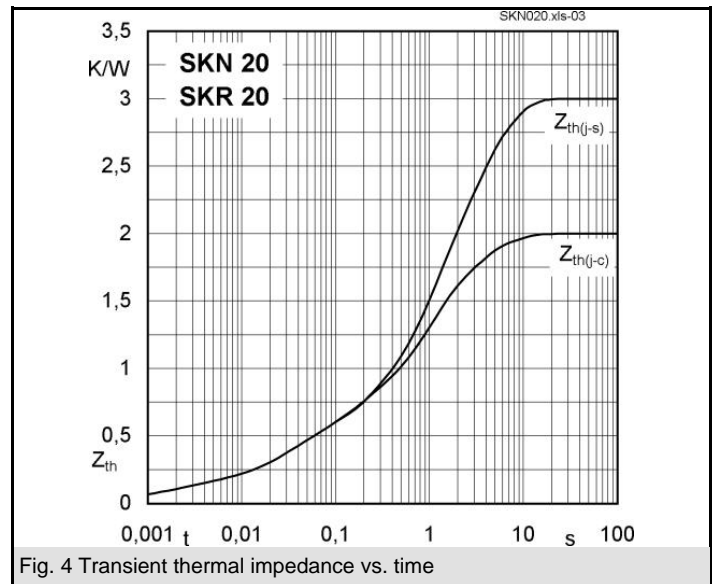
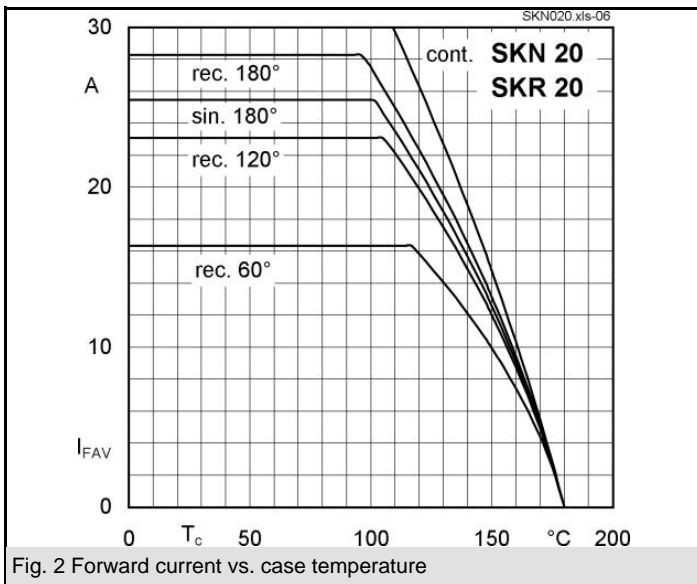
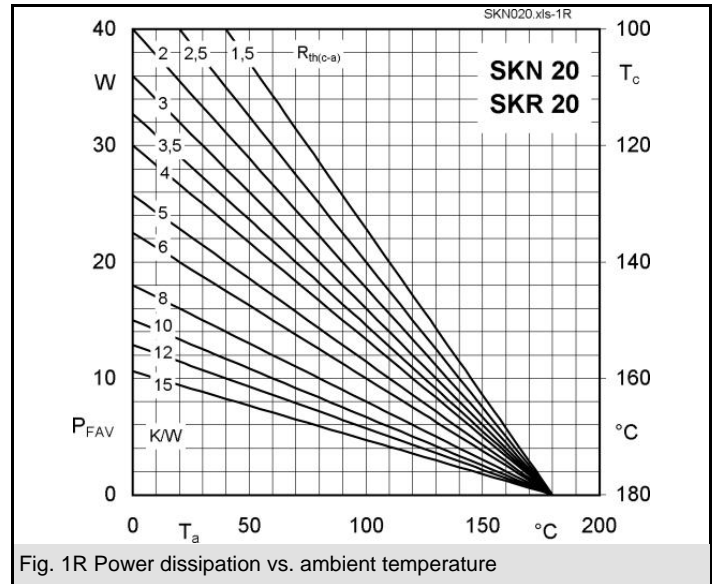
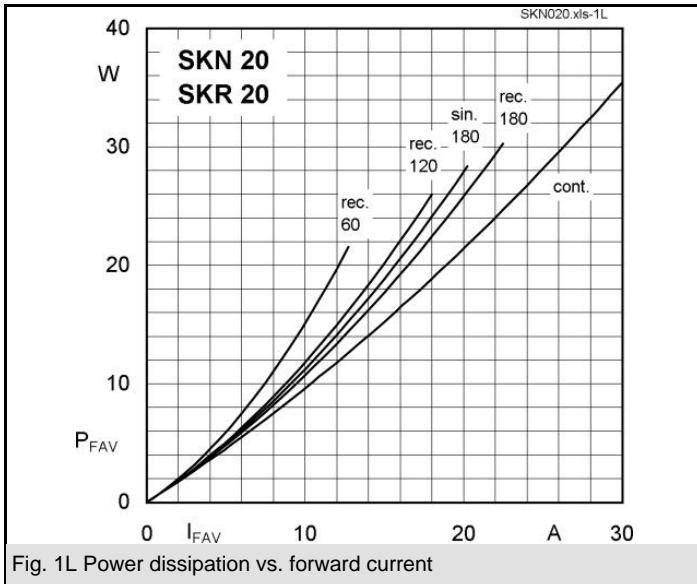

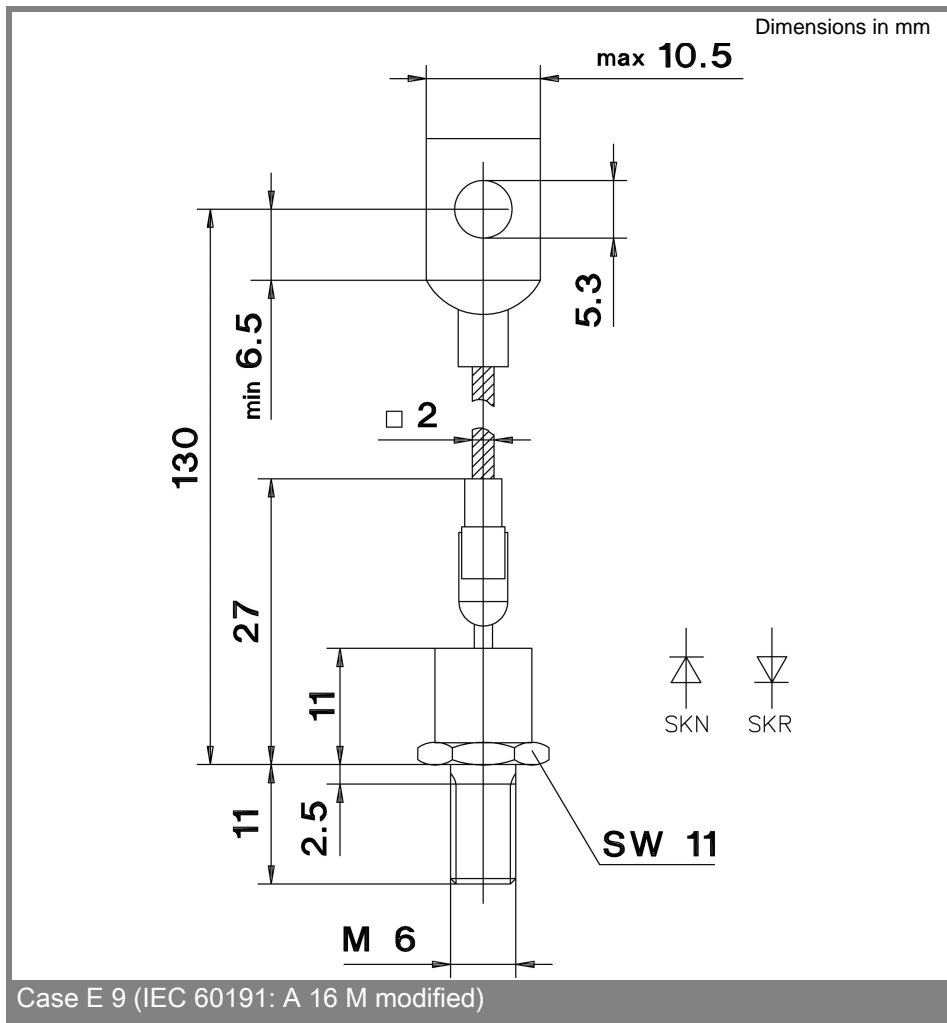

This technical information specifies semiconductor devices but promises no characteristics. No warranty or guarantee expressed or implied is made regarding delivery, performance or suitability.