

Fast Recovery Rectifier Diodes

SKN 2 F 17 SKR 2 F 17
SKN 3 F 20 SKR 3 F 20



V _{RSM} V _{RRM}	I _{FRMS} (maximum values for continuous operation)			
	41 A			
V	I _{FAV} (sin. 180; T _{case} = 85 °C)			
	26 A			
	t _{rr} = 150 ns		t _{rr} = 250 ns	
	△	▽	△	▽
400	SKN 2F17/04 SKN 2F17/04UNF	SKR 2F17/04 SKR 2F17/04UNF	-	-
600	SKN 2F17/06 SKN 2F17/06UNF	SKR 2F17/06 SKR 2F17/06UNF	-	-
800	SKN 2F17/08 SKN 2F17/08UNF	SKR 2F17/08 SKR 2F17/08UNF	SKN 3F20/08 SKN 3F20/08UNF	SKR 3F20/08 SKR 3F20/08UNF
1000	SKN 2F17/10 SKN 2F17/10UNF	SKR 2F17/10 SKR 2F17/10UNF	SKN 3F20/10 SKN 3F20/10UNF	SKR 3F20/10 SKR 3F20/10UNF
1200	-	-	SKN 3F20/12 SKN 3F20/12UNF	SKR 3F20/12 SKR 3F20/12UNF

Symbol	Conditions	SKN 2 F 17 SKR 2 F 17	SKN 3 F 20 SKR 3 F 20	Units
I _{FAV}	sin. 180; T _{case} = 85 °C; f=5000 Hz = 104 °C = 113 °C sin. 180/rec. 120; T _{amb} = 5 °C; K9 K5	26 - 17	26 20 -	A A A A A
I _{FSM}	T _{vj} = 25 °C; 10 ms T _{vj} = 150 °C; 10 ms	450 380	375 310	A A
i ² t	T _{vj} = 25 °C; 8,3 ... 10 ms T _{vj} = 150 °C; 8,3 ... 10 ms	1000 720	700 480	A ² s A ² s
Q _{rr}	T _{vj} = 130 °C; I _F = 50 A;	1,0	1,5	μC
I _{RM}	$-\frac{dI_F}{dt} = 15 \frac{A}{\mu s}$; V _R = 30 V	4,5	5	A
I _R	T _{vj} = 25 °C; V _R = V _{RRM} T _{vj} = 130 °C; V _R = V _{RRM}	max. 0,2 max. 16	max. 0,2 max. 20	mA mA
t _{rr}	T _{vj} = 25 °C } I _F = I _R = 1 A T _{vj} = 130 °C }	max. 150 typ. 300	max. 250 typ. 500	ns ns
V _F	T _{vj} = 25 °C; I _F = 50 A	max. 2,15		V
V _(TO)	T _{vj} = 130 °C	1,3		V
r _T	T _{vj} = 130 °C	12		mΩ
R _{thjc}		1,2		°C/W
R _{thch}		0,5		°C/W
T _{vj}		- 40 ... + 150		°C
T _{stg}		- 55 ... + 150		°C
M	SI units US units	1,5 13		Nm lb.in.
a		5 · 9,81		m/s ²
w		7		g
Case		E7		

Features

- Small recovered charge
- Soft recovery
- Up to 1200 V reverse voltage
- Hermetic metal cases with glass insulators
- Threaded studs ISO M5 or 10-32 UNF
- **SKN**: anode to stud
SKR: cathode to stud

Typical Applications

- Inverse diodes for power transistors, GTO thyristors asymmetric thyristors
- SMPS, inverters, choppers
- For severe ambient conditions

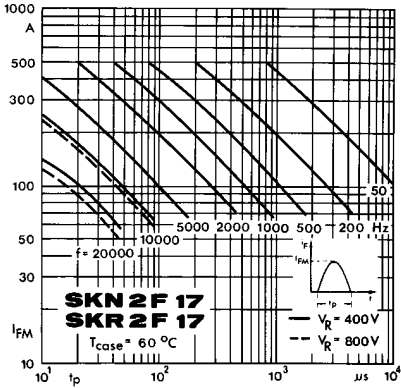

Fig. 1 a Rated sinusoidal peak forward current

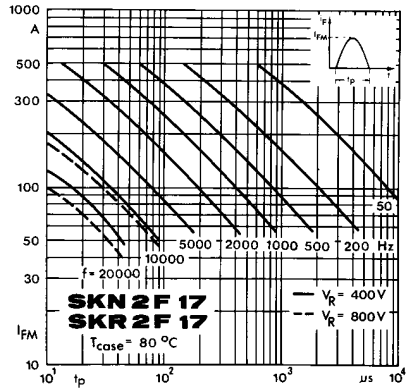

Fig. 1 b Rated sinusoidal peak forward current

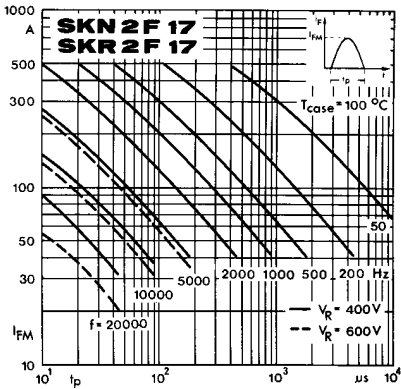

Fig. 1 c Rated sinusoidal peak forward current

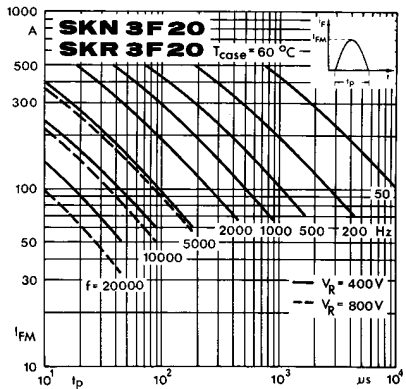

Fig. 1 d Rated sinusoidal peak forward current

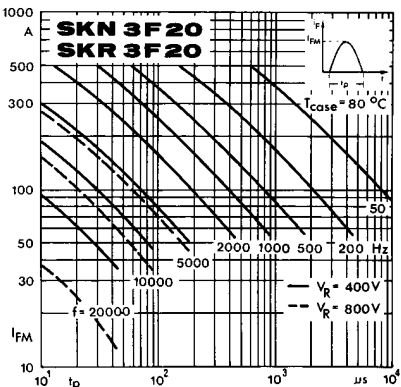

Fig. 1 e Rated sinusoidal peak forward current

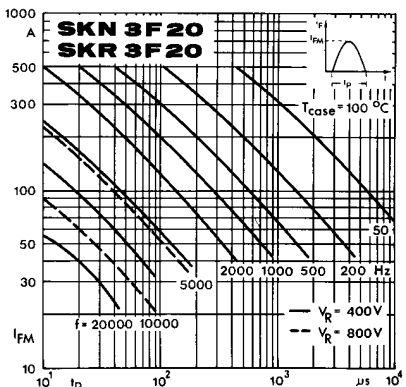

Fig. 1 f Rated sinusoidal peak forward current

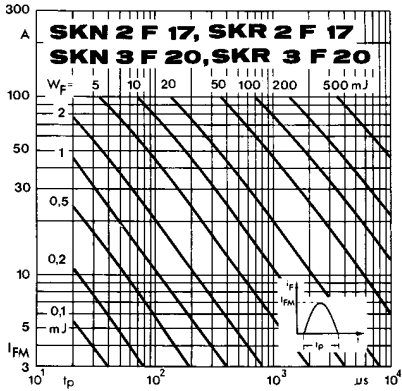

Fig. 2 Forward energy dissipation, sinusoidal

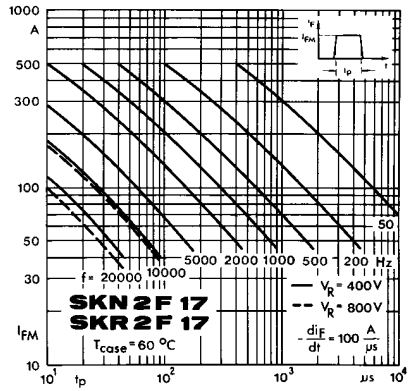

Fig. 3 a Rated rectangular peak forward current

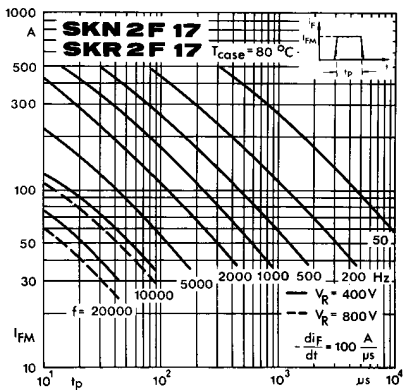

Fig. 3 b Rated rectangular peak forward current

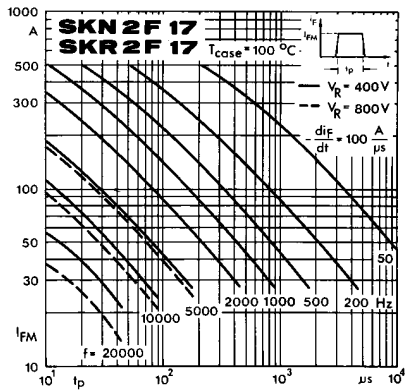

Fig. 3 c Rated rectangular peak forward current

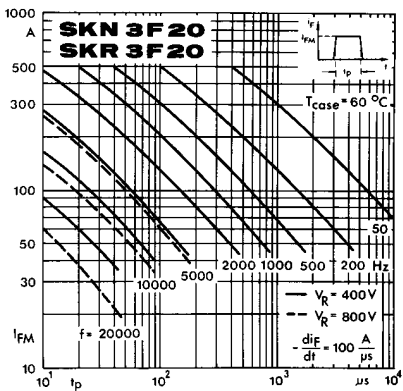

Fig. 3 d Rated rectangular peak forward current

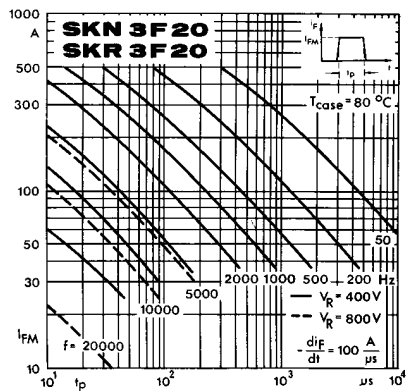

Fig. 3 e Rated rectangular peak forward current

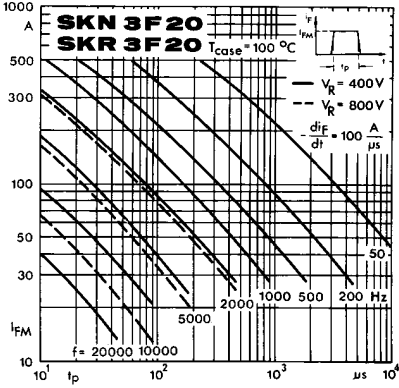

Fig. 3 f Rated rectangular peak forward current

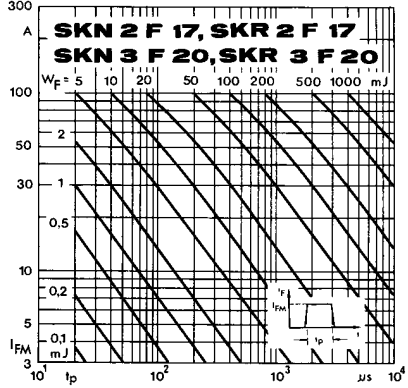

Fig. 4 Forward energy dissipation, rectangular

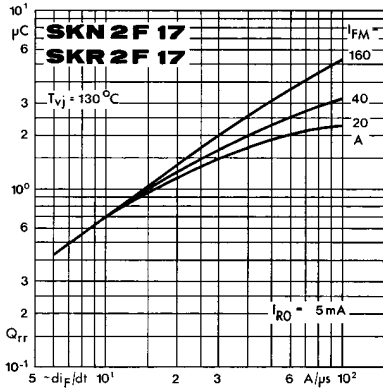

Fig. 5 a Recovered charge

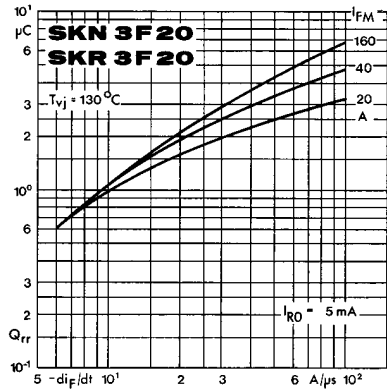

Fig. 5 b Recovered charge

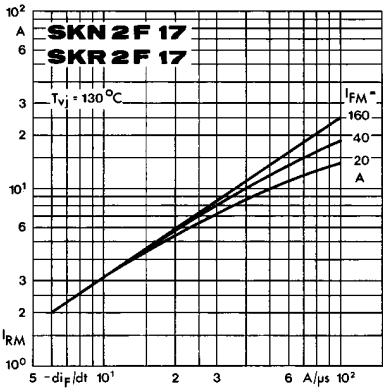

Fig. 6 a Peak reverse recovery current

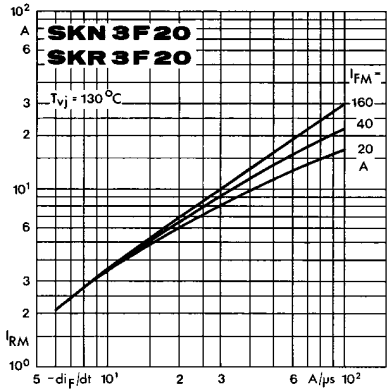

Fig. 6 b Peak reverse recovery current

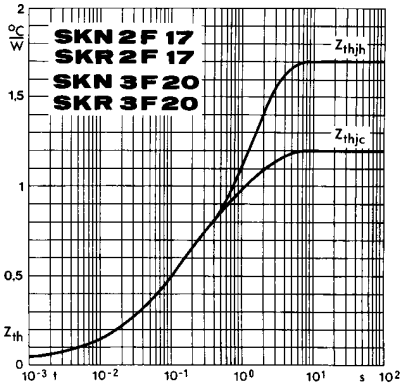

Fig. 7 Transient thermal impedance

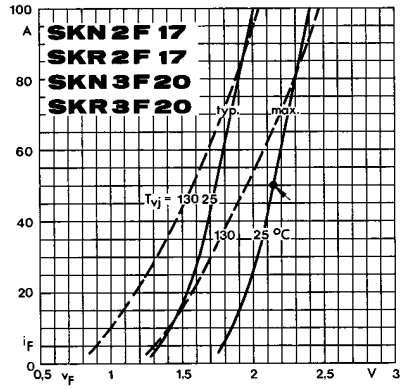

Fig. 8 Forward characteristics

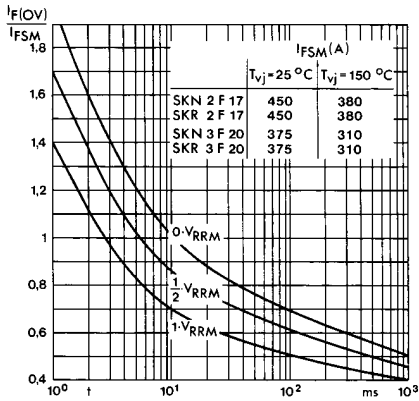
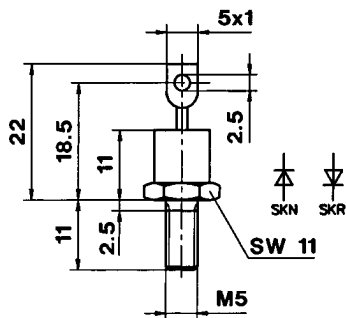

Fig 9 Rated surge overload current

SKN 2 F 17
SKR 2 F 17
SKN 3 F 20
SKR 3 F 20

Case E 7

IEC-Publ. 191-2: A 3 M
DIN 41 885: 101 C 2
BS 3934: SO-10
JEDEC: DO-203 AA (DO-4) metric



Dimensions in mm

SKN 2 F 17 ... UNF
SKR 2 F 17 ... UNF
SKN 3 F 20 ... UNF
SKR 3 F 20 ... UNF

Case E 7 UNF

IEC-Publ. 191-2: A 3 U
BS 3934: SO-10
JEDEC: DO-203 AA (DO-4)

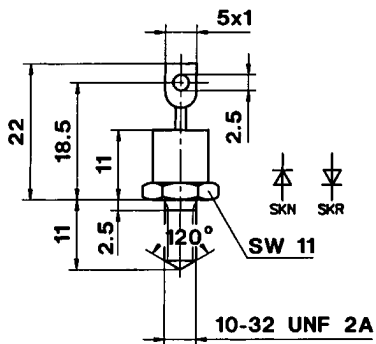

Dimensions in mm