



SEMITRANS®3

Fast IGBT4 Modules

SKM300GB12T4

Features

- IGBT4 = 4. Generation (Trench)IGBT
- VCEsat with positive temperature coefficient
- High short circuit capability, self limiting to 6 x I_{CNOM}
- Soft switching 4. Generation CAL diode (CAL4)

Typical Applications

- AC inverter drives
- UPS
- Electronic welders at fsw up to 20 kHz

Remarks

- Case temperature limited to T_c = 125°C max, recomm. Top = -40 ... +150°C, product rel. results valid for T_j = 150°

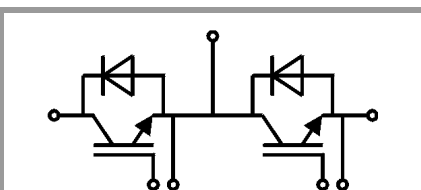

GB

Absolute Maximum Ratings				
Symbol	Conditions	Values	Unit	
IGBT				
V _{CES}		1200	V	
I _C	T _j = 175 °C	T _c = 25 °C	422	A
		T _c = 80 °C	324	A
I _{Cnom}		300	A	
I _{CRM}	I _{CRM} = 3xI _{Cnom}	900	A	
V _{GES}		-20 ... 20	V	
t _{psc}	V _{CC} = 800 V	T _j = 150 °C	10	µs
	V _{GE} ≤ 15 V			
	V _{CES} ≤ 1200 V			
T _j		-40 ... 175		°C
Inverse diode				
I _F	T _j = 175 °C	T _c = 25 °C	353	A
		T _c = 80 °C	264	A
I _{Fnom}		300	A	
I _{FRM}	I _{FRM} = 3xI _{Fnom}	900	A	
I _{FSM}	t _p = 10 ms, sin 180°, T _j = 25 °C	1548	A	
T _j		-40 ... 175		°C
Module				
I _{t(RMS)}		500		A
T _{stg}		-40 ... 125		°C
V _{isol}	AC sinus 50Hz, t = 1 min	4000		V

Characteristics					
Symbol	Conditions	min.	typ.	max.	Unit
IGBT					
V _{CE(sat)}	I _C = 300 A V _{GE} = 15 V chipelevel	T _j = 25 °C	1.85	2.1	V
		T _j = 150 °C	2.25	2.45	V
V _{CE0}		T _j = 25 °C	0.8	0.9	V
		T _j = 150 °C	0.7	0.8	V
r _{CE}	V _{GE} = 15 V	T _j = 25 °C	3.5	4.0	mΩ
		T _j = 150 °C	5.2	5.5	mΩ
V _{GE(th)}	V _{GE} =V _{CE} , I _C = 12 mA	5	5.8	6.5	V
I _{CES}	V _{GE} = 0 V V _{CE} = 1200 V	T _j = 25 °C	0.1	0.3	mA
		T _j = 150 °C			mA
C _{ies}	V _{CE} = 25 V	f = 1 MHz	17.6		nF
C _{oes}	V _{GE} = 0 V	f = 1 MHz	1.16		nF
C _{res}		f = 1 MHz	0.94		nF
Q _G	V _{GE} = - 8 V...+ 15 V		1700		nC
R _{Gint}	T _j = 25 °C		2.5		Ω
t _{d(on)}	V _{CC} = 600 V	T _j = 150 °C	200		ns
t _r	I _C = 300 A V _{GE} = ±15 V	T _j = 150 °C	44		ns
E _{on}	R _{G on} = 1.5 Ω	T _j = 150 °C	27		mJ
t _{d(off)}	R _{G off} = 1.5 Ω	T _j = 150 °C	450		ns
t _f	di/dt _{on} = 7500 A/µs	T _j = 150 °C	90		ns
E _{off}	di/dt _{off} = 3350 A/µs	T _j = 150 °C	29		mJ
R _{th(j-c)}	per IGBT			0.11	K/W



SEMITRANS®3

Fast IGBT4 Modules

SKM300GB12T4

Features

- IGBT4 = 4. Generation (Trench)IGBT
- VCEsat with positive temperature coefficient
- High short circuit capability, self limiting to $6 \times I_{CNOM}$
- Soft switching 4. Generation CAL diode (CAL4)

Typical Applications

- AC inverter drives
- UPS
- Electronic welders at fsw up to 20 kHz

Remarks

- Case temperature limited to $T_c = 125^\circ\text{C}$ max, recomm.
Top = $-40 \dots +150^\circ\text{C}$, product rel. results valid for $T_j = 150^\circ$

Characteristics						
Symbol	Conditions		min.	typ.	max.	Unit
Inverse diode						
$V_F = V_{EC}$	$I_F = 300\text{ A}$ $V_{GE} = 0\text{ V}$ chip	$T_j = 25^\circ\text{C}$		2.17	2.49	V
		$T_j = 150^\circ\text{C}$		2.11	2.42	V
V_{F0}		$T_j = 25^\circ\text{C}$		1.3	1.5	V
		$T_j = 150^\circ\text{C}$		0.9	1.1	V
r_F		$T_j = 25^\circ\text{C}$		2.9	3.3	m Ω
		$T_j = 150^\circ\text{C}$		4.0	4.4	m Ω
I_{RRM}	$I_F = 300\text{ A}$ $di/dt_{off} = 7300\text{ A}/\mu\text{s}$ $V_{GE} = \pm 15\text{ V}$ $V_{CC} = 600\text{ V}$	$T_j = 150^\circ\text{C}$		345		A
Q_{rr}		$T_j = 150^\circ\text{C}$		54		μC
E_{rr}		$T_j = 150^\circ\text{C}$			23	
$R_{th(j-c)}$	per diode				0.17	K/W
Module						
L_{CE}				15	20	nH
$R_{CC'+EE'}$	terminal-chip	$T_c = 25^\circ\text{C}$		0.25		m Ω
		$T_c = 125^\circ\text{C}$		0.5		m Ω
$R_{th(c-s)}$	per module			0.02	0.038	K/W
M_s	to heat sink M6			3	5	Nm
M_t		to terminals M6		2.5	5	Nm
						Nm
w					325	g

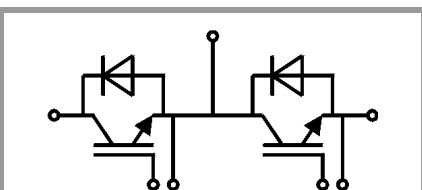

GB

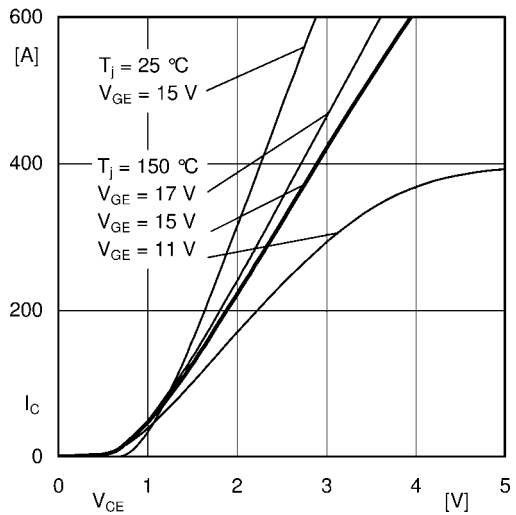

Fig. 1: Typ. output characteristic, inclusive $R_{CC'+EE'}$

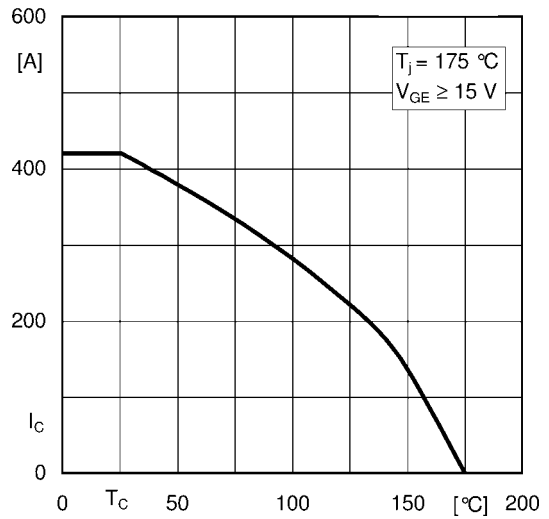

Fig. 2: Rated current vs. temperature $I_C = f(T_C)$

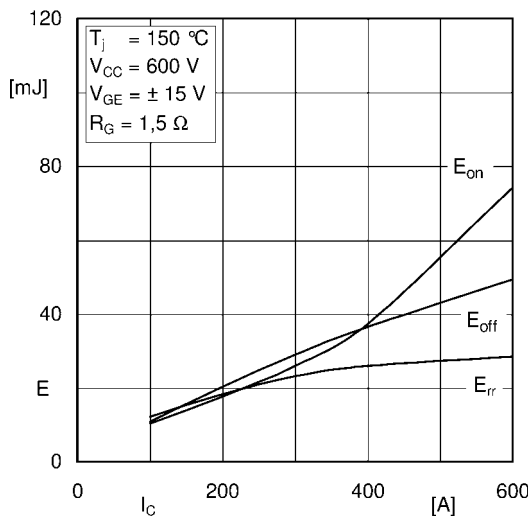

Fig. 3: Typ. turn-on /-off energy = $f(I_C)$

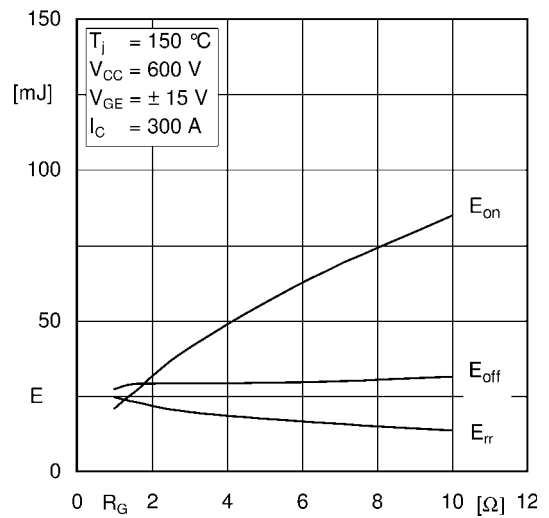

Fig. 4: Typ. turn-on /-off energy = $f(R_G)$

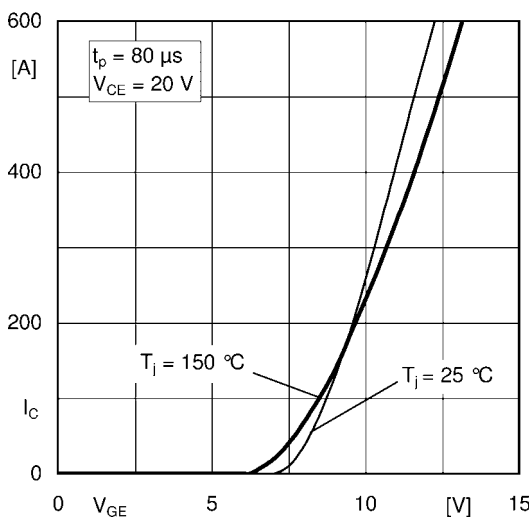

Fig. 5: Typ. transfer characteristic

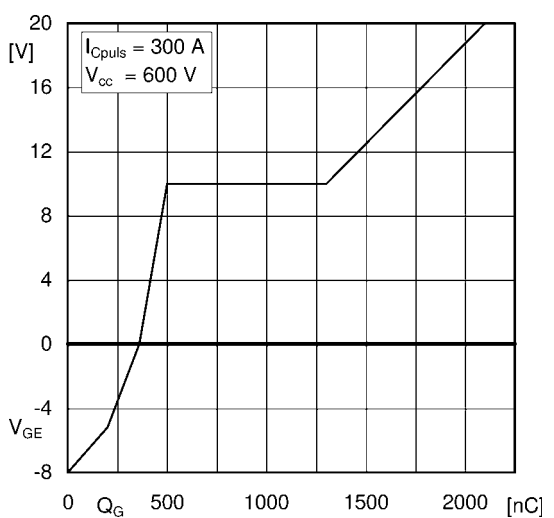

Fig. 6: Typ. gate charge characteristic

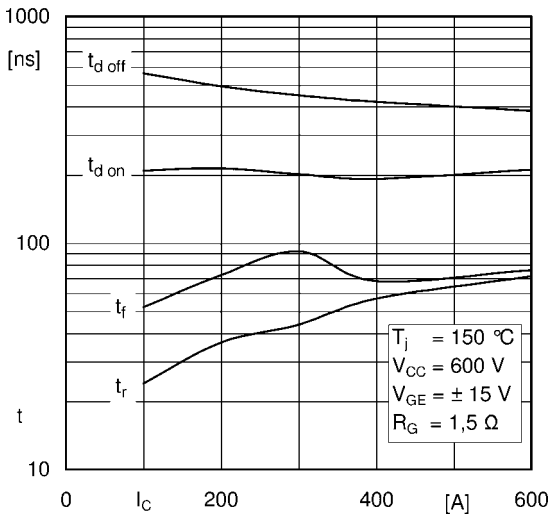

Fig. 7: Typ. switching times vs. I_C

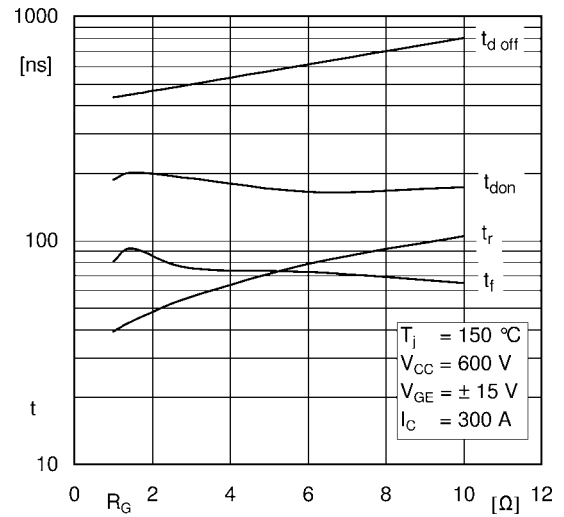

Fig. 8: Typ. switching times vs. gate resistor R_G

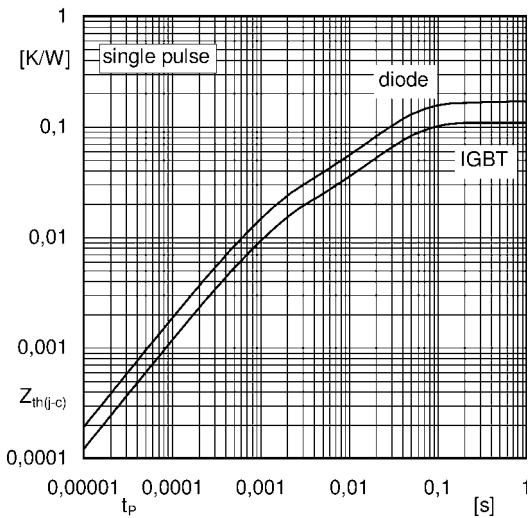

Fig. 9: Transient thermal impedance

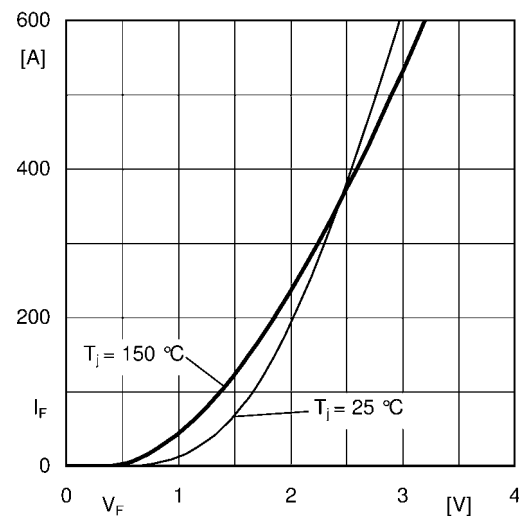

Fig. 10: CAL diode forward characteristic

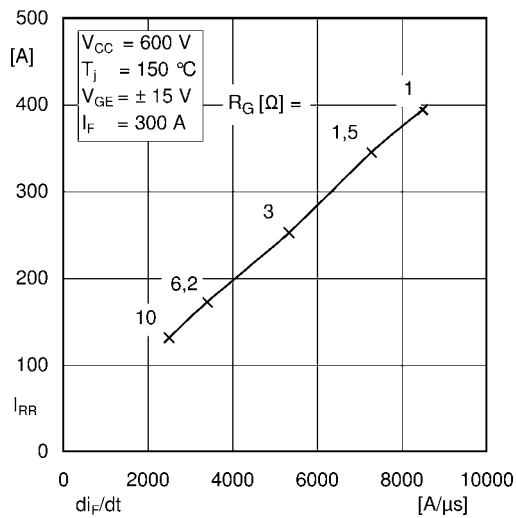

Fig. 11: CAL diode peak reverse recovery current

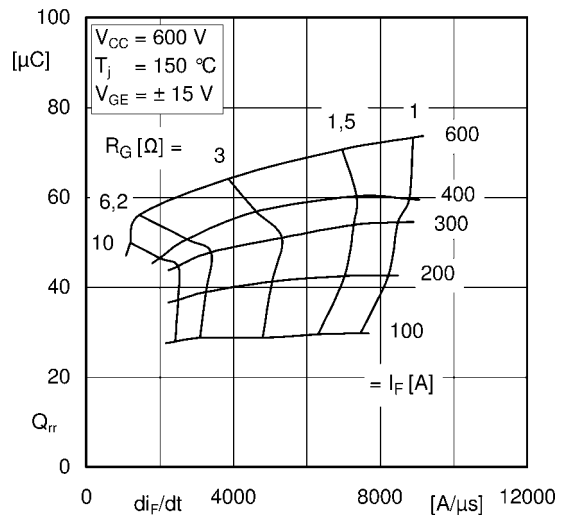
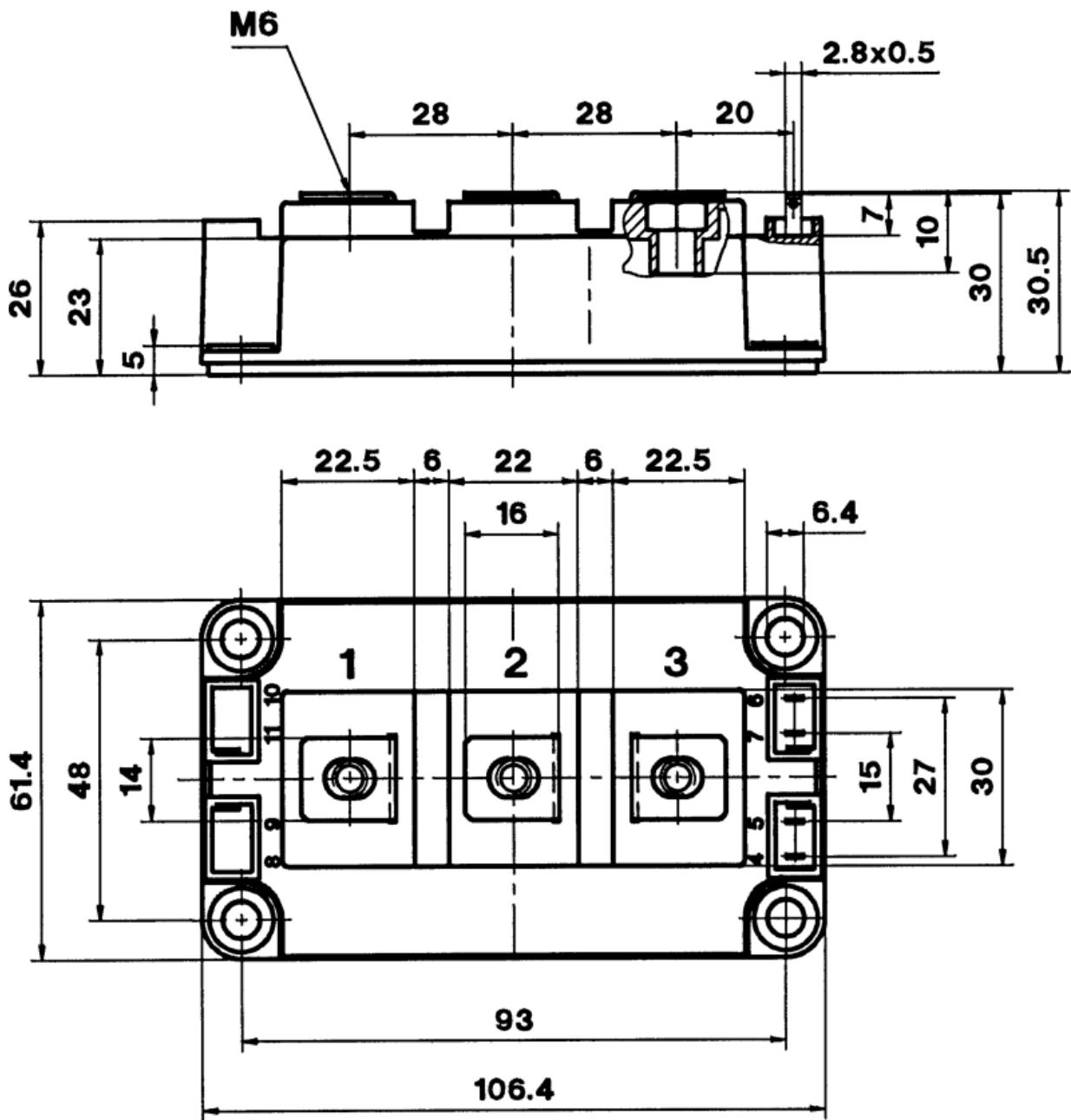
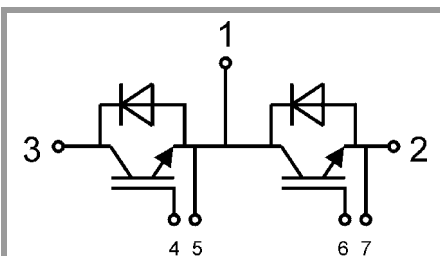

Fig. 12: Typ. CAL diode peak reverse recovery charge



Semitrans 3



GB

This is an electrostatic discharge sensitive device (ESDS), international standard IEC 60747-1, Chapter IX.

This technical information specifies semiconductor devices but promises no characteristics. No warranty or guarantee expressed or implied is made regarding delivery, performance or suitability.