

SKM 300GB066D

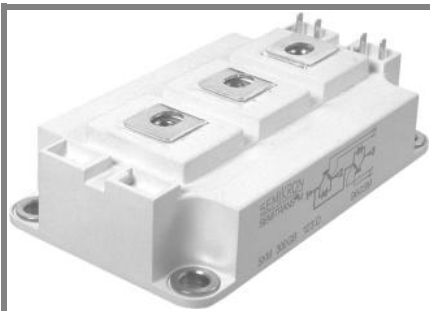

SEMITRANS® 3

Trench IGBT Modules

SKM 300GB066D

Features

- Homogeneous Si
- Trench = Trenchgate technology
- $V_{CE(sat)}$ with positive temperature coefficient
- High short circuit capability, self limiting to $6 \times I_C$

Typical Applications*

- AC inverter drives
- UPS
- Electronic welders

Remarks

- Case temperature limited to $T_C = 125^\circ\text{C}$ max, recommended $T_{op} = -40 \dots +150^\circ\text{C}$
- Product reliability results are valid for $T_j \leq 150^\circ\text{C}$
- Short circuit data: $t_p \leq 6\mu\text{s}$; $V_{GE} \leq 15\text{V}$; $T_j = 150^\circ\text{C}$; $V_{CC} \leq 360\text{V}$, use of soft R_G necessary!
- Take care of over-voltage caused by stray inductances

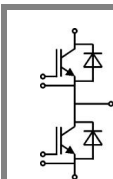

GB

Absolute Maximum Ratings		$T_{case} = 25^\circ\text{C}$, unless otherwise specified		
Symbol	Conditions	Values	Units	
IGBT				
V_{CES}	$T_j = 25^\circ\text{C}$	600	V	
I_C	$T_j = 175^\circ\text{C}$	$T_c = 25^\circ\text{C}$	390	A
		$T_c = 80^\circ\text{C}$	300	A
I_{CRM}	$I_{CRM} = 2 \times I_{Cnom}$	600	A	
V_{GES}		± 20	V	
t_{psc}	$V_{CC} = 360\text{V}$; $V_{GE} \leq 15\text{V}$; $T_j = 150^\circ\text{C}$ $V_{CES} < 600\text{V}$	6	μs	
Inverse Diode				
I_F	$T_j = 175^\circ\text{C}$	$T_c = 25^\circ\text{C}$	350	A
		$T_c = 80^\circ\text{C}$	250	A
I_{FRM}	$I_{FRM} = 2 \times I_{Fnom}$	600	A	
I_{FSM}	$t_p = 10\text{ms}$; sin.	$T_j = 175^\circ\text{C}$	1760	A
Module				
$I_{t(RMS)}$		500	A	
T_{vj}		-40 ... +175	$^\circ\text{C}$	
T_{stg}		-40 ... +125	$^\circ\text{C}$	
V_{isol}	AC, 1 min.	4000	V	

Characteristics		$T_{case} = 25^\circ\text{C}$, unless otherwise specified			
Symbol	Conditions	min.	typ.	max.	Units
IGBT					
$V_{GE(th)}$	$V_{GE} = V_{CES}$, $I_C = 4,8\text{mA}$	5	5,8	6,5	V
I_{CES}	$V_{GE} = 0\text{V}$, $V_{CE} = V_{CES}$	$T_j = 25^\circ\text{C}$	0,15	0,45	mA
		$T_j = 150^\circ\text{C}$	0,85	0,9	V
V_{CE0}					
r_{CE}	$V_{GE} = 15\text{V}$	$T_j = 25^\circ\text{C}$	1,8	3	$\text{m}\Omega$
		$T_j = 150^\circ\text{C}$	2,7	3,8	$\text{m}\Omega$
$V_{CE(sat)}$	$I_{Cnom} = 300\text{A}$, $V_{GE} = 15\text{V}$	$T_j = 25^\circ\text{C}_{chiplev.}$	1,45	1,9	V
		$T_j = 150^\circ\text{C}_{chiplev.}$	1,7	2,1	V
C_{res}	$V_{CE} = 25$, $V_{GE} = 0\text{V}$	$f = 1\text{MHz}$	18,5		nF
C_{oes}			1,2		nF
C_{res}			0,55		nF
Q_G	$V_{GE} = -8\text{V} \dots +15\text{V}$		2400		nC
R_{Gint}	$T_j = ^\circ\text{C}$		1		Ω
$t_{d(on)}$	$R_{Gon} = 2,4\ \Omega$	$V_{CC} = 300\text{V}$ $I_C = 300\text{A}$	150		ns
t_r			48		ns
E_{on}	$R_{Goff} = 2,4\ \Omega$	$T_j = 150^\circ\text{C}$ $V_{GE} = -8\text{V}/+15\text{V}$	7,5		mJ
$t_{d(off)}$			540		ns
t_f			53		ns
E_{off}			11,5		mJ
$R_{th(j-c)}$	per IGBT			0,15	K/W

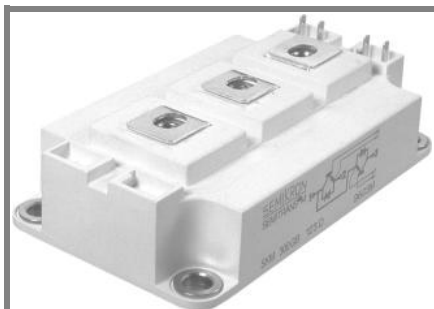

SEMITRANS® 3

Trench IGBT Modules

SKM 300GB066D

Features

- Homogeneous Si
- Trench = Trenchgate technology
- $V_{CE(sat)}$ with positive temperature coefficient
- High short circuit capability, self limiting to $6 \times I_C$

Typical Applications*

- AC inverter drives
- UPS
- Electronic welders

Remarks

- Case temperature limited to $T_C = 125^\circ\text{C}$ max, recommended $T_{op} = -40 \dots +150^\circ\text{C}$
- Product reliability results are valid for $T_j \leq 150^\circ\text{C}$
- Short circuit data: $t_p \leq 6\mu\text{s}$; $V_{GE} \leq 15\text{V}$; $T_j = 150^\circ\text{C}$; $V_{CC} \leq 360\text{V}$, use of soft R_G necessary !
- Take care of over-voltage caused by stray inductances

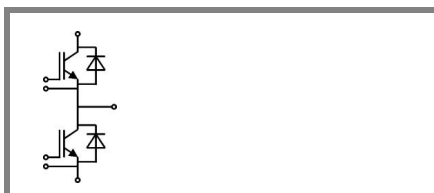

GB

Characteristics

Symbol	Conditions	min.	typ.	max.	Units
Inverse Diode					
$V_F = V_{EC}$	$I_{Fnom} = 300\text{ A}$; $V_{GE} = 0\text{ V}$ $T_j = 25^\circ\text{C}_{chiplev.}$		1,4	1,6	V
V_{F0}	$T_j = 25^\circ\text{C}$		0,95	1	V
r_F	$T_j = 25^\circ\text{C}$		1,5	2	mΩ
I_{RRM}	$I_F = 300\text{ A}$ $T_j = 150^\circ\text{C}$		340		A
Q_{rr}	$di/dt = 7000\text{ A}/\mu\text{s}$		47		μC
E_{rr}	$V_{GE} = -8\text{ V}$; $V_{CC} = 300\text{ V}$		10,5		mJ
$R_{th(j-c)D}$	per diode			0,25	K/W
Module					
L_{CE}			15	20	nH
R_{CC+EE}	res., terminal-chip $T_{case} = 25^\circ\text{C}$		0,35		mΩ
	$T_{case} = 125^\circ\text{C}$		0,5		mΩ
$R_{th(c-s)}$	per module			0,038	K/W
M_s	to heat sink M6	3		5	Nm
M_t	to terminals M6	2,5		5	Nm
w				325	g

This is an electrostatic discharge sensitive device (ESDS), international standard IEC 60747-1, Chapter IX.

* The specifications of our components may not be considered as an assurance of component characteristics. Components have to be tested for the respective application. Adjustments may be necessary. The use of SEMIKRON products in life support appliances and systems is subject to prior specification and written approval by SEMIKRON. We therefore strongly recommend prior consultation of our personal.

SKM 300GB066D

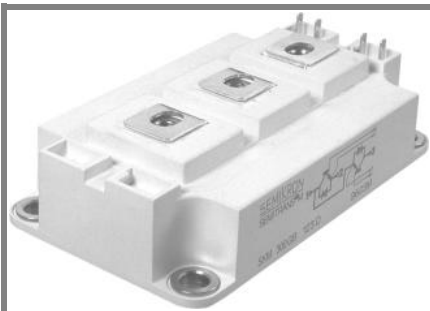

SEMITRANS® 3

Trench IGBT Modules

SKM 300GB066D

Features

- Homogeneous Si
- Trench = Trenchgate technology
- $V_{CE(sat)}$ with positive temperature coefficient
- High short circuit capability, self limiting to $6 \times I_C$

Typical Applications*

- AC inverter drives
- UPS
- Electronic welders

Remarks

- Case temperature limited to $T_C = 125^\circ\text{C}$ max, recommended $T_{op} = -40 \dots +150^\circ\text{C}$
- Product reliability results are valid for $T_j \leq 150^\circ\text{C}$
- Short circuit data: $t_p \leq 6\mu\text{s}$; $V_{GE} \leq 15\text{V}$; $T_j = 150^\circ\text{C}$; $V_{CC} \leq 360\text{V}$, use of soft R_G necessary !
- Take care of over-voltage caused by stray inductances

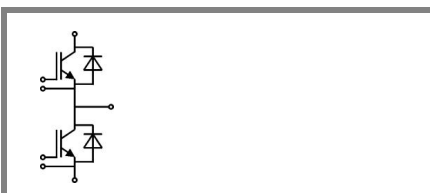

GB

Z_{th}			
Symbol	Conditions	Values	Units
$Z_{th(j-c)I}$			
$R_{\theta i}$	$i = 1$	107	mk/W
$R_{\theta i}$	$i = 2$	30	mk/W
$R_{\theta i}$	$i = 3$	11,6	mk/W
$R_{\theta i}$	$i = 4$	1,4	mk/W
$\tau_{\theta i}$	$i = 1$	0,054	s
$\tau_{\theta i}$	$i = 2$	0,0144	s
$\tau_{\theta i}$	$i = 3$	0,0007	s
$\tau_{\theta i}$	$i = 4$	0,0004	s
$Z_{th(j-c)D}$			
$R_{\theta i}$	$i = 1$	140	mk/W
$R_{\theta i}$	$i = 2$	82	mk/W
$R_{\theta i}$	$i = 3$	23,5	mk/W
$R_{\theta i}$	$i = 4$	4,5	mk/W
$\tau_{\theta i}$	$i = 1$	0,054	s
$\tau_{\theta i}$	$i = 2$	0,01	s
$\tau_{\theta i}$	$i = 3$	0,0015	s
$\tau_{\theta i}$	$i = 4$	0,0002	s

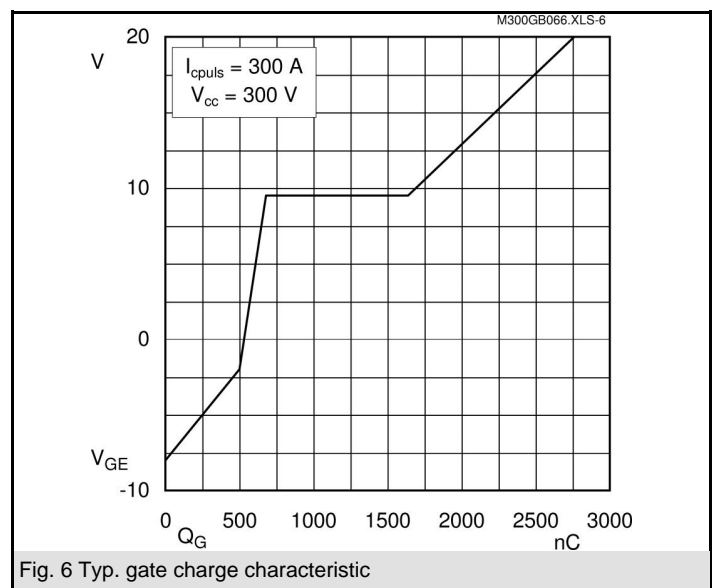
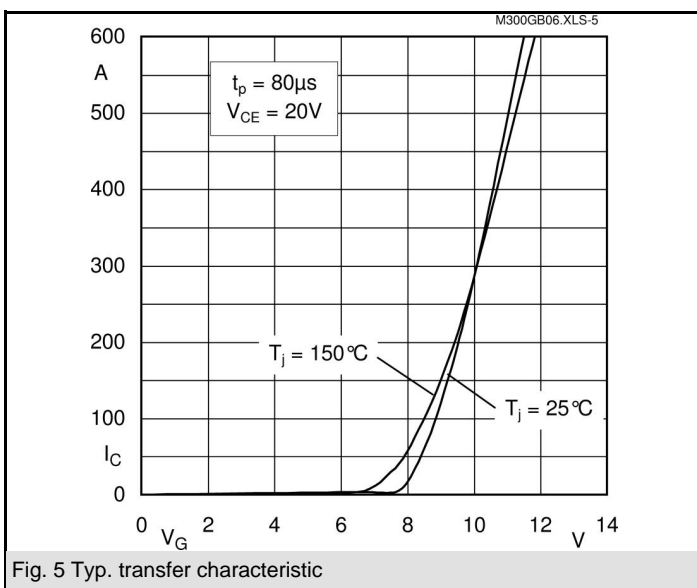
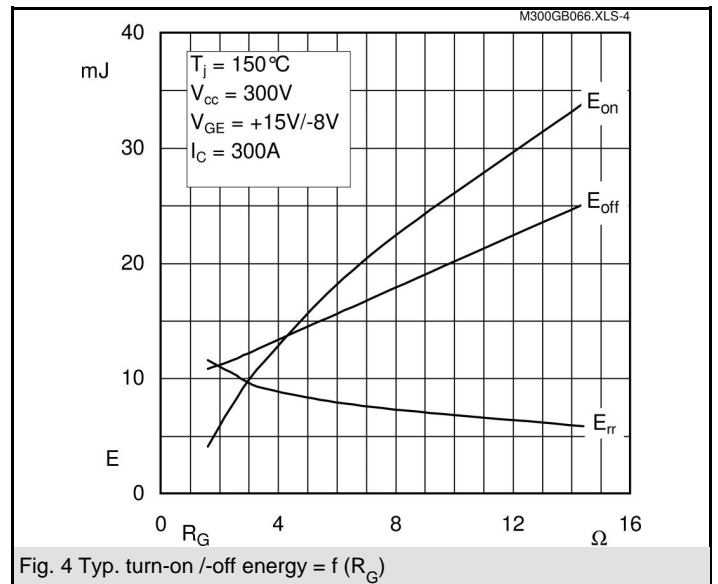
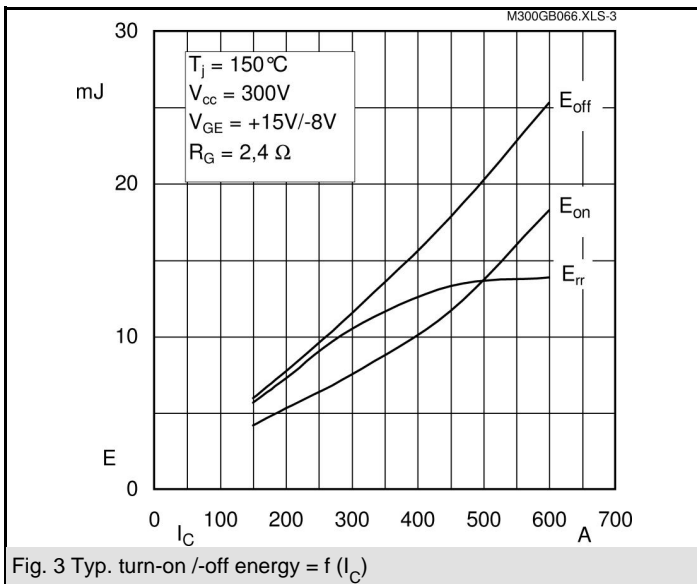
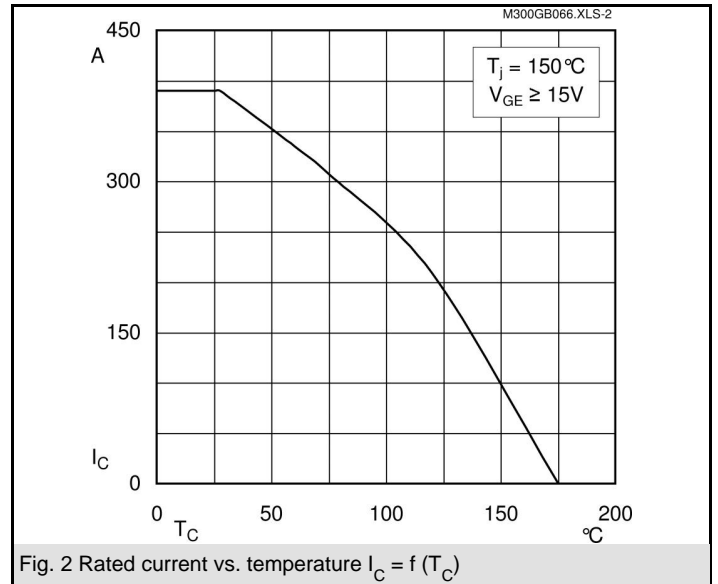
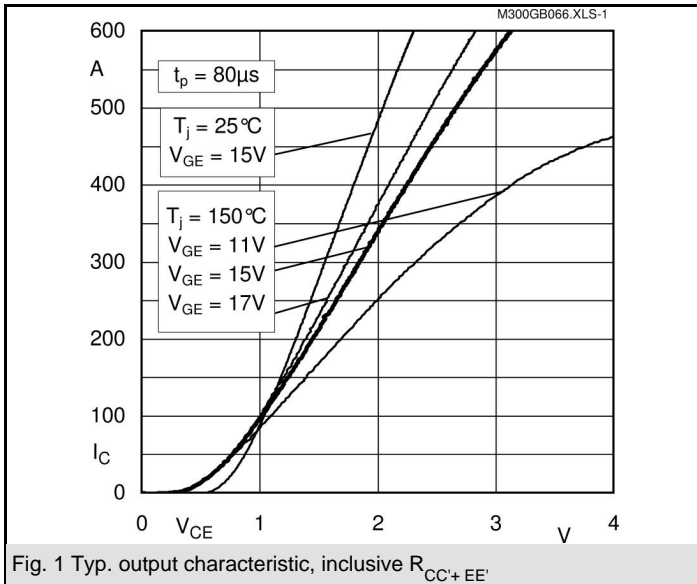

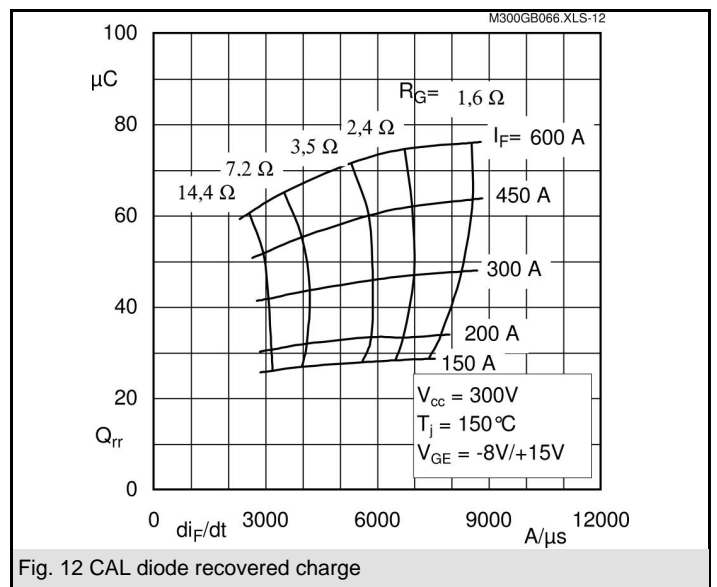
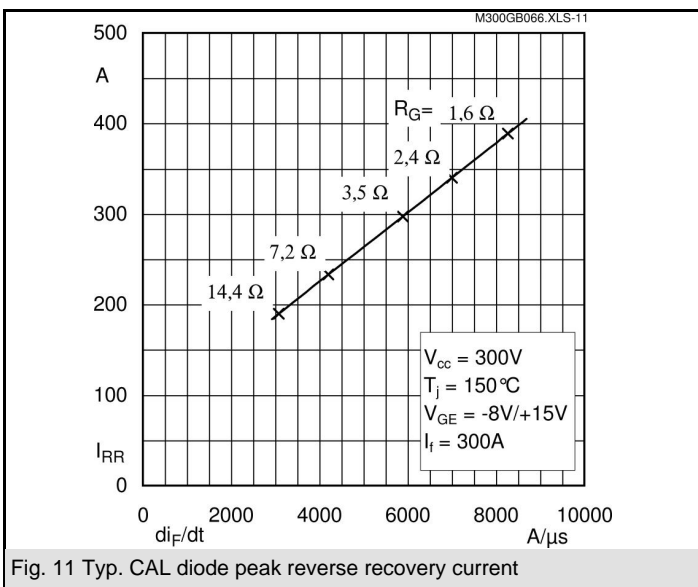
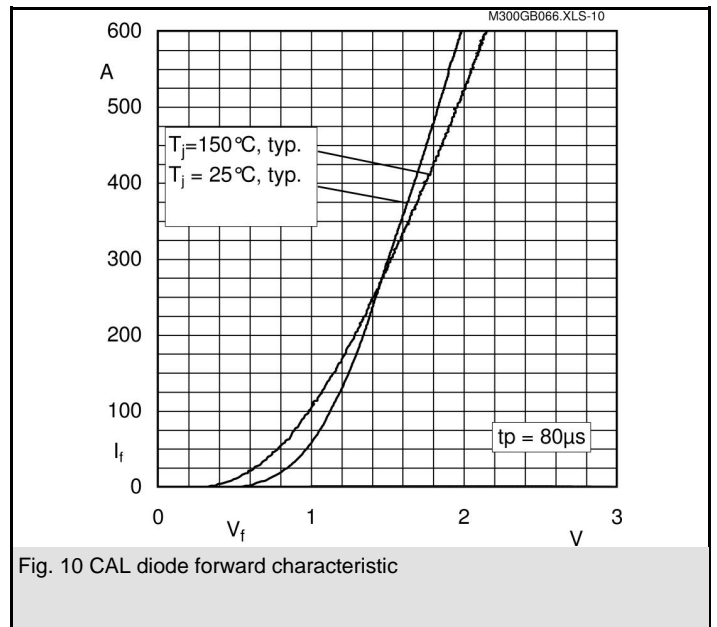
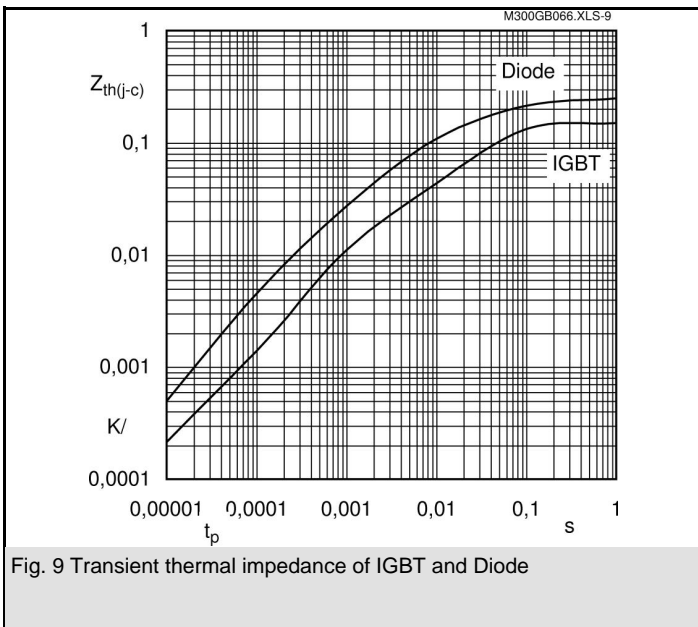
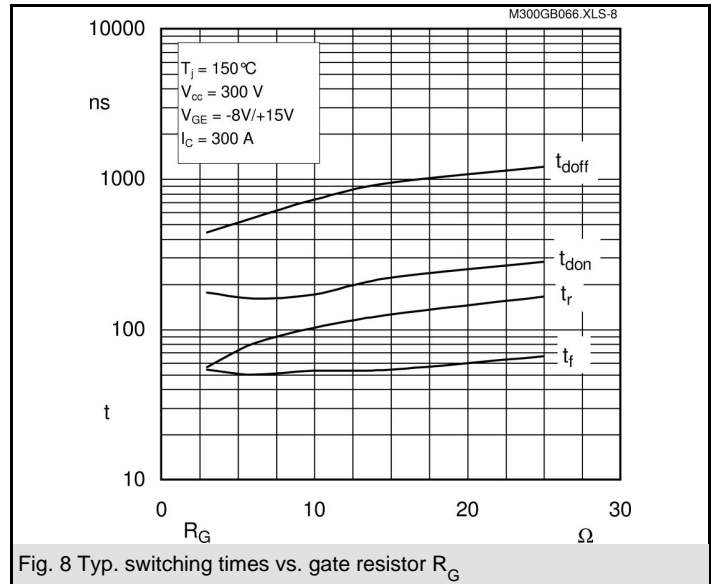
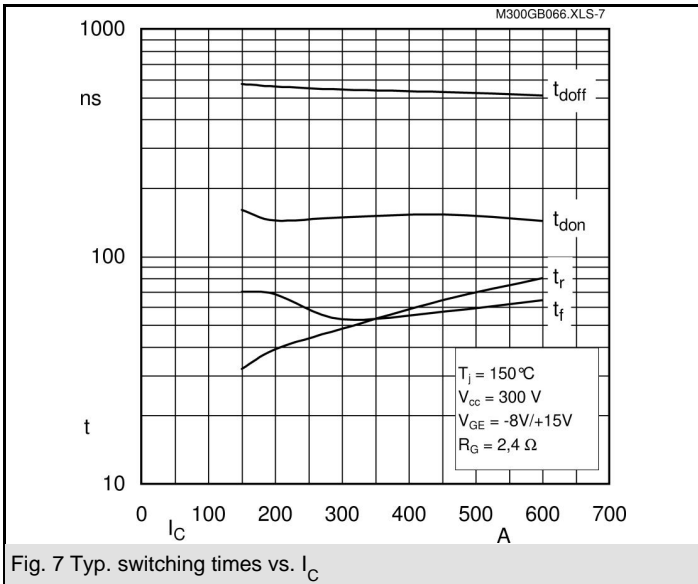

SKM 300GB066D

UL recognized, file no. E 63 532

CASED56

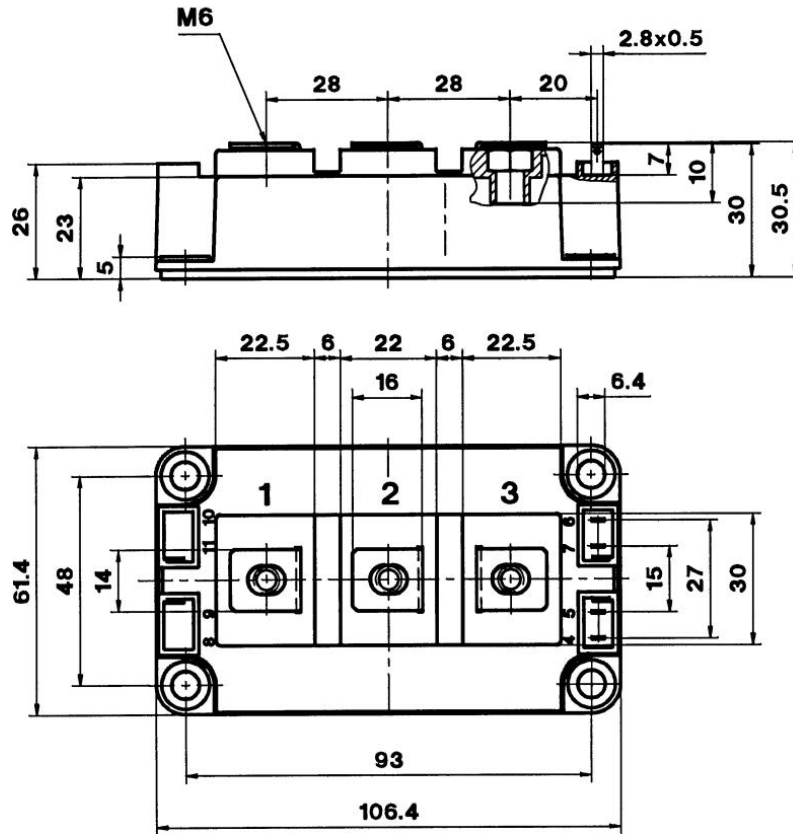

Case D 56

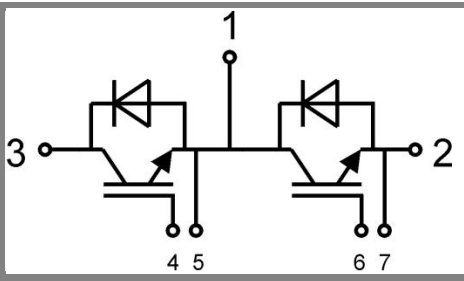

GB

Case D56