

SKKT 42, SKKT 42B, SKKH 42



SEMIPACK[®] 1

Thyristor / Diode Modules

SKKT 42

SKKT 42B

SKKH 42

Features

- Heat transfer through aluminium oxide ceramic isolated metal baseplate
- Hard soldered joints for high reliability
- UL recognized, file no. E 63 532

Typical Applications

- DC motor control (e. g. for machine tools)
- AC motor soft starters
- Temperature control (e. g. for ovens, chemical processes)
- Professional light dimming (studios, theaters)

1) See the assembly instructions

| V_{RSM} V | V_{RRM}, V_{DRM} V | $I_{TRMS} = 75$ A (maximum value for continuous operation) | | |
|----------------|-------------------------|--|-------------|-------------|
| | | $I_{TAV} = 40$ A (sin. 180; $T_c = 85$ °C) | | |
| 900 | 800 | SKKT 42/08E | SKKT 42B08E | SKKH 42/08E |
| 1300 | 1200 | SKKT 42/12E | SKKT 42B12E | SKKH 42/12E |
| 1500 | 1400 | SKKT 42/14E | SKKT 42B14E | SKKH 42/14E |
| 1700 | 1600 | SKKT 42/16E | SKKT 42B16E | SKKH 42/16E |
| 1900 | 1800 | SKKT 42/18E | SKKT 42B18E | SKKH 42/18E |

| Symbol | Conditions | Values | Units |
|------------------|---|------------------------|------------------|
| I_{TAV} | sin. 180; $T_c = 85$ (100) °C | 40 (28) | A |
| I_D | P3/180; $T_a = 45$ °C; B2 / B6 | 50 / 60 | A |
| | P3/180F; $T_a = 35$ °C; B2 / B6 | 85 / 110 | A |
| I_{RMS} | P3/180F; $T_a = 35$ °C; W1 / W3 | 110 / 3 * 85 | A |
| I_{TSM} | $T_{vj} = 25$ °C; 10 ms | 1000 | A |
| | $T_{vj} = 125$ °C; 10 ms | 850 | A |
| i^2t | $T_{vj} = 25$ °C; 8,3 ... 10 ms | 5000 | A ² s |
| | $T_{vj} = 125$ °C; 8,3 ... 10 ms | 3600 | A ² s |
| V_T | $T_{vj} = 25$ °C; $I_T = 200$ A | max. 1,95 | V |
| $V_{T(TO)}$ | $T_{vj} = 125$ °C | 1 | V |
| r_T | $T_{vj} = 125$ °C | 4,5 | mΩ |
| $I_{DD}; I_{RD}$ | $T_{vj} = 125$ °C; $V_{RD} = V_{RRM}; V_{DD} = V_{DRM}$ | max. 15 | mA |
| t_{gd} | $T_{vj} = 25$ °C; $I_G = 1$ A; $di_G/dt = 1$ A/μs | 1 | μs |
| t_{gr} | $V_D = 0,67 * V_{DRM}$ | 2 | μs |
| $(di/dt)_{cr}$ | $T_{vj} = 125$ °C | max. 150 | A/μs |
| $(dv/dt)_{cr}$ | $T_{vj} = 125$ °C | max. 1000 | V/μs |
| t_q | $T_{vj} = 125$ °C | 80 | μs |
| I_H | $T_{vj} = 25$ °C; typ. / max. | 150 / 250 | mA |
| I_L | $T_{vj} = 25$ °C; $R_G = 33$ Ω; typ. / max. | 300 / 600 | mA |
| V_{GT} | $T_{vj} = 25$ °C; d.c. | min. 3 | V |
| I_{GT} | $T_{vj} = 25$ °C; d.c. | min. 150 | mA |
| V_{GD} | $T_{vj} = 125$ °C; d.c. | max. 0,25 | V |
| I_{GD} | $T_{vj} = 125$ °C; d.c. | max. 6 | mA |
| $R_{th(j-c)}$ | cont.; per thyristor / per module | 0,65 / 0,33 | K/W |
| $R_{th(j-c)}$ | sin. 180; per thyristor / per module | 0,69 / 0,35 | K/W |
| $R_{th(j-c)}$ | rec. 120; per thyristor / per module | 0,73 / 0,37 | K/W |
| $R_{th(c-s)}$ | per thyristor / per module | 0,2 / 0,1 | K/W |
| T_{vj} | | - 40 ... + 125 | °C |
| T_{stg} | | - 40 ... + 125 | °C |
| V_{isol} | a. c. 50 Hz; r.m.s.; 1 s / 1 min. | 3600 / 3000 | V~ |
| M_s | to heatsink | 5 ± 15 % ¹⁾ | Nm |
| M_t | to terminals | 3 ± 15 % | Nm |
| a | | 5 * 9,81 | m/s ² |
| m | approx. | 95 | g |
| Case | SKKT | A 46 | |
| | SKKT ...B | A 48 | |
| | SKKH | A 47 | |



SKKT

SKKH

SKKT 42, SKKT 42B, SKKH 42

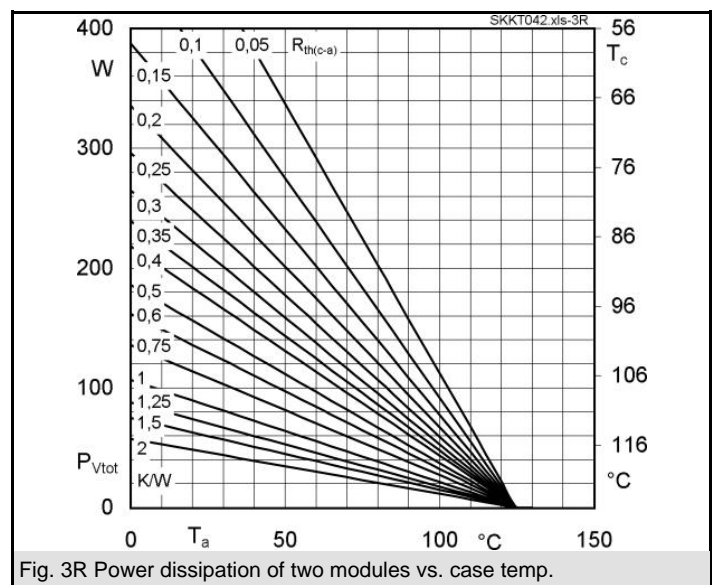
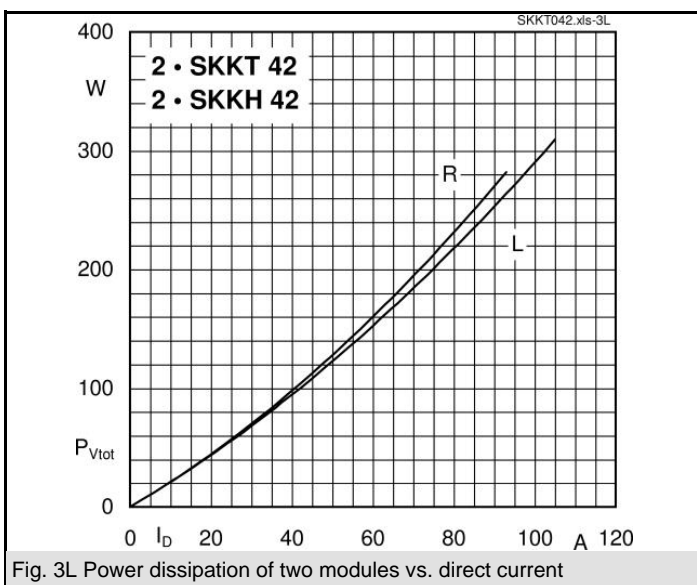
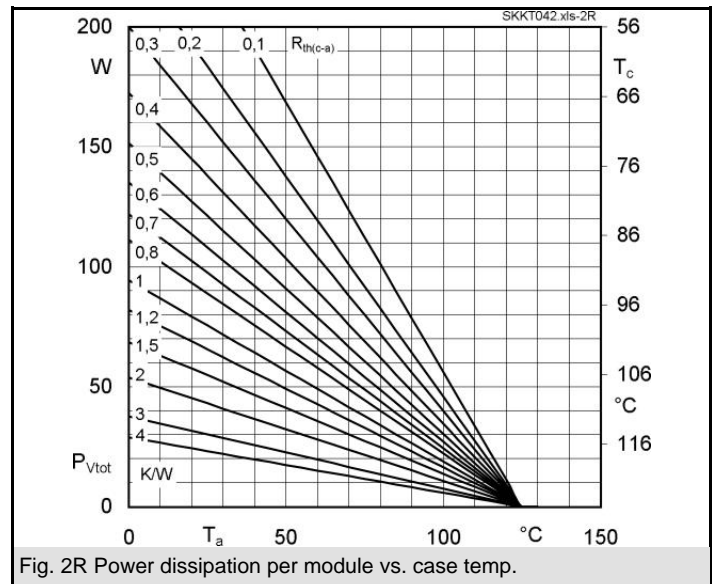
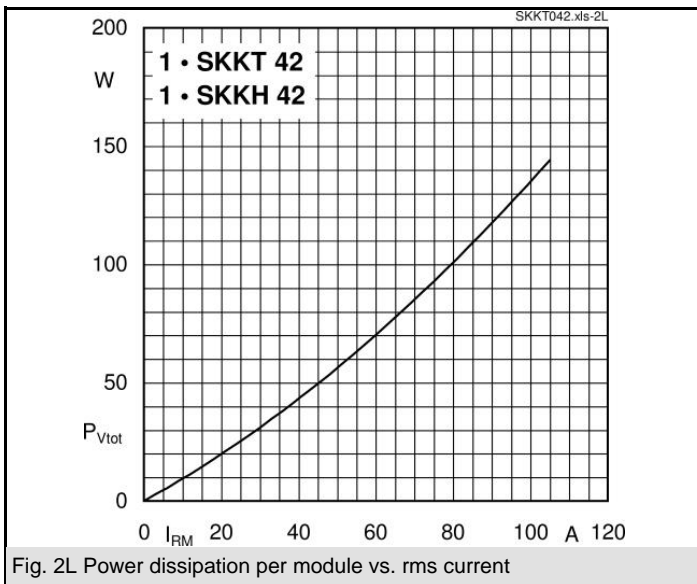
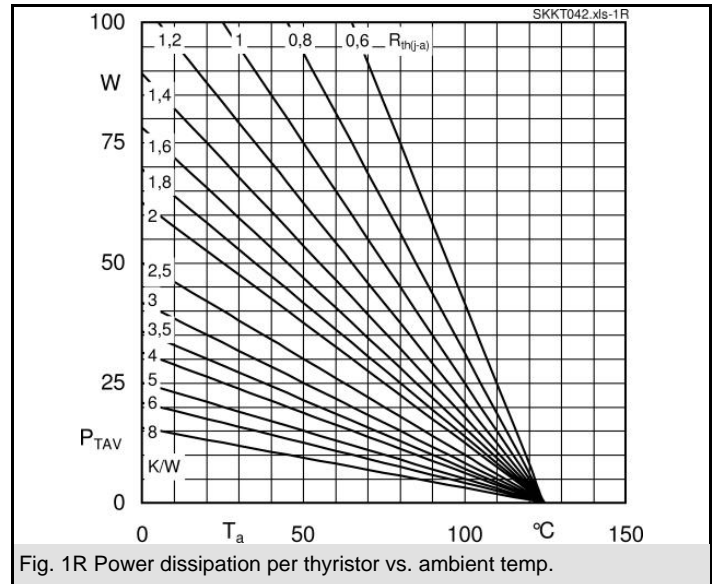
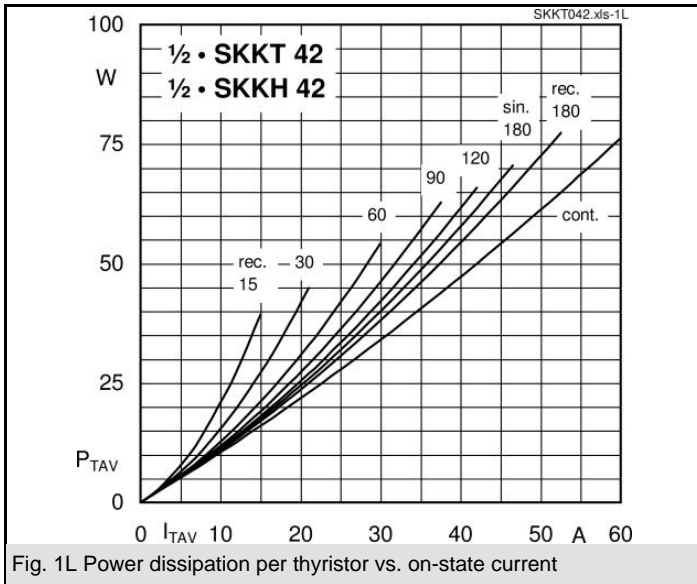

SKKT 42, SKKT 42B, SKKH 42

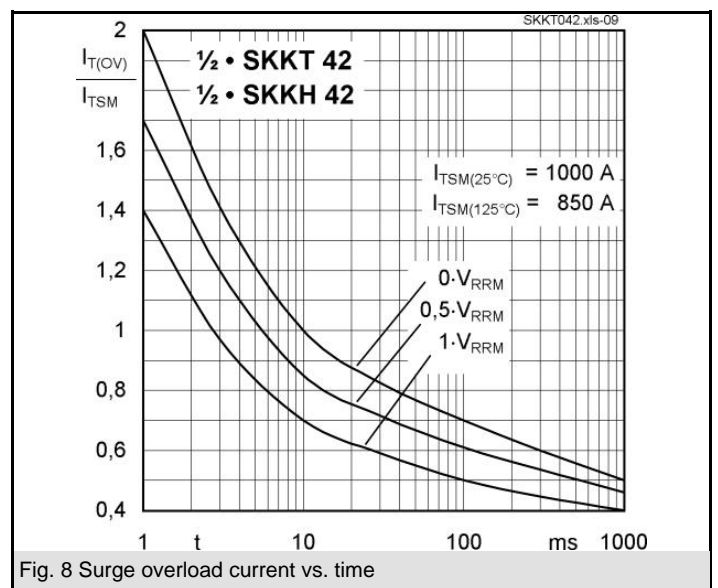
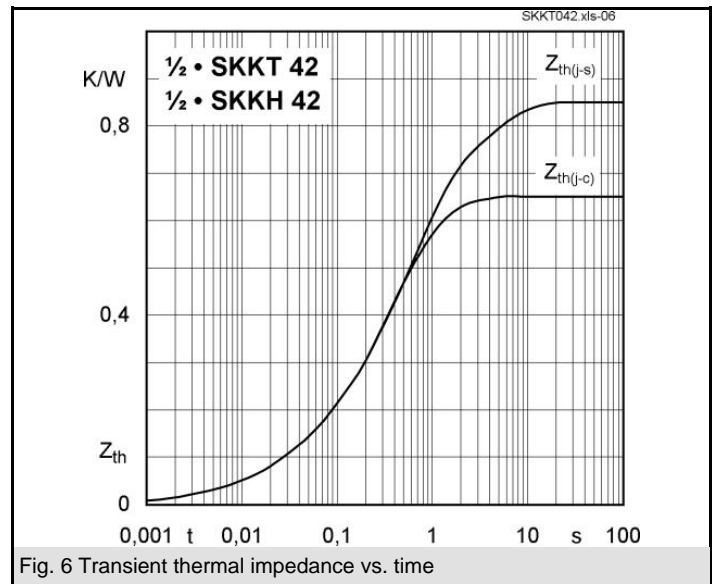
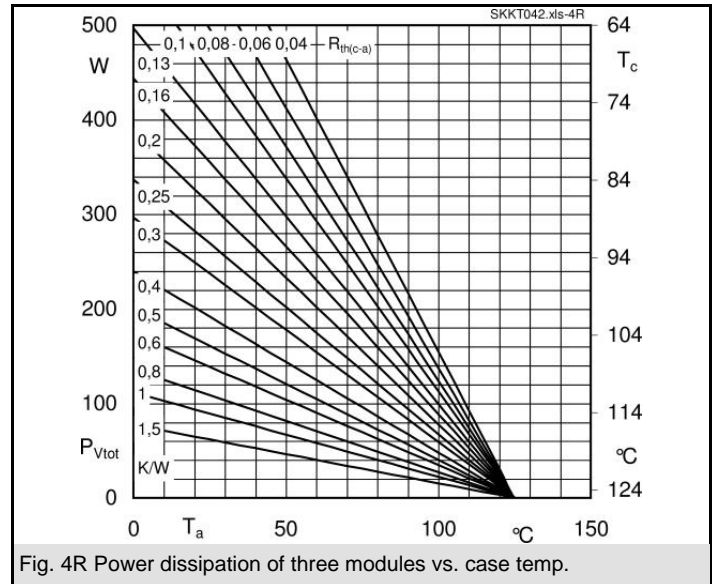

SKKT 42, SKKT 42B, SKKH 42

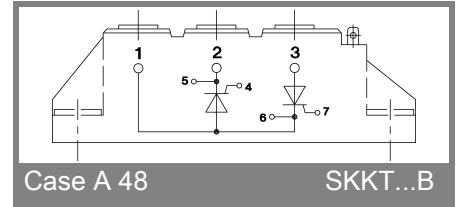
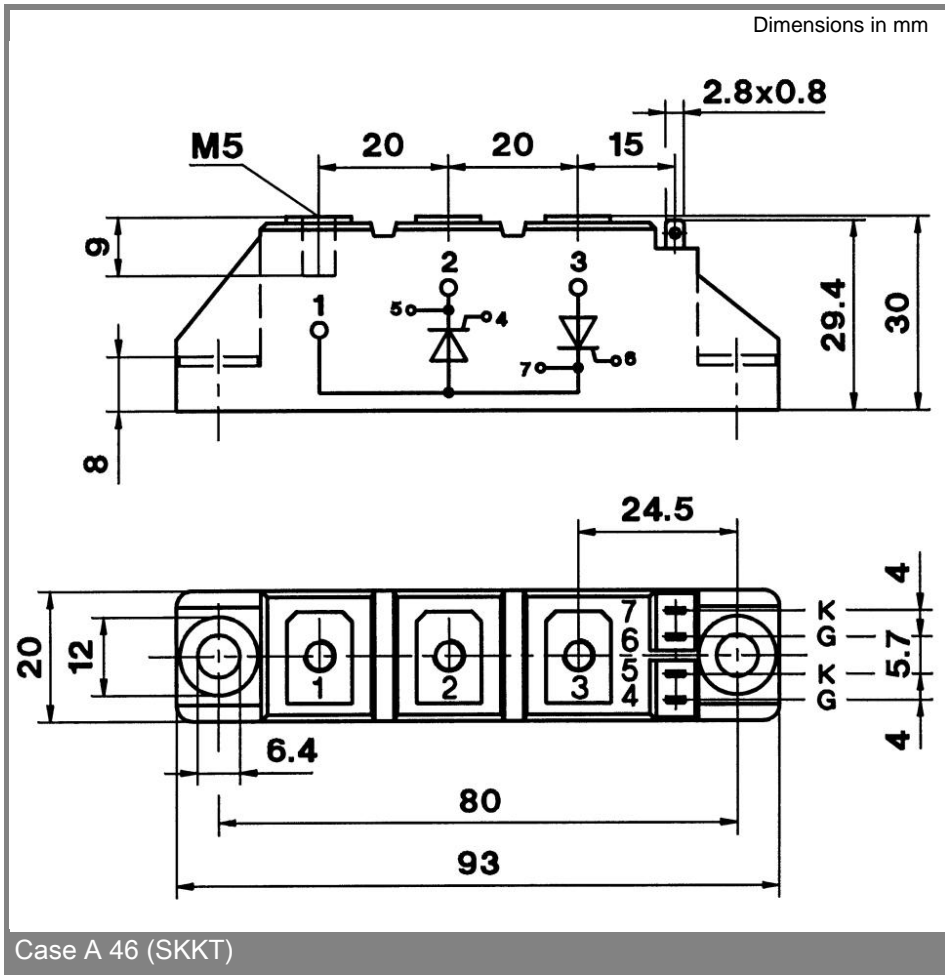

This technical information specifies semiconductor devices but promises no characteristics. No warranty or guarantee expressed or implied is made regarding delivery, performance or suitability.