

SKKT 92, SKKH 92, SKKT 92B



SEMIPACK[®] 1

Thyristor / Diode Modules

SKKT 92

SKKT 92B

SKKH 92

Features

- Heat transfer through aluminium oxide ceramic isolated metal baseplate
- Hard soldered joints for high reliability
- UL recognized, file no. E 63 532

Typical Applications

- DC motor control (e. g. for machine tools)
- AC motor soft starters
- Temperature control (e. g. for ovens, chemical processes)
- Professional light dimming (studios, theaters)

1) See the assembly instructions

| V_{RSM} V | V_{RRM}, V_{DRM} V | $I_{TRMS} = 150$ A (maximum value for continuous operation) | | |
|----------------|-------------------------|---|-------------|-------------|
| | | $I_{TAV} = 95$ A (sin. 180; $T_c = 85$ °C) | | |
| 900 | 800 | SKKT 92/08E | SKKT 92B08E | SKKH 92/08E |
| 1300 | 1200 | SKKT 92/12E | SKKT 92B12E | SKKH 92/12E |
| 1500 | 1400 | SKKT 92/14E | SKKT 92B14E | SKKH 92/14E |
| 1700 | 1600 | SKKT 92/16E | SKKT 92B16E | SKKH 92/16E |
| 1900 | 1800 | SKKT 92/18E | SKKT 92B18E | SKKH 92/18E |

| Symbol | Conditions | Values | Units |
|------------------|---|------------------------|------------------|
| I_{TAV} | sin. 180; $T_c = 85$ (100) °C | 95 (68) | A |
| I_D | P3/180; $T_a = 45$ °C; B2 / B6 | 70 / 85 | A |
| | P3/180F; $T_a = 35$ °C; B2 / B6 | 140 / 175 | A |
| I_{RMS} | P3/180F; $T_a = 35$ °C; W1 / W3 | 190 / 3 * 135 | A |
| I_{TSM} | $T_{vj} = 25$ °C; 10 ms | 2000 | A |
| | $T_{vj} = 125$ °C; 10 ms | 1750 | A |
| i^2t | $T_{vj} = 25$ °C; 8,3 ... 10 ms | 20000 | A ² s |
| | $T_{vj} = 125$ °C; 8,3 ... 10 ms | 15000 | A ² s |
| V_T | $T_{vj} = 25$ °C; $I_T = 300$ A | max. 1,65 | V |
| $V_{T(TO)}$ | $T_{vj} = 125$ °C | 0,9 | V |
| r_T | $T_{vj} = 125$ °C | 2 | mΩ |
| $I_{DD}; I_{RD}$ | $T_{vj} = 125$ °C; $V_{RD} = V_{RRM}; V_{DD} = V_{DRM}$ | max. 20 | mA |
| t_{gd} | $T_{vj} = 25$ °C; $I_G = 1$ A; $di_G/dt = 1$ A/μs | 1 | μs |
| t_{gr} | $V_D = 0,67 * V_{DRM}$ | 2 | μs |
| $(di/dt)_{cr}$ | $T_{vj} = 125$ °C | max. 150 | A/μs |
| $(dv/dt)_{cr}$ | $T_{vj} = 125$ °C | max. 1000 | V/μs |
| t_q | $T_{vj} = 125$ °C | 100 | μs |
| I_H | $T_{vj} = 25$ °C; typ. / max. | 150 / 250 | mA |
| I_L | $T_{vj} = 25$ °C; $R_G = 33$ Ω; typ. / max. | 300 / 600 | mA |
| V_{GT} | $T_{vj} = 25$ °C; d.c. | min. 3 | V |
| I_{GT} | $T_{vj} = 25$ °C; d.c. | min. 150 | mA |
| V_{GD} | $T_{vj} = 125$ °C; d.c. | max. 0,25 | V |
| I_{GD} | $T_{vj} = 125$ °C; d.c. | max. 6 | mA |
| $R_{th(j-c)}$ | cont.; per thyristor / per module | 0,28 / 0,14 | K/W |
| $R_{th(j-c)}$ | sin. 180; per thyristor / per module | 0,3 / 0,15 | K/W |
| $R_{th(j-c)}$ | rec. 120; per thyristor / per module | 0,32 / 0,16 | K/W |
| $R_{th(c-s)}$ | per thyristor / per module | 0,2 / 0,1 | K/W |
| T_{vj} | | - 40 ... + 125 | °C |
| T_{stg} | | - 40 ... + 125 | °C |
| V_{isol} | a. c. 50 Hz; r.m.s.; 1 s / 1 min. | 3600 / 3000 | V~ |
| M_s | to heatsink | 5 ± 15 % ¹⁾ | Nm |
| M_t | to terminals | 3 ± 15 % | Nm |
| a | | 5 * 9,81 | m/s ² |
| m | approx. | 95 | g |
| Case | SKKT | A 46 | |
| | SKKT ...B | A 48 | |
| | SKKH | A 47 | |



SKKT

SKKH

SKKT 92, SKKH 92, SKKT 92B

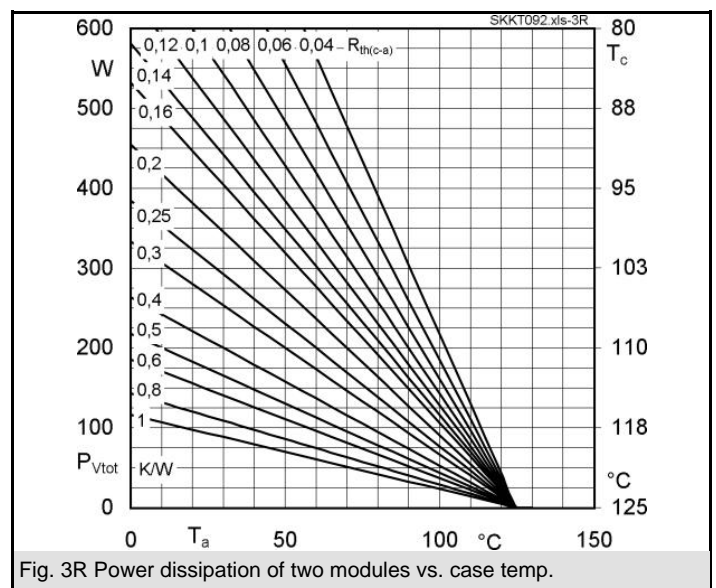
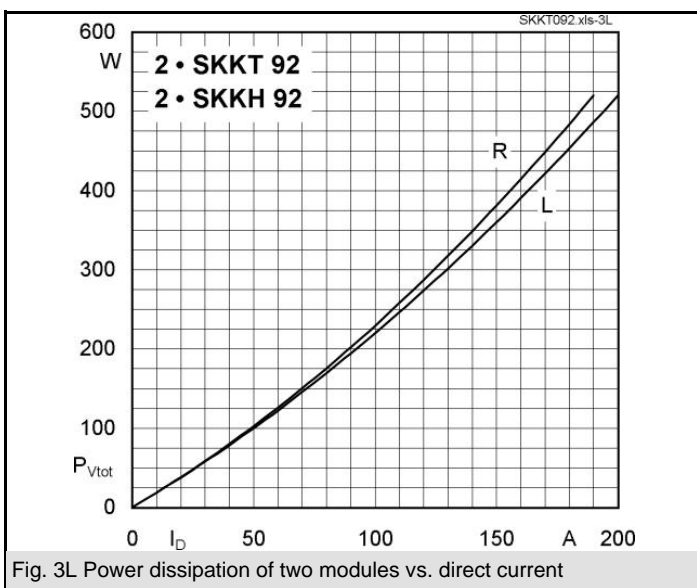
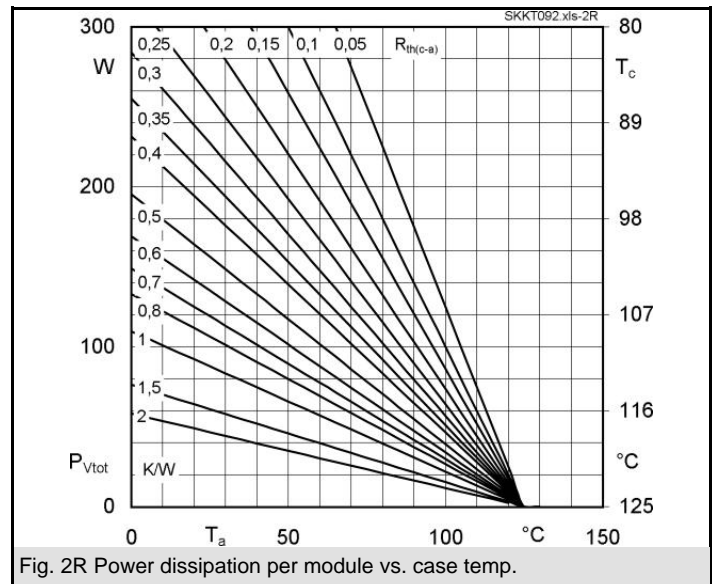
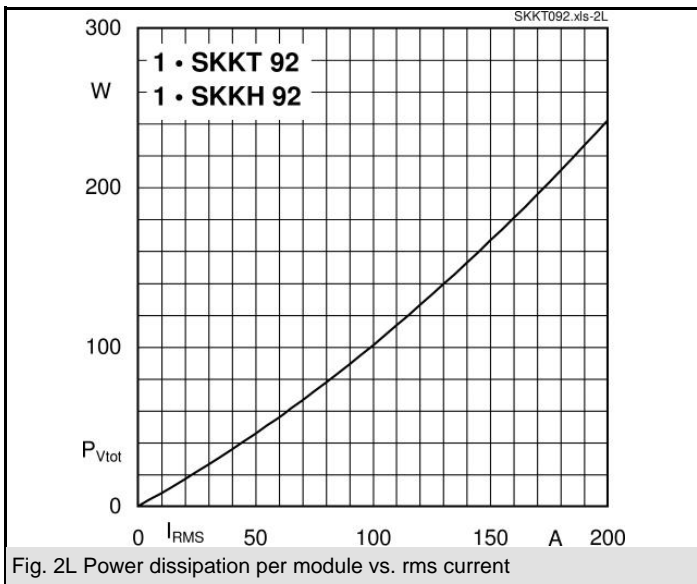
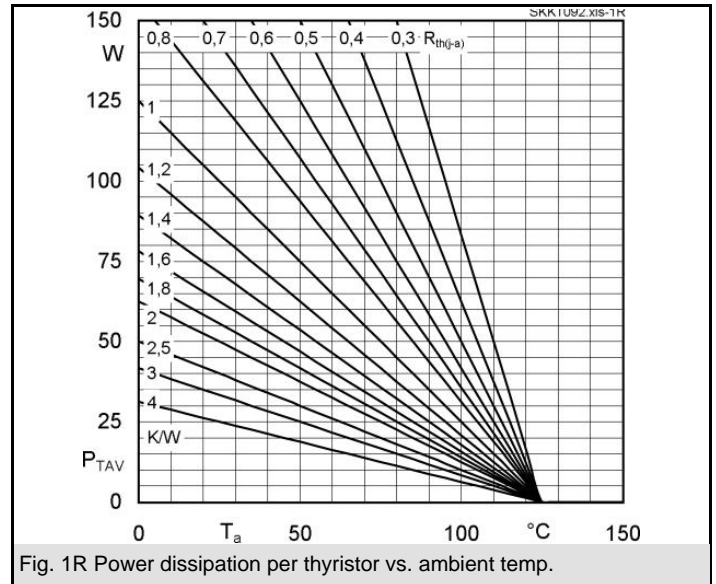
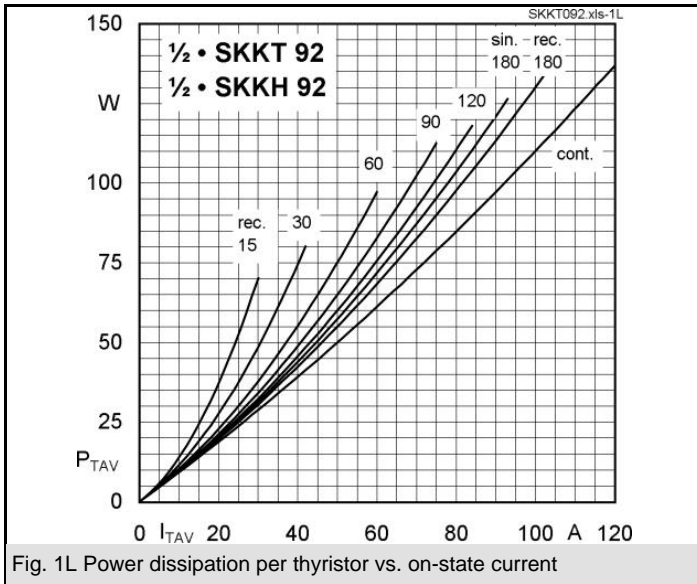

SKKT 92, SKKH 92, SKKT 92B

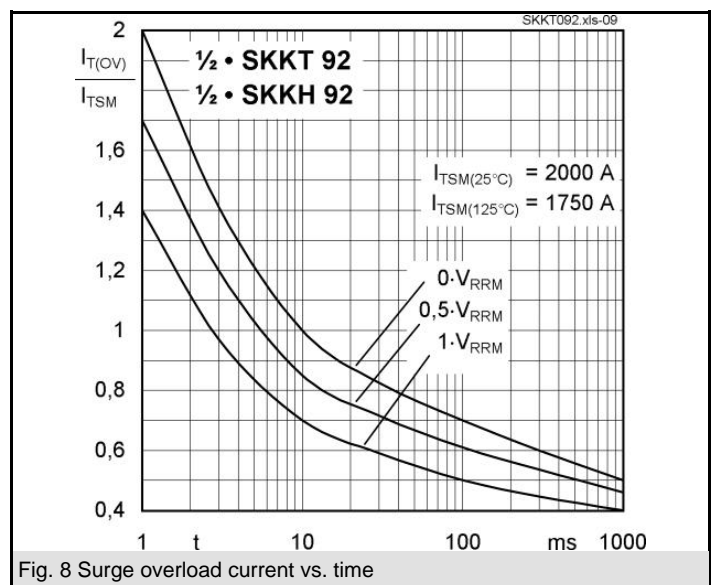
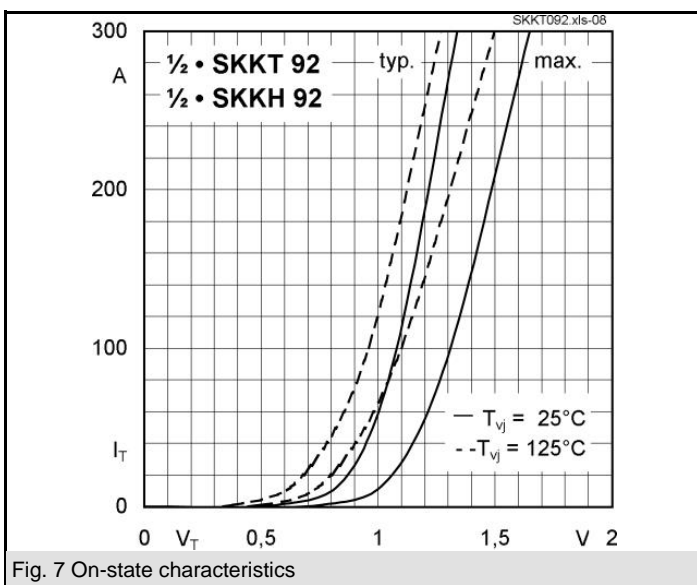

SKKT 92, SKKH 92, SKKT 92B

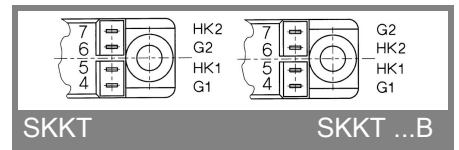
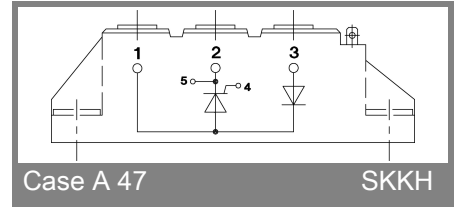
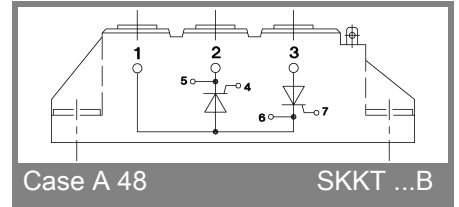
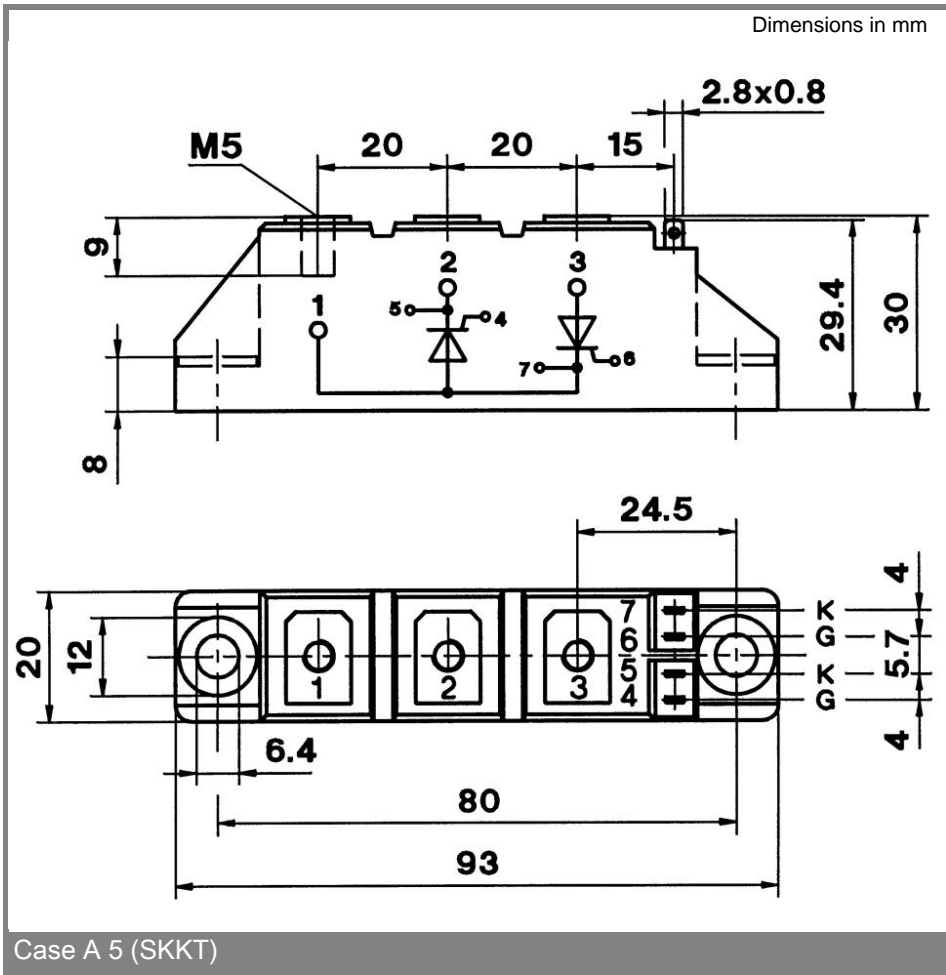

This technical information specifies semiconductor devices but promises no characteristics. No warranty or guarantee expressed or implied is made regarding delivery, performance or suitability.