

SKKT 430, SKKH 430



SEMIPACK® 5

Thyristor / Diode Modules

SKKT 430

SKKH 430

Features

- Heat transfer through aluminium nitride ceramic isolated metal baseplate
- Precious metal pressure contacts for high reliability
- UL recognized, file no. E 63 532

Typical Applications

- AC motor softstarters
- Input converters for AC inverter drives
- DC motor control (e. g. for machine tools)
- Temperature control (e. g. for ovens, chemical processes)
- Professional light dimming (studios, theaters)

- 1) See the assembly instructions
- 2) The screws must be lubricated

V_{RSM} V	V_{RRM}, V_{DRM} V	$I_{TRMS} = 700$ A (maximum value for continuous operation) $I_{TAV} = 430$ A (sin. 180; $T_c = 86$ °C)	
1700	1600	SKKT 430/16E	SKKH 430/16E
2000	2000	SKKT 430/20EH4	SKKH 430/20EH4
2200	2200	SKKT 430/22EH4	SKKH 430/22EH4

Symbol	Conditions	Values	Units
I_{TAV}	sin. 180; $T_c = 85$ (100) °C	440 (305)	A
I_D	P16/300F; $T_a = 35$ °C; B6	820	A
I_{RMS}	P16/300F; $T_a = 35$ °C; W3C	3 * 630	A
I_{TSM}	$T_{vj} = 25$ °C; 10 ms	15000	A
	$T_{vj} = 125$ °C; 10 ms	13000	A
i^2t	$T_{vj} = 25$ °C; 8,3 ... 10 ms	1125000	A ² s
	$T_{vj} = 125$ °C; 8,3 ... 10 ms	845000	A ² s
V_T	$T_{vj} = 25$ °C; $I_T = 1700$ A	max. 1,65	V
$V_{T(TO)}$	$T_{vj} = 125$ °C	max. 0,95	V
r_T	$T_{vj} = 125$ °C	max. 0,35	mΩ
$I_{DD}; I_{RD}$	$T_{vj} = 125$ °C; $V_{RD} = V_{RRM}; V_{DD} = V_{DRM}$	max. 100	mA
t_{gd}	$T_{vj} = 25$ °C; $I_G = 1$ A; $di_G/dt = 1$ A/μs	1	μs
t_{gr}	$V_D = 0,67 * V_{DRM}$	2	μs
$(di/dt)_{cr}$	$T_{vj} = 125$ °C	max. 200	A/μs
$(dv/dt)_{cr}$	$T_{vj} = 125$ °C	max. 1000	V/μs
t_q	$T_{vj} = 125$ °C	100 ... 200	μs
I_H	$T_{vj} = 25$ °C; typ. / max.	150 / 500	mA
I_L	$T_{vj} = 25$ °C; $R_G = 33$ Ω; typ. / max.	300 / 2000	mA
V_{GT}	$T_{vj} = 25$ °C; d.c.	min. 3	V
I_{GT}	$T_{vj} = 25$ °C; d.c.	min. 200	mA
V_{GD}	$T_{vj} = 130$ °C; d.c.	max. 0,25	V
I_{GD}	$T_{vj} = 130$ °C; d.c.	max. 10	mA
$R_{th(j-c)}$	cont.; per thyristor / per module	0,065 / 0,032	K/W
$R_{th(j-c)}$	sin. 180; per thyristor / per module	0,068 / 0,034	K/W
$R_{th(j-c)}$	rec. 120; per thyristors / per module	0,073 / 0,036	K/W
$R_{th(c-s)}$	per thyristor / per module	0,02 / 0,01	K/W
T_{vj}		- 40 ... + 125	°C
T_{stg}		- 40 ... + 125	°C
V_{isol}	a. c. 50 Hz; r.m.s.; 1 s / 1 min.	3600 / 3000	V~
V_{isol}	a. c. 50 Hz; r.m.s.; 1 s / 1 min. for SKK ...H4	4800 / 4000	V~
M_s	to heatsink	5 ± 15 % ¹⁾	Nm
M_t	to terminal	12 ± 15 % ²⁾	Nm
a		5 * 9,81	m/s ²
m	approx.	1420	g
Case	SKKT	A 60 a	
	SKKH	A 66 a	

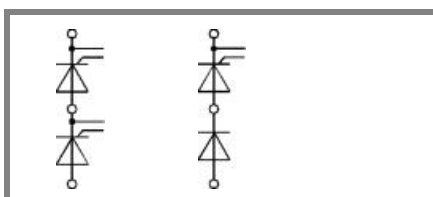

SKKT

SKKH

SKKT 430, SKKH 430

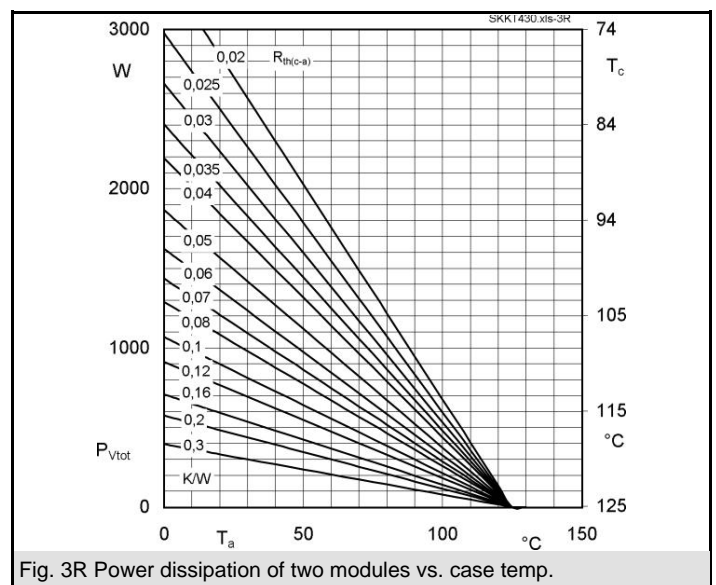
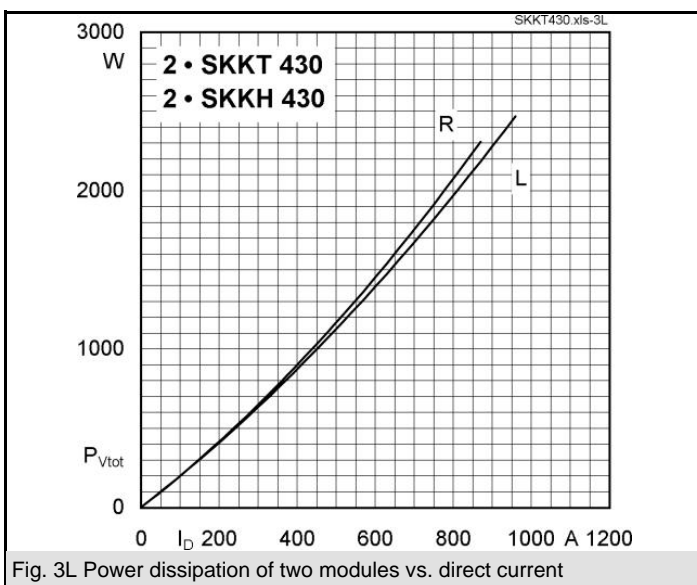
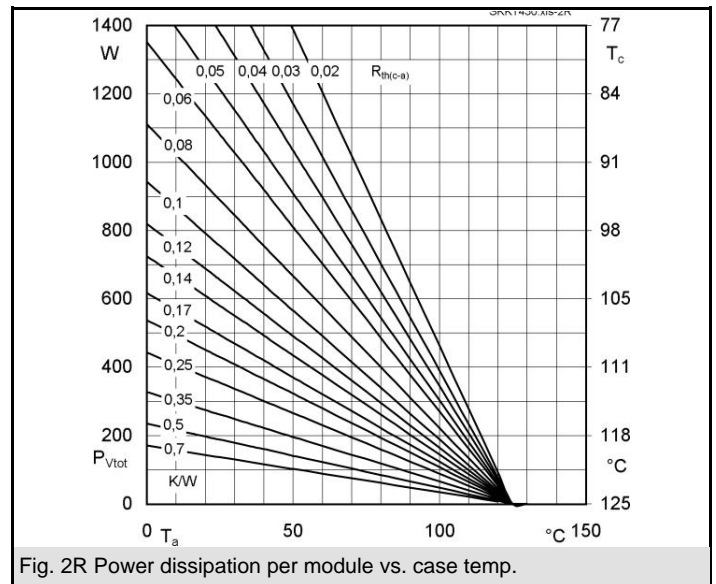
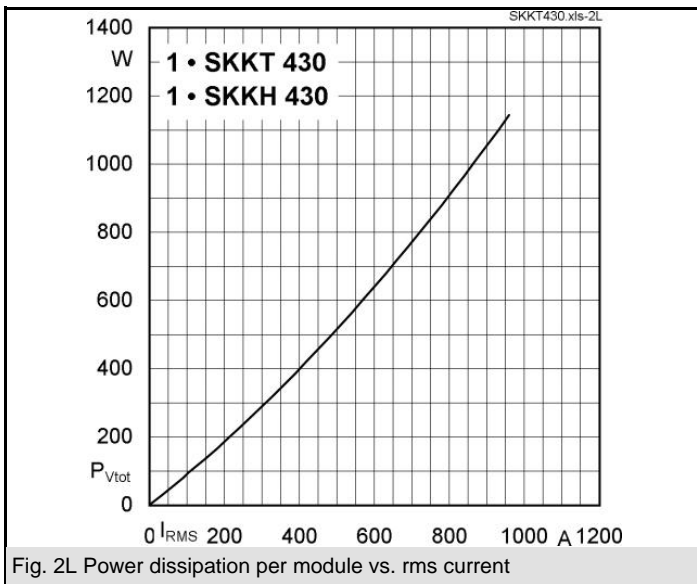
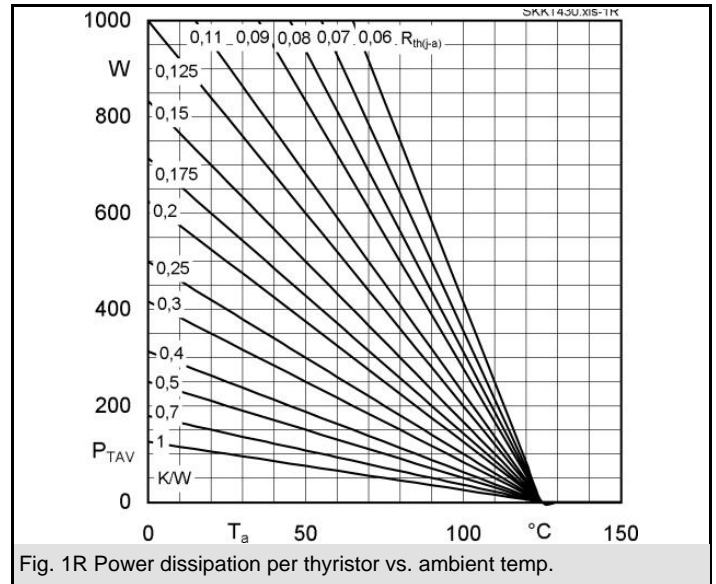
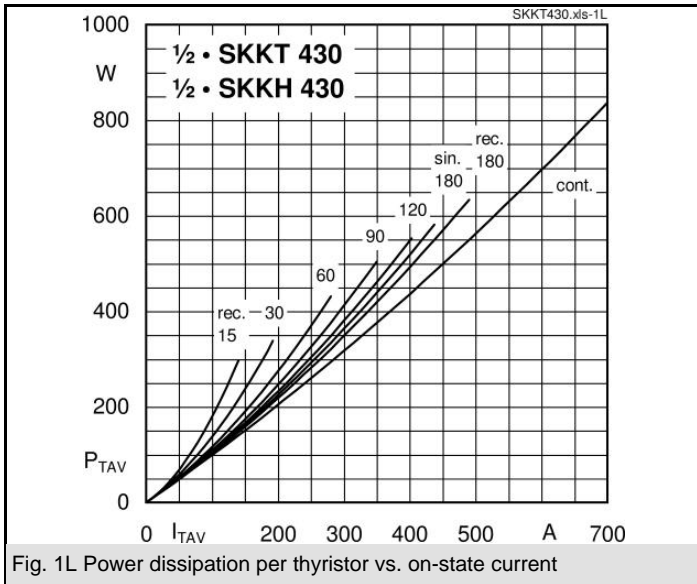

SKKT 430, SKKH 430

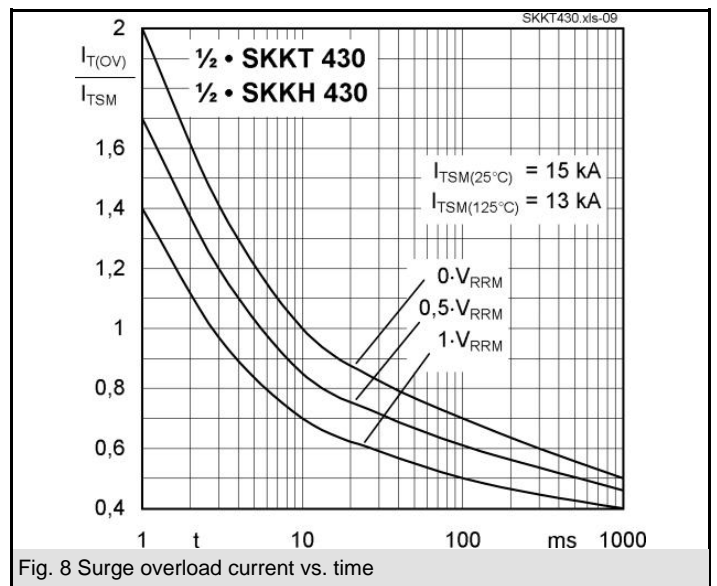
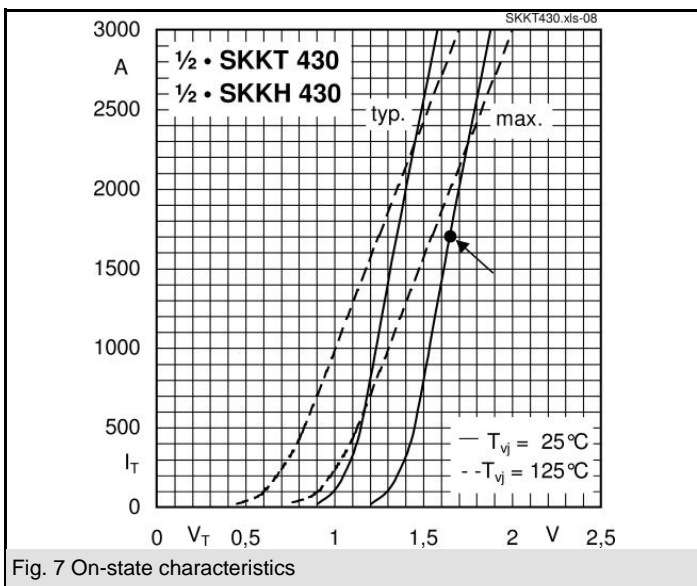
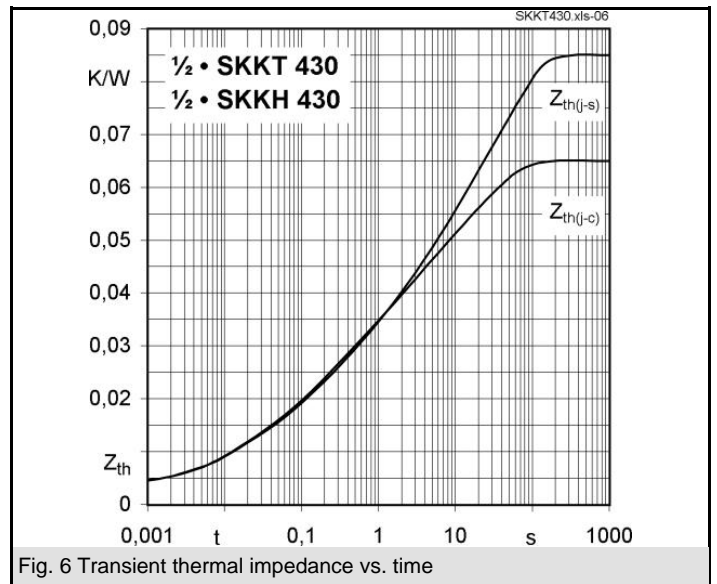
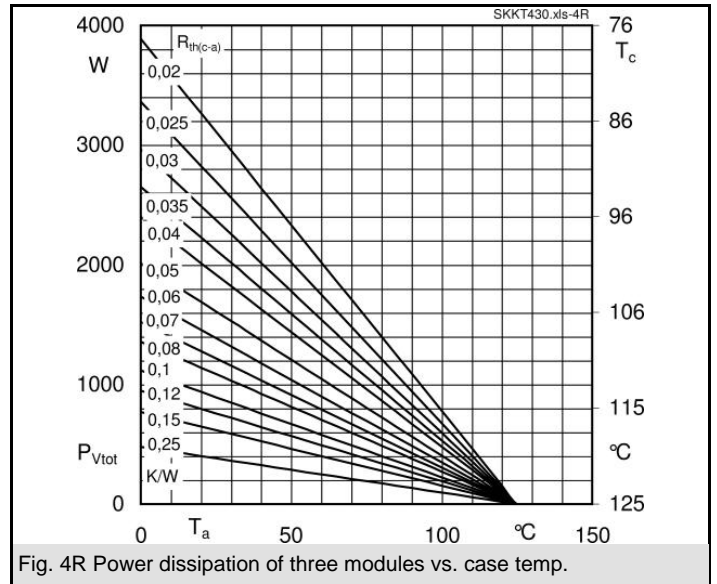
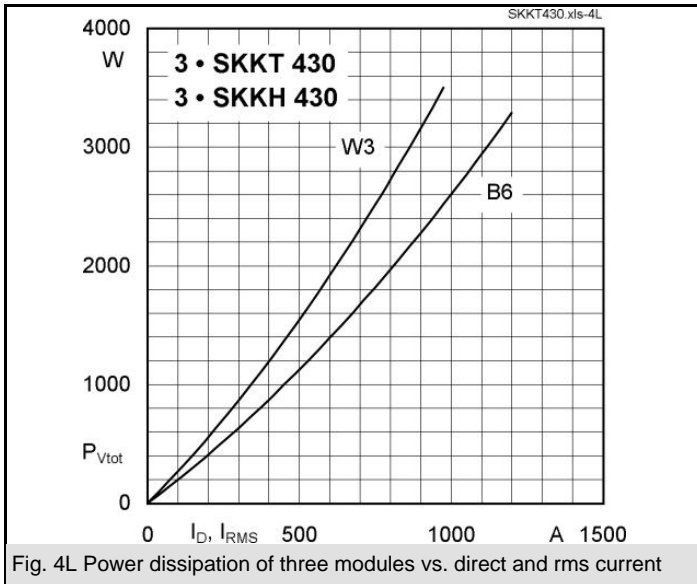

SKKT 430, SKKH 430

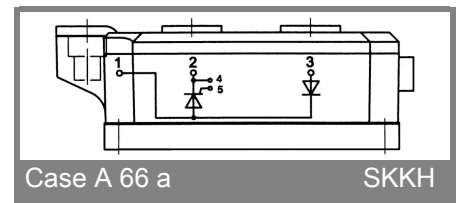
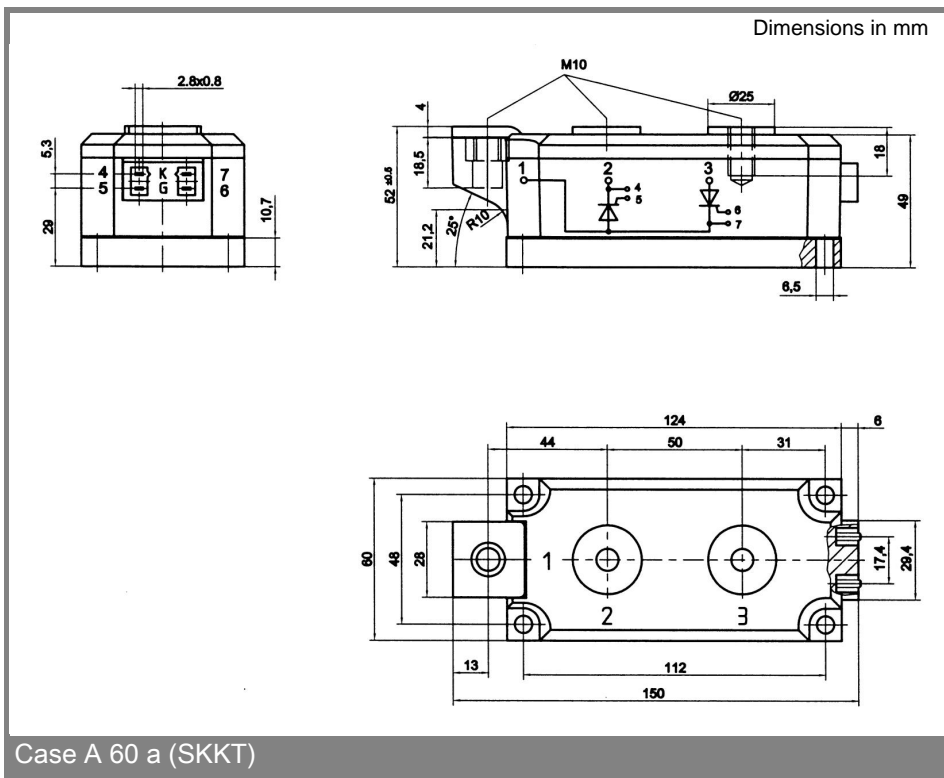
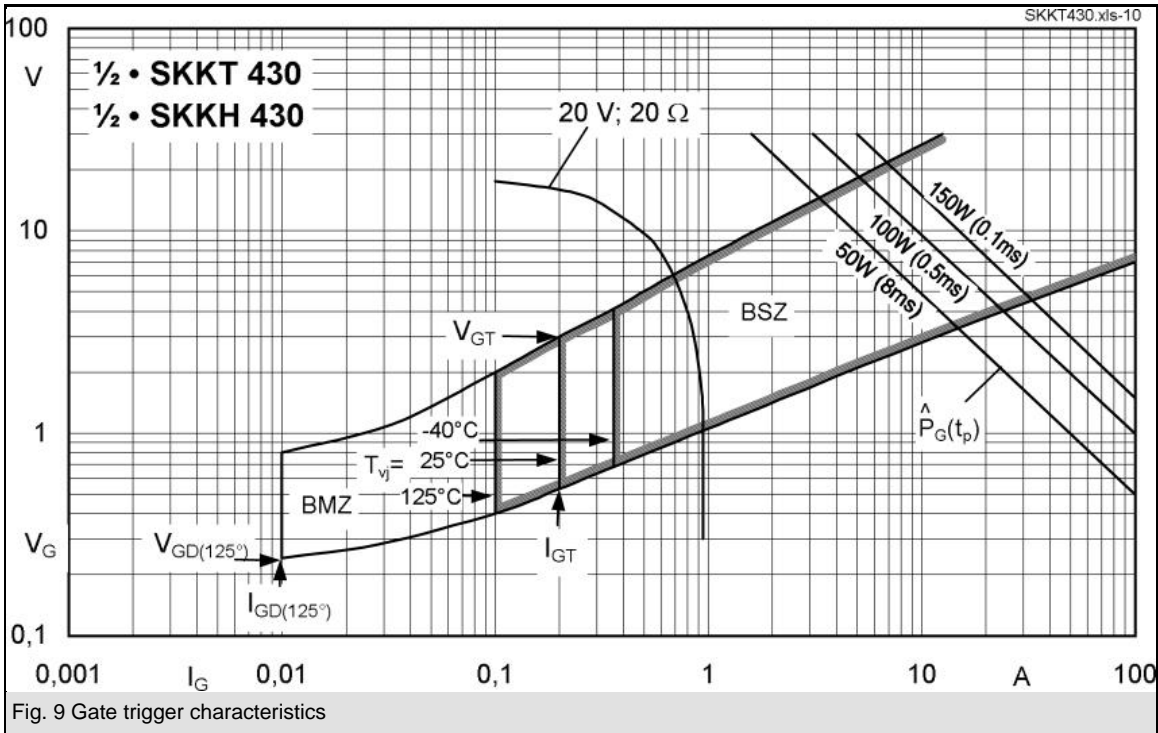

This technical information specifies semiconductor devices but promises no characteristics. No warranty or guarantee expressed or implied is made regarding delivery, performance or suitability.