

# SKKD 100, SKMD 100



## SEMIPACK<sup>®</sup> 1

### Rectifier Diode Modules

**SKKD 100**

**SKMD 100**

#### Features

- Heat transfer through aluminium oxide ceramic isolated metal baseplate
- Hard soldered joints for high reliability
- SKKD half bridge connection  
center-tap connections
- SKMD common cathode
- UL recognized, file no. E 63 532

#### Typical Applications

- Non-controllable rectifiers for AC/AC converters
- Line rectifiers for transistorized AC motor controllers
- Field supply for DC motors

$V_{RSM}$ V	$V_{RRM}$ V	$I_{FRMS} = 175$ A (maximum value for continuous operation) $I_{FAV} = 100$ A (sin. 180; $T_c = 85$ °C)	
500	400	SKKD 100/04	SKMD 100/04
900	800	SKKD 100/08	SKMD 100/08
1300	1200	SKKD 100/12	
1500	1400	SKKD 100/14	SKMD 100/14
1700	1600	SKKD 100/16	SKMD 100/16
1900	1800	SKKD 100/18	

Symbol	Conditions	Values	Units
$I_{FAV}$	sin. 180; $T_c = 85$ (100) °C	100 (67)	A
$I_D$	P3/180; $T_a = 45$ °C; B2 / B6	73 / 91	A
	P3/180F; $T_a = 35$ °C; B2 / B6	150 / 190	A
$I_{FSM}$	$T_{vj} = 25$ °C; 10 ms	2500	A
	$T_{vj} = 125$ °C; 10 ms	2000	A
$i^2t$	$T_{vj} = 25$ °C; 8,3 ... 10 ms	31250	A <sup>2</sup> s
	$T_{vj} = 125$ °C; 8,3 ... 10 ms	20000	A <sup>2</sup> s
$V_F$	$T_{vj} = 25$ °C; $I_F = 300$ A	max. 1,35	V
$V_{(TO)}$	$T_{vj} = 125$ °C	0,85	V
$r_T$	$T_{vj} = 125$ °C	1,3	mΩ
$I_{RD}$	$T_{vj} = 125$ °C; $V_{RD} = V_{RRM}$	max. 5	mA
$R_{th(j-c)}$	per diode / per module	0,35 / 0,175	K/W
$R_{th(c-s)}$	per diode / per module	0,2 / 0,1	K/W
$T_{vj}$		- 40 ... + 125	°C
$T_{stg}$		- 40 ... + 125	°C
$V_{isol}$	a. c. 50 Hz; r.m.s.; 1 s / 1 min.	3600 / 3000	V~
$M_s$	to heatsink	5 ± 15 %	Nm
$M_t$	to terminals	3 ± 15 %	Nm
a		5 * 9,81	m/s <sup>2</sup>
m	approx.	95	g
Case	SKKD	A 10	
	SKMD	A 33	

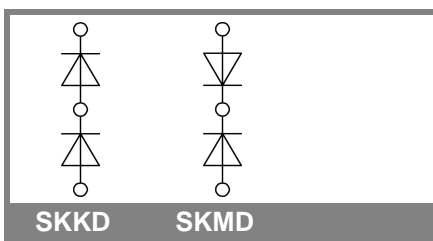

# SKKD 100, SKMD 100

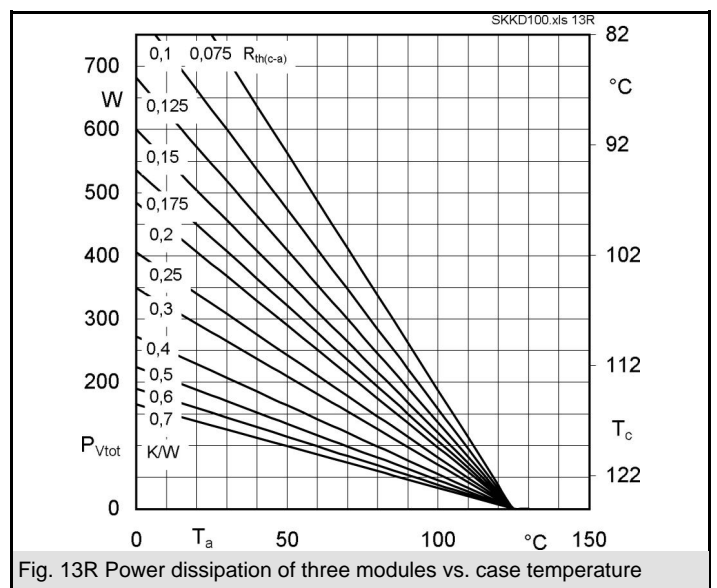
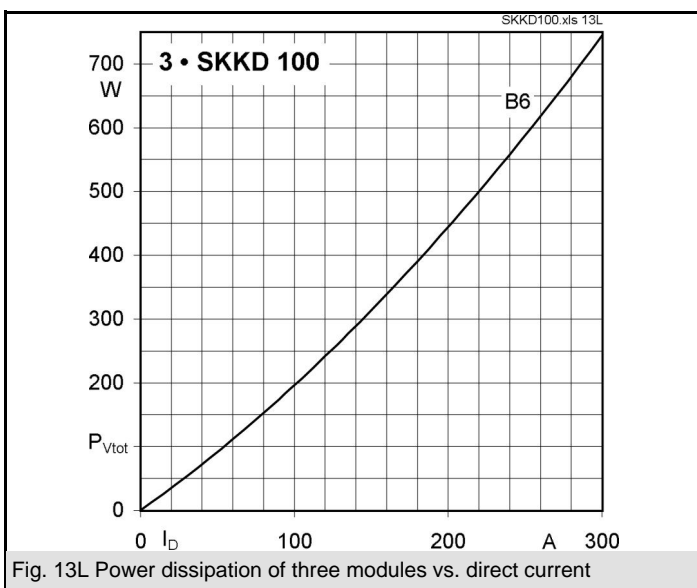
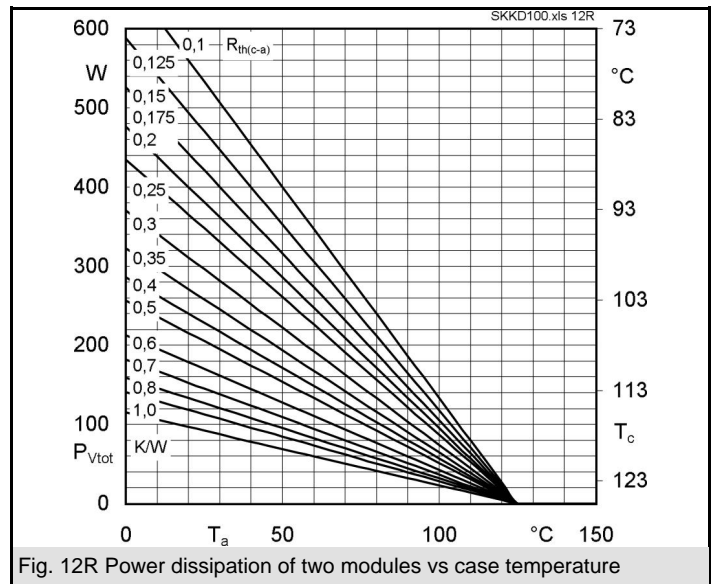
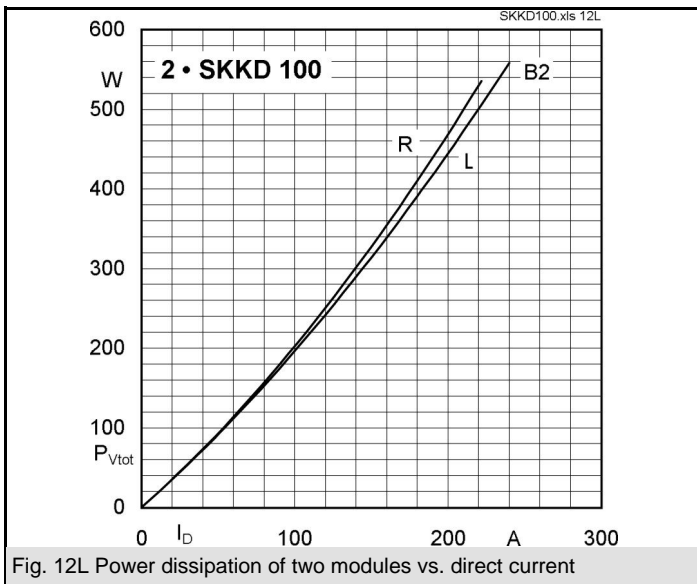
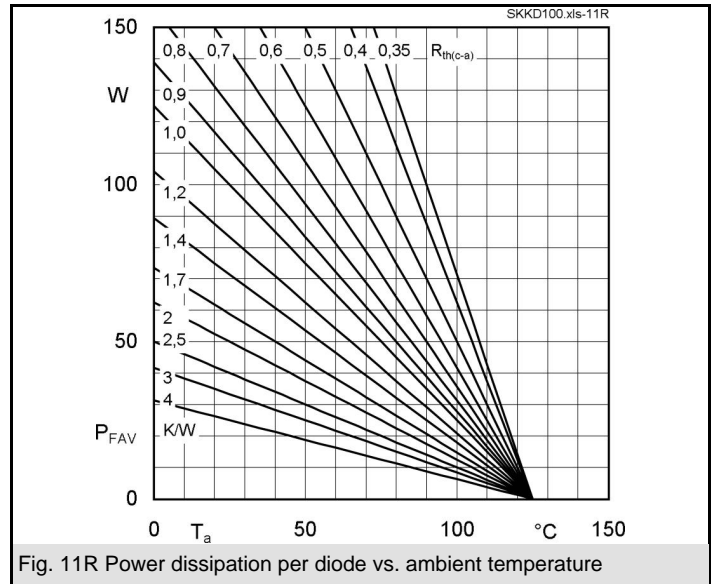
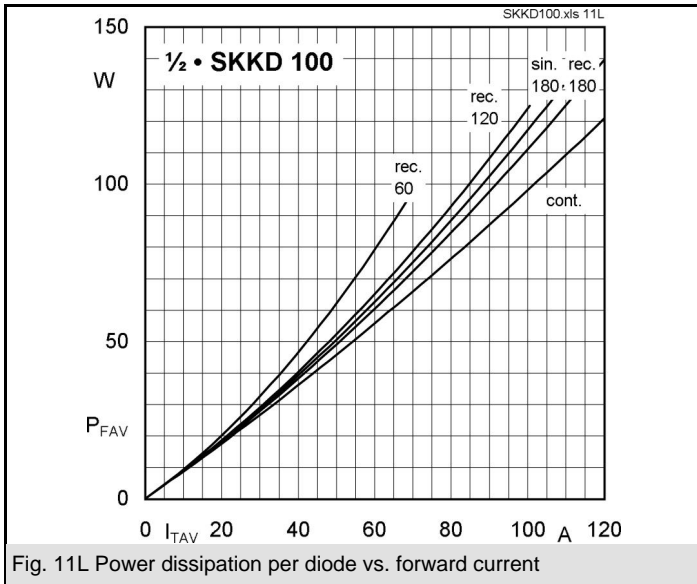

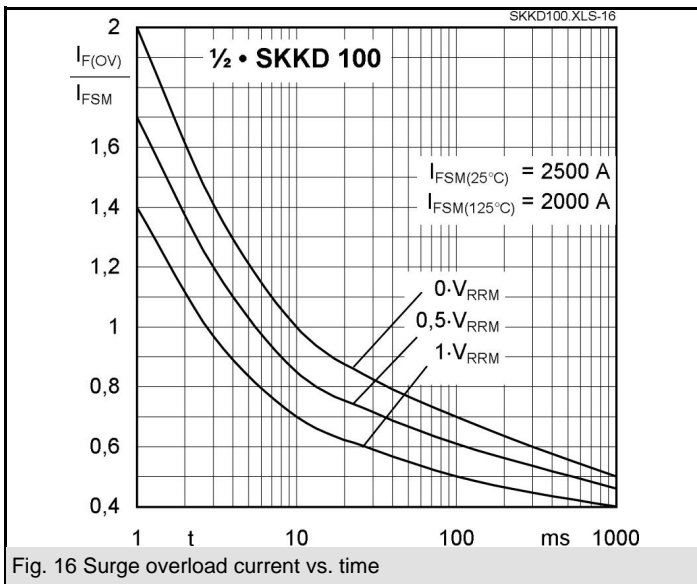
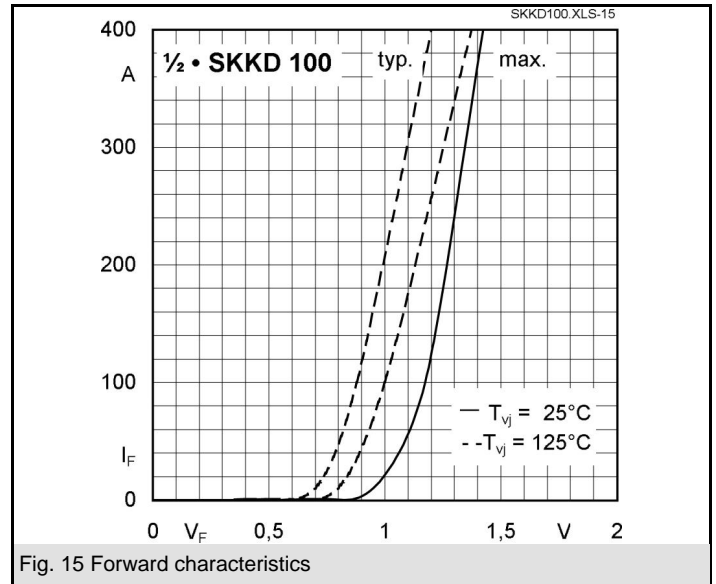
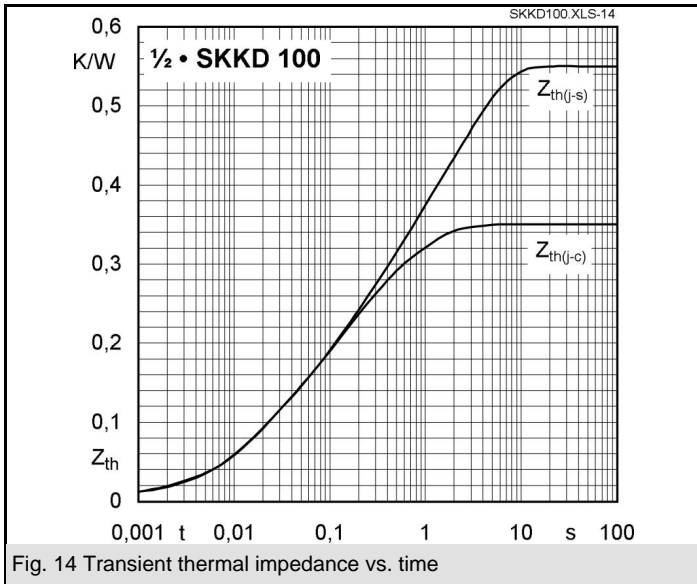

# SKKD 100, SKMD 100

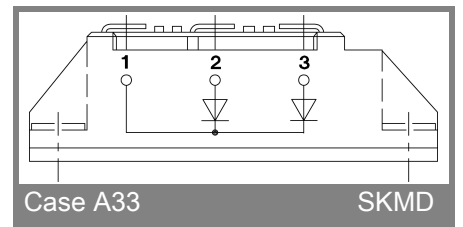
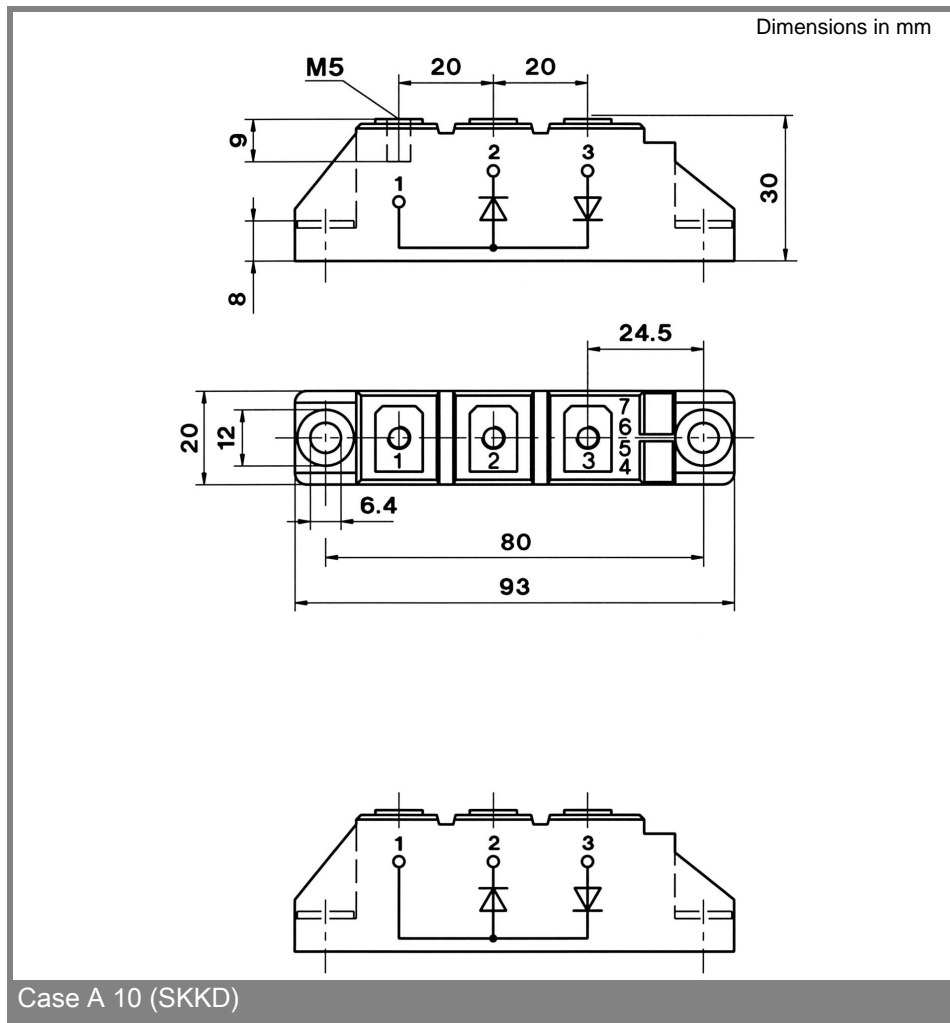

This technical information specifies semiconductor devices but promises no characteristics. No warranty or guarantee expressed or implied is made regarding delivery, performance or suitability.