

SKD 110, SKD 160

V_{RSM} V_{RRM} V	I_D ($T_{case} = 100\text{ °C}$)	
	110 A	160 A
400	SKD 110/04	SKD 160/04
800	SKD 110/08	SKD 160/08
1200	SKD 110/12	SKD 160/12
1400	SKD 110/14	SKD 160/14
1600	SKD 110/16	SKD 160/16
1800	SKD 110/18*	SKD 160/18*

SEMIPONT® 4 Power Bridge Rectifiers

SKD 110 SKD 160

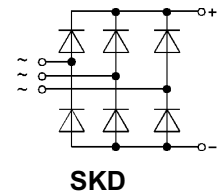

Symbol	Conditions	SKD 110	SKD 160	Units
I_D	$T_{case} = 100\text{ °C}$	110	160	A
	$T_{amb} = 45\text{ °C}$; chassis ¹⁾	28	30	A
	P1/200	70	75	A
	$T_{amb} = 35\text{ °C}$; P1/120F	110	145	A
	P3/120F	123	146	A
I_{FSM}	$T_{vj} = 25\text{ °C}$; 10 ms	1 200	1 800	A
	$T_{vj} = 150\text{ °C}$; 10 ms	1 000	1 500	A
i^2t	$T_{vj} = 25\text{ °C}$; 8,3 ... 10 ms	7 200	16 200	A ² s
	$T_{vj} = 150\text{ °C}$; 8,3 ... 10 ms	5 000	11 200	A ² s
V_F	$T_{vj} = 25\text{ °C}$; $I_F = 300\text{ A}$	1,9	1,65	V
$V_{(TO)}$	$T_{vj} = 150\text{ °C}$	0,85	0,85	V
r_T	$T_{vj} = 150\text{ °C}$	4	3	mΩ
I_{RD}	$T_{vj} = 25\text{ °C}$; $V_{RD} = V_{RRM}$	0,5	0,5	mA
	$T_{vj} = 150\text{ °C}$; $V_{RD} = V_{RRM}$	5	6	mA
R_{thjc}	per diode	0,9	0,65	°C/W
	total	0,15	0,11	°C/W
R_{thch}	total	0,03		°C/W
T_{vj}		- 40 ... + 150		°C
T_{stg}		- 40 ... + 125		°C
V_{isol}	a. c. 50...60 Hz; r.m.s.; 1 s / 1 min	3600 / 3000		V~
M_1	to heatsink	SI units	5 ± 15 %	Nm
		US units	44 ± 15 %	lb. in.
M_2	to terminals	SI units	5 ± 15 %	Nm
		US units	44 ± 15 %	lb. in.
w		240		g
Case		G 37		

Features

- Robust plastic case with screw terminals
- Large, isolated base plate
- Blocking voltage up to 1800 V
- High surge currents
- Easy chassis mounting
- UL recognized, file no. E 63 532

Typical Applications

- Three phase rectifiers for power supplies
- Input rectifiers for variable frequency drives
- Rectifiers for DC motor field supplies
- Battery charger rectifiers

* Available in limited quantities

¹⁾ Painted metal sheet of min. 250 x 250 x 1 mm; $R_{thca} = 1,8\text{ °C/W}$

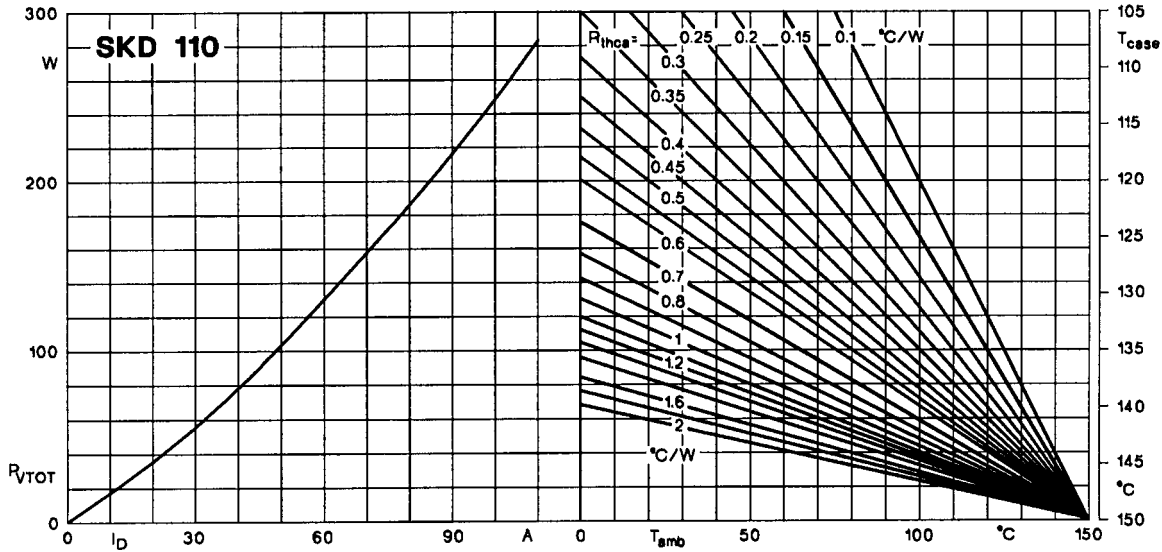

Fig. 3 a Power dissipation vs. output current and case temperature

	R_{thca}
P1/200	0,52 °C/W
P1/120 F	0,20 °C/W

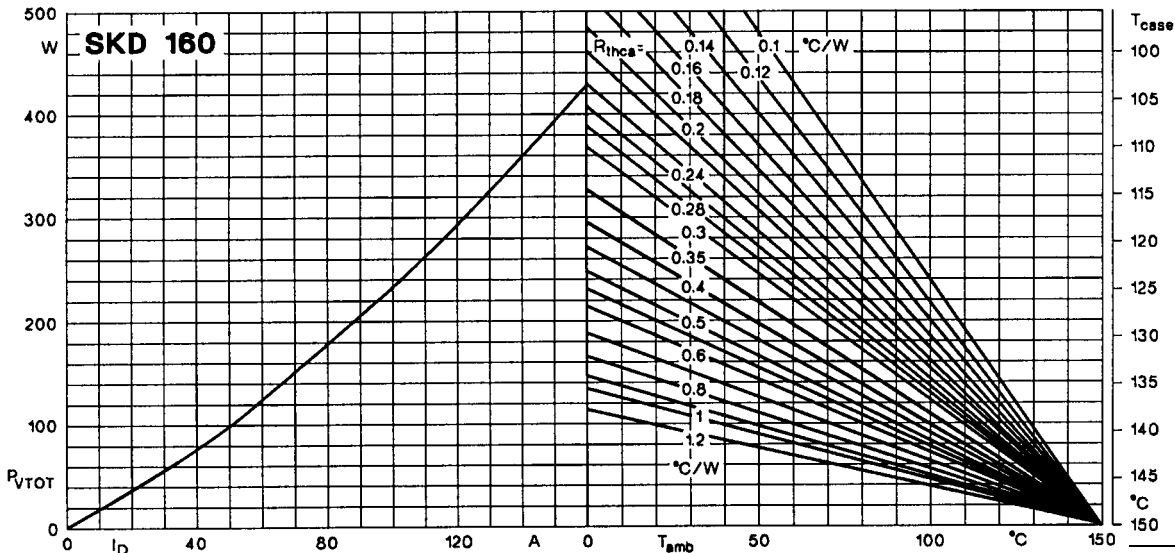

Fig. 3 b Power dissipation vs. output current and case temperature

	R_{thca}
P1/200	0,52 °C/W
P1/120 F	0,20 °C/W

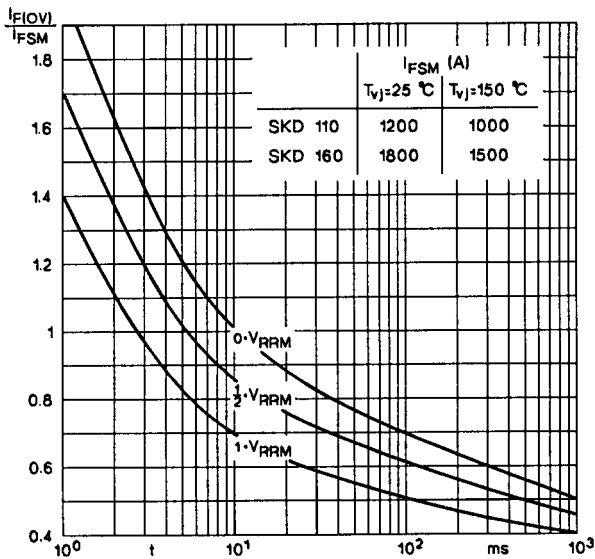

Fig. 5 Surge overload current vs. time

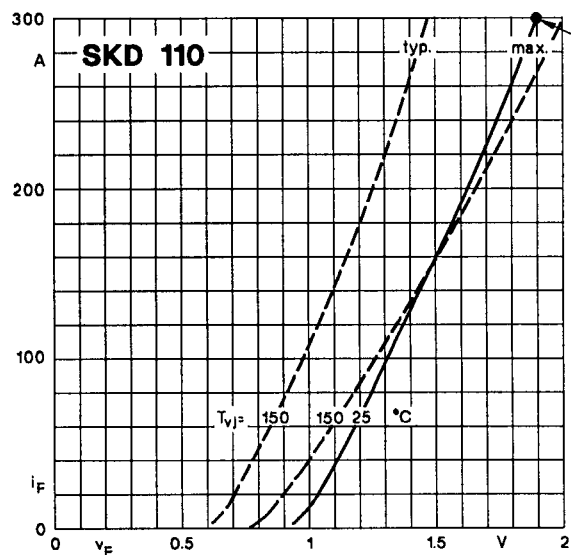

Fig. 9 a Forward characteristics of a single diode

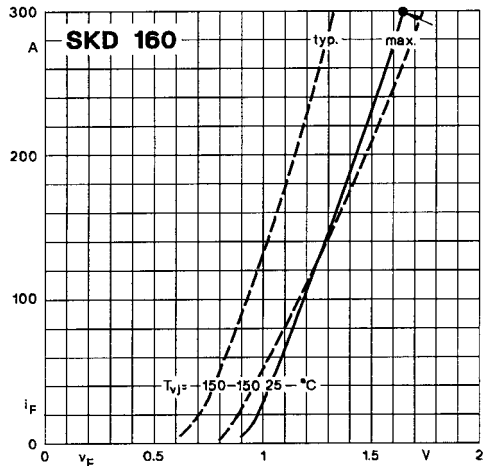

Fig. 9 b Forward characteristics of a single diode

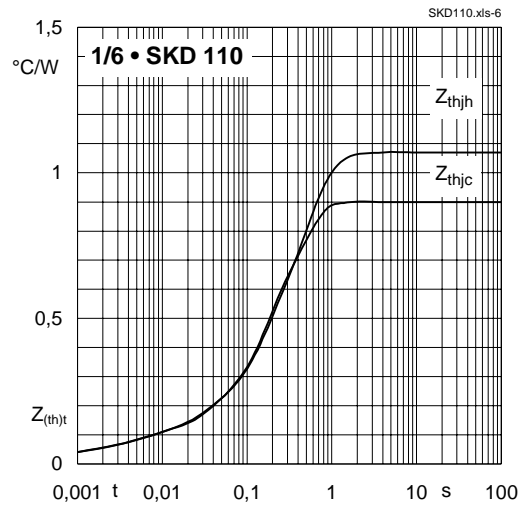

Fig. 12 a Transient thermal impedance vs. time

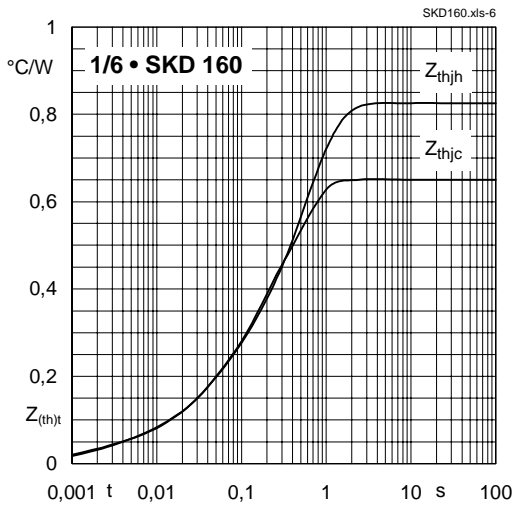

Fig. 12 b Transient thermal impedance vs. time

SKD 110, SKD 160

SKD 110
SKD 160

Case G 37

SEMIPONT® 4

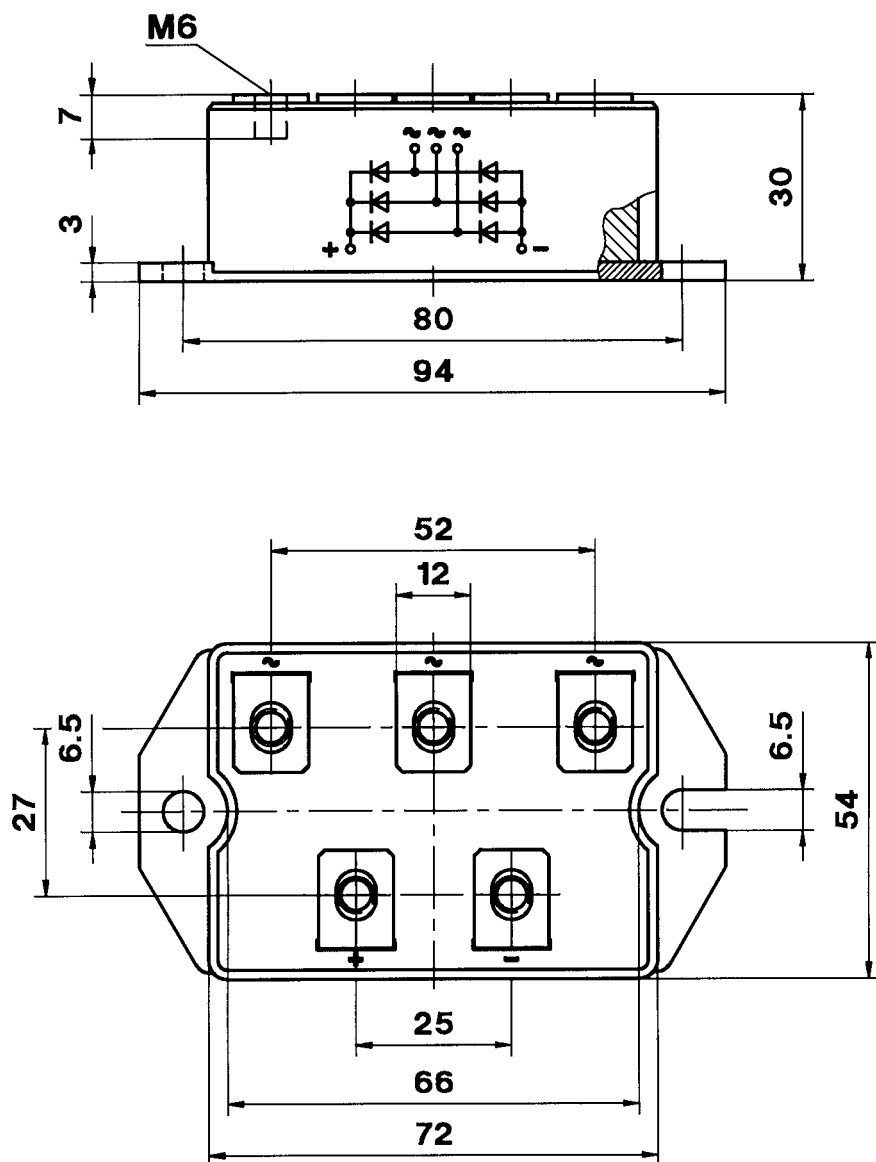

Dimensions in mm

This technical information specifies semiconductor devices but promises no characteristics. No warranty or guarantee expressed or implied is made regarding delivery, performance or suitability.