

SKBT 28



SEMIPONT[®] 1

Controllable Bridge Rectifiers

SKBT 28

Features

- Sturdy isolated metal baseplate
- Fast-on terminals with solder tips
- Suitable for wave soldering
- High surge current rating
- UL recognized, file no. E 63 532

Typical Applications

- Controllable single phase rectifier
- DC power supplies
- DC motor controllers
- DC motor field controllers

- 1) Painted metal shield of minimum 250 x 250 x 1 mm: $R_{th(c-a)} = 1,85 \text{ K/W}$
- 2) Freely suspended or mounted on insulator

V_{RSM} V	V_{RRM}, V_{DRM} V	$I_D = 28 \text{ A}$ (full conduction) ($T_c = 89 \text{ °C}$)
600	600	SKBT 28/06
800	800	SKBT 28/08
1200	1200	SKBT 28/12
1400	1400	SKBT 28/14

Symbol	Conditions	Values	Units
I_D	$T_c = 85 \text{ °C}$	30	A
	$T_a = 45 \text{ °C}$; chassis 1)	13	A
	$T_a = 45 \text{ °C}$; P5A/100	15	A
	$T_a = 45 \text{ °C}$; P13A/125	16	A
	$T_a = 45 \text{ °C}$; P1A/120	23	A
I_{TSM}, I_{FSM}	$T_{vj} = 25 \text{ °C}$; 10 ms	320	A
	$T_{vj} = 125 \text{ °C}$; 10 ms	280	A
i^2t	$T_{vj} = 25 \text{ °C}$; 8,3 ... 10 ms	510	A ² s
	$T_{vj} = 125 \text{ °C}$; 8,3 ... 10 ms	390	A ² s
V_T	$T_{vj} = 25 \text{ °C}$; $I_T = 75 \text{ A}$	max. 2,25	V
$V_{T(TO)}$	$T_{vj} = 125 \text{ °C}$;	1	V
r_T	$T_{vj} = 125 \text{ °C}$	16	mΩ
I_{DD}, I_{RD}	$T_{vj} = 125 \text{ °C}$; $V_{DD} = V_{DRM}$; $V_{RD} = V_{RRM}$	max. 8	mA
t_{gd}	$T_{vj} = 25 \text{ °C}$; $I_G = 1 \text{ A}$; $di_G/dt = 1 \text{ A}/\mu\text{s}$	1	μs
t_{gr}	$V_D = 0,67 \cdot V_{DRM}$	1	μs
$(dv/dt)_{cr}$	$T_{vj} = 125 \text{ °C}$	max. 500	V/μs
$(di/dt)_{cr}$	$T_{vj} = 125 \text{ °C}$; $f = 50 \text{ Hz}$	max. 50	A/μs
t_q	$T_{vj} = 125 \text{ °C}$; typ.	80	μs
I_H	$T_{vj} = 25 \text{ °C}$; typ. / max.	50 / 150	mA
I_L	$T_{vj} = 25 \text{ °C}$; $R_G = 33 \text{ Ω}$	100 / 300	mA
V_{GT}	$T_{vj} = 25 \text{ °C}$; d.c.	min. 2	V
I_{GT}	$T_{vj} = 25 \text{ °C}$; d.c.	min. 100	mA
V_{GD}	$T_{vj} = 125 \text{ °C}$; d.c.	max. 0,25	V
I_{GD}	$T_{vj} = 125 \text{ °C}$; d.c.	max. 3	mA
$R_{th(j-c)}$	per thyristor / diode	1,8	K/W
	total	0,45	K/W
	$R_{th(c-s)}$ total	0,1	K/W
	$R_{th(j-a)}$ total 2)	15	K/W
T_{vj}		- 40 ... + 125	°C
T_{stg}		- 40 ... + 125	°C
V_{isol}	a. c. 50 Hz; r.m.s.; 1 s / 1 min.	3600 (3000)	V
M_s	case to heatsink	2	Nm
M_t		n.a.	Nm
m		66	g
Case	SKBT	G 22	

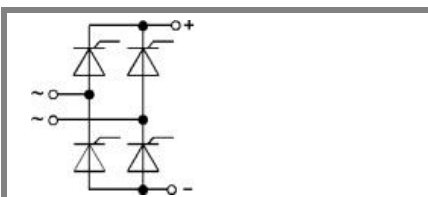

SKBT

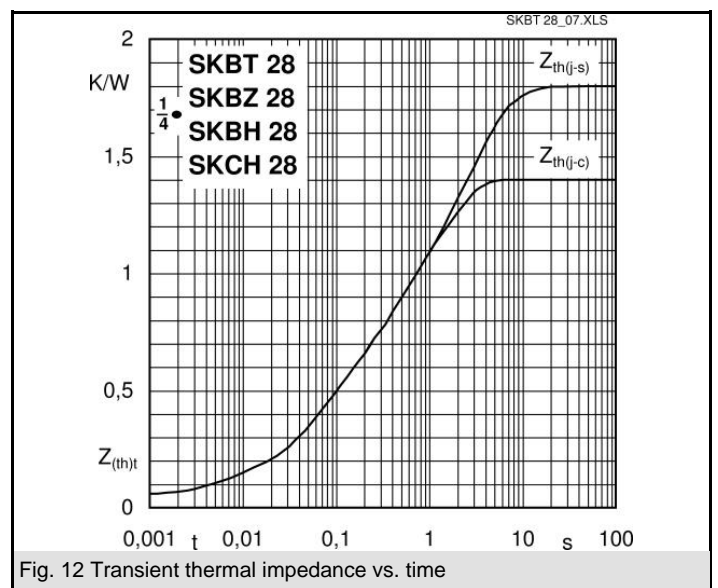
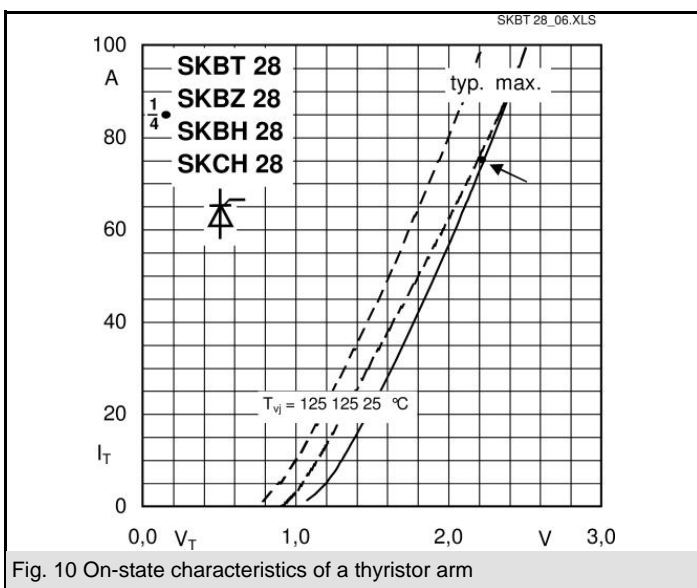
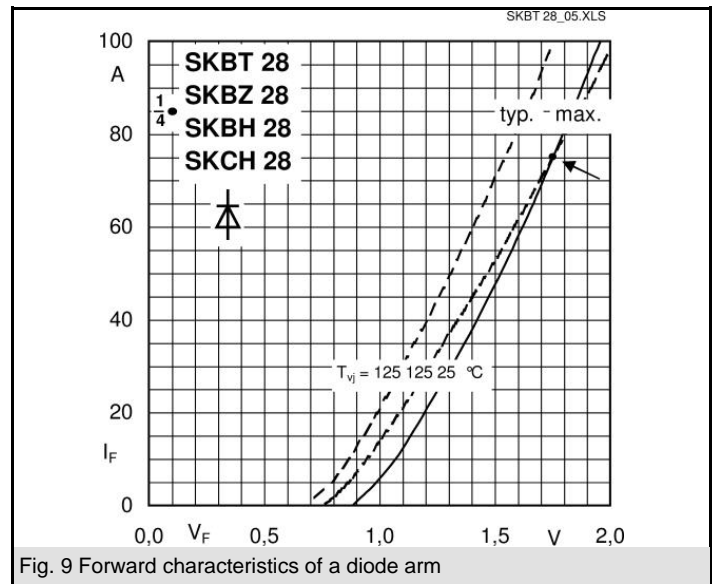
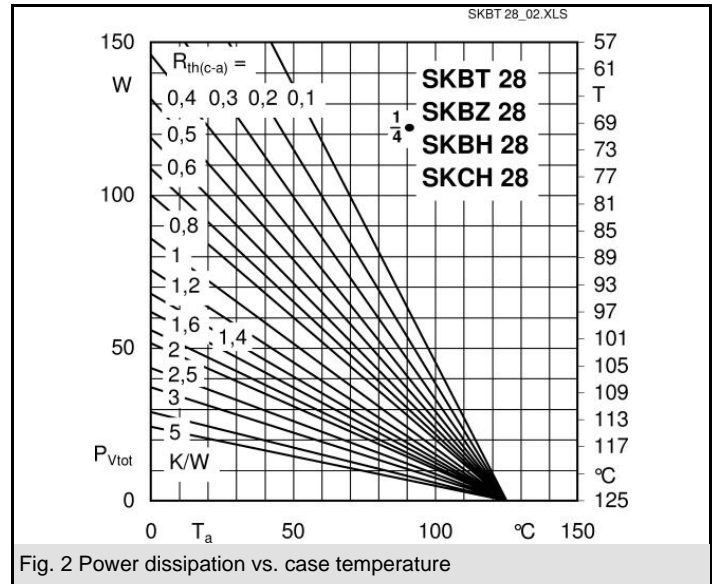

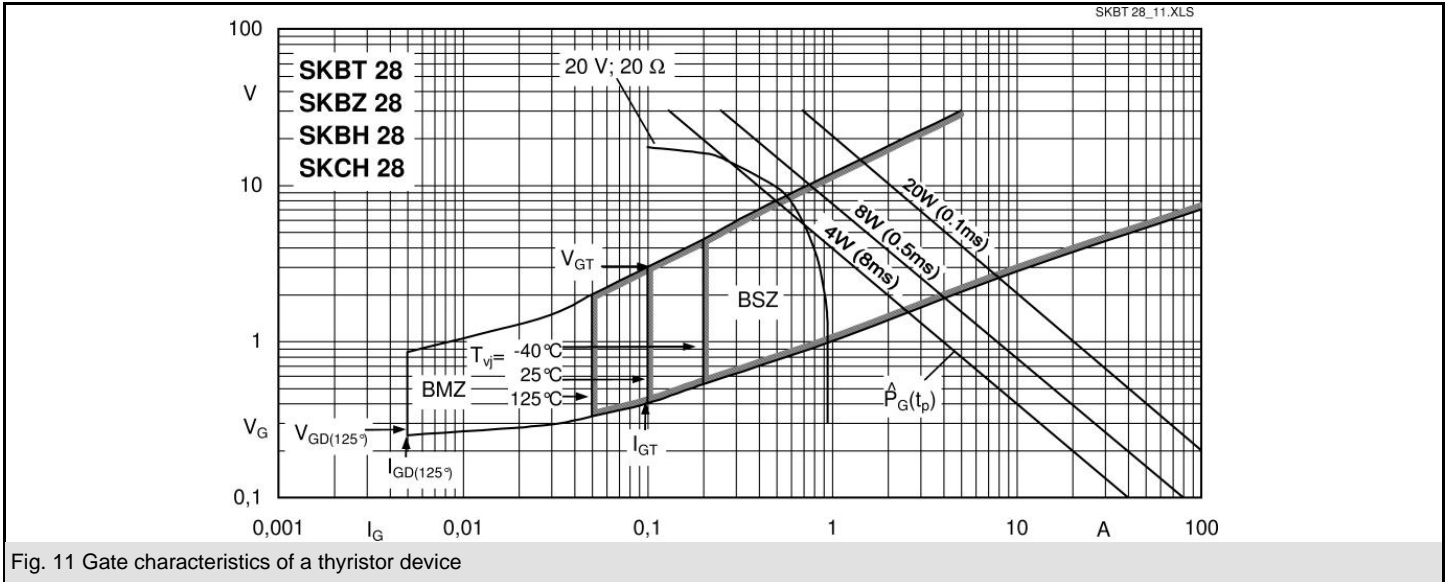
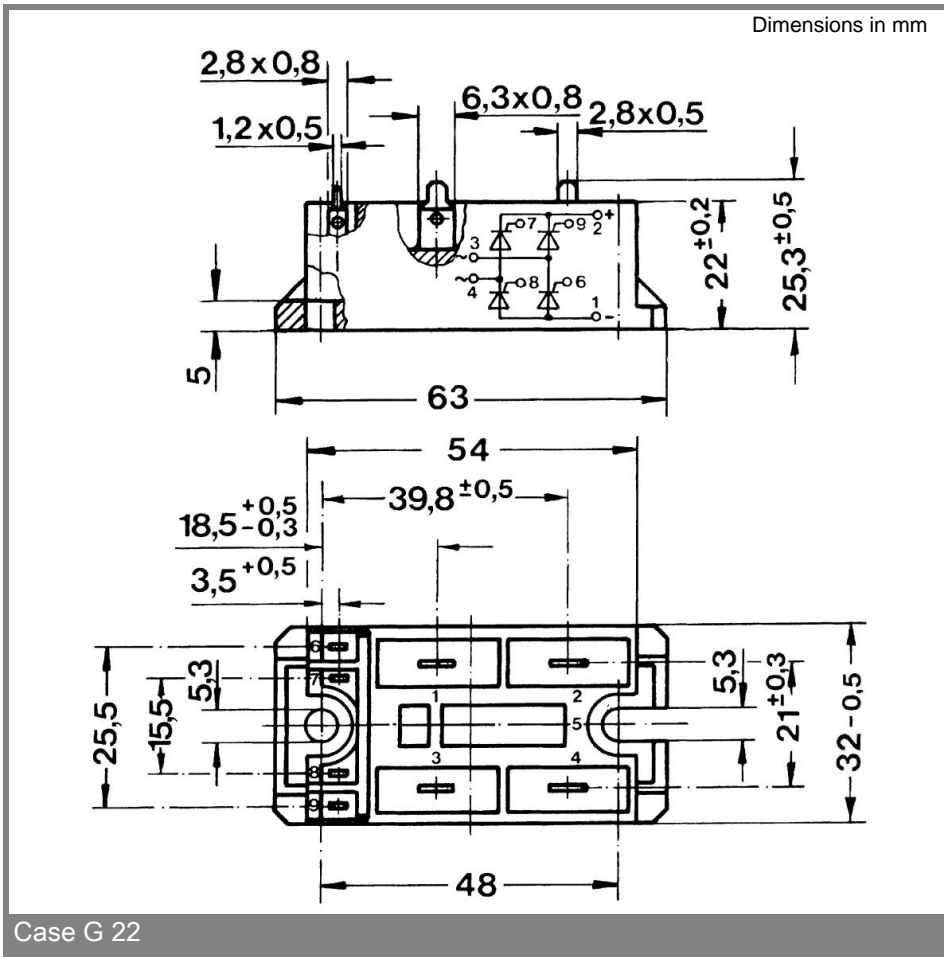

Fig. 11 Gate characteristics of a thyristor device



This technical information specifies semiconductor devices but promises no characteristics. No warranty or guarantee expressed or implied is made regarding delivery, performance or suitability.