

SK 70 DH

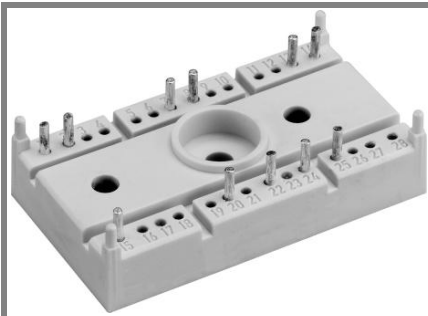

SEMITOP® 3

Half Controlled Bridge Rectifier

SK 70 DH

Preliminary Data

Features

- Compact design
- One screw mounting
- Heat transfer and insulation through direct copper bonded aluminium oxide ceramic (DBC)
- Glass passivated thyristor chips
- Up to 1600V reverse voltage
- UL recognized, file no. E 63 532

Typical Applications

- Soft starters
- Light control
- Temperature control
- Motor control

V_{RSM} V	V_{RRM}, V_{DRM} V	$I_D = 68 \text{ A}$ (full conduction) ($T_s = 80 \text{ °C}$)
900	800	SK 70 DH 08
1300	1200	SK 70 DH 12
1700	1600	SK 70 DH 16

Symbol	Conditions	Values	Units
I_D	$T_s = 80 \text{ °C}$	68	A
I_{FSM} / I_{TSM}	$T_{vj} = 25 \text{ °C}; 10 \text{ ms}$ $T_{vj} = 125 \text{ °C}; 10 \text{ ms}$	370 280	A A
i^2t	$T_{vj} = 25 \text{ °C}; 8,3 \dots 10 \text{ ms}$ $T_{vj} = 125 \text{ °C}; 8,3 \dots 10 \text{ ms}$	685 365	A^2s A^2s
V_T	$T_{vj} = 25 \text{ °C}; 75\text{A}$	max. 1,9	V
$V_{T(TO)}$	$T_{vj} = 125 \text{ °C};$	1	V
r_T	$T_{vj} = 125 \text{ °C}$	10	$\text{m}\Omega$
$I_{DD}; I_{RD}$	$T_{vj} = 125 \text{ °C}; V_{DD} = V_{DRM}; V_{RD} = V_{RRM}$	max. 10	mA
t_{gd}	$T_{vj} = 25 \text{ °C}; I_G = 1 \text{ A}; di_G/dt = 1 \text{ A}/\mu\text{s}$	1	μs
t_{gr}	$V_D = 0,67 \cdot V_{DRM}$	2	μs
$(dv/dt)_{cr}$	$T_{vj} = 125 \text{ °C}; \text{d.c.}$	max. 1000	$\text{V}/\mu\text{s}$
$(di/dt)_{cr}$	$T_{vj} = 125 \text{ °C}; \text{d.c.}; f = 50 \dots 60 \text{ Hz}$	max. 50	$\text{A}/\mu\text{s}$
t_q	$T_{vj} = 125 \text{ °C}; \text{d.c.}; \text{typ.}$	120	μs
I_H	$T_{vj} = 25 \text{ °C}; \text{d.c.}; \text{typ.} / \text{max.}$	80 / 150	mA
I_L	$T_{vj} = 25 \text{ °C}; \text{d.c.}; R_G = 33 \Omega$	150 / 300	mA
V_{GT}	$T_{vj} = 25 \text{ °C}; \text{d.c.}$	min. 2	V
I_{GT}	$T_{vj} = 25 \text{ °C}; \text{d.c.}$	min. 100	mA
V_{GD}	$T_{vj} = 125 \text{ °C}; \text{d.c.}$	max. 0,25	V
I_{GD}	$T_{vj} = 125 \text{ °C}; \text{d.c.}$	max. 3	mA
$R_{th(j-s)}$	Per thyristor	1,2	K/W
	Per diode	1,7	K/W
T_{solder}	Terminals, 10s	260	$^{\circ}\text{C}$
T_{vj}	Diodes	-40...+150	$^{\circ}\text{C}$
T_{vj}			$^{\circ}\text{C}$
T_{stg}		-40...+125	$^{\circ}\text{C}$
T_{vj}	Thyristors	-40...+125	$^{\circ}\text{C}$
V_{isol}	a. c. 50 Hz; r.m.s.; 1 s / 1 min.	3000 (2500)	V
M_s	Mounting torque to heatsink	2,5	Nm
a			m/s^2
m	weight	30	g
Case	SEMITOP® 3	T 40	

www.DataSheet.in

DH

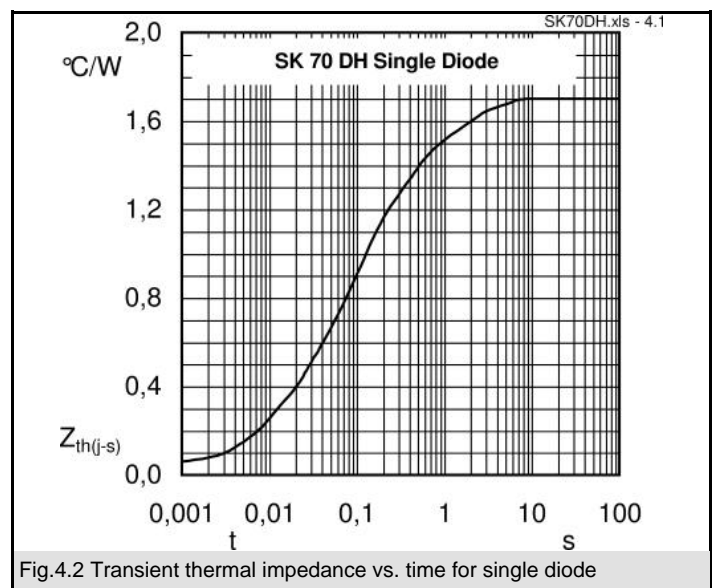
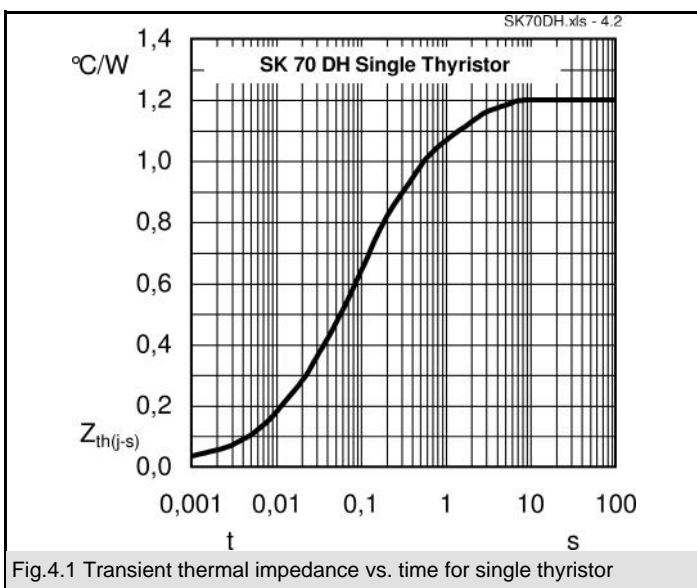
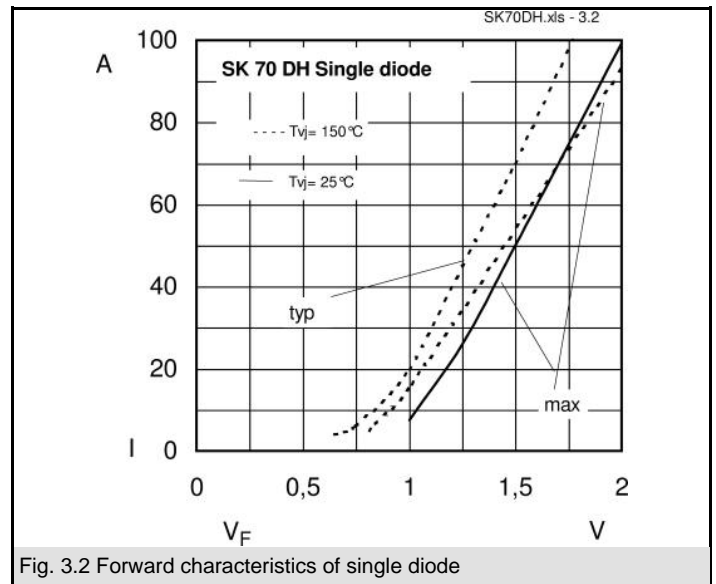
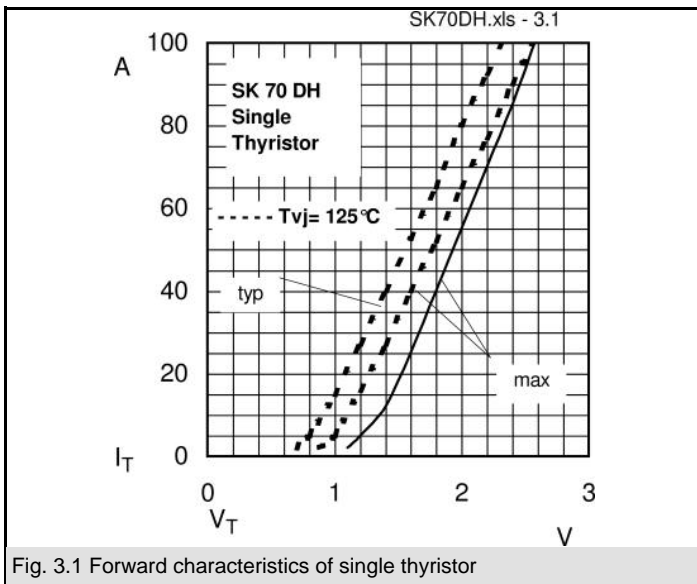
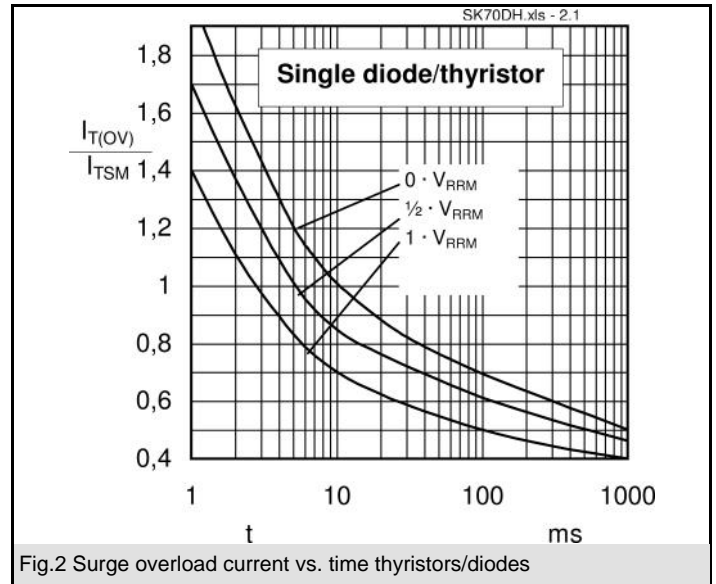
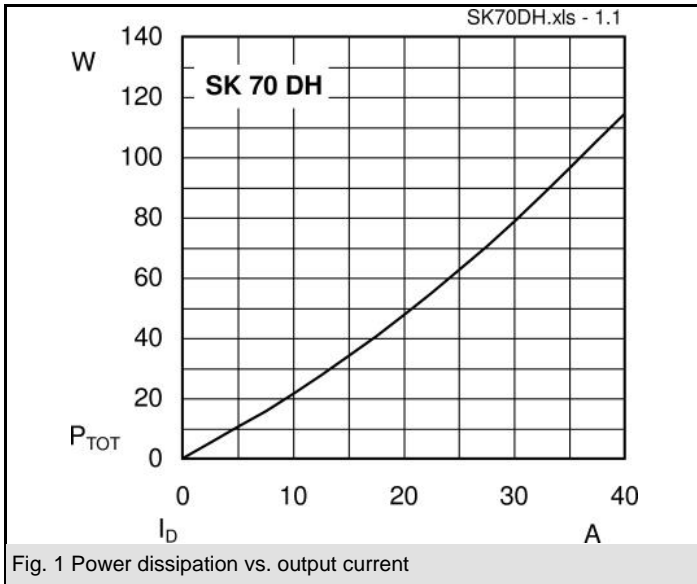

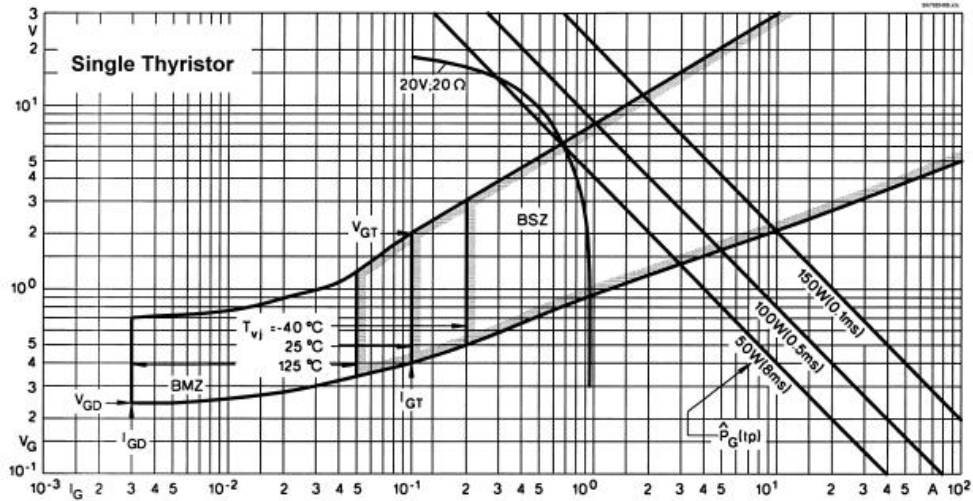
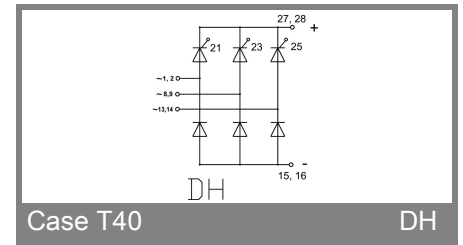
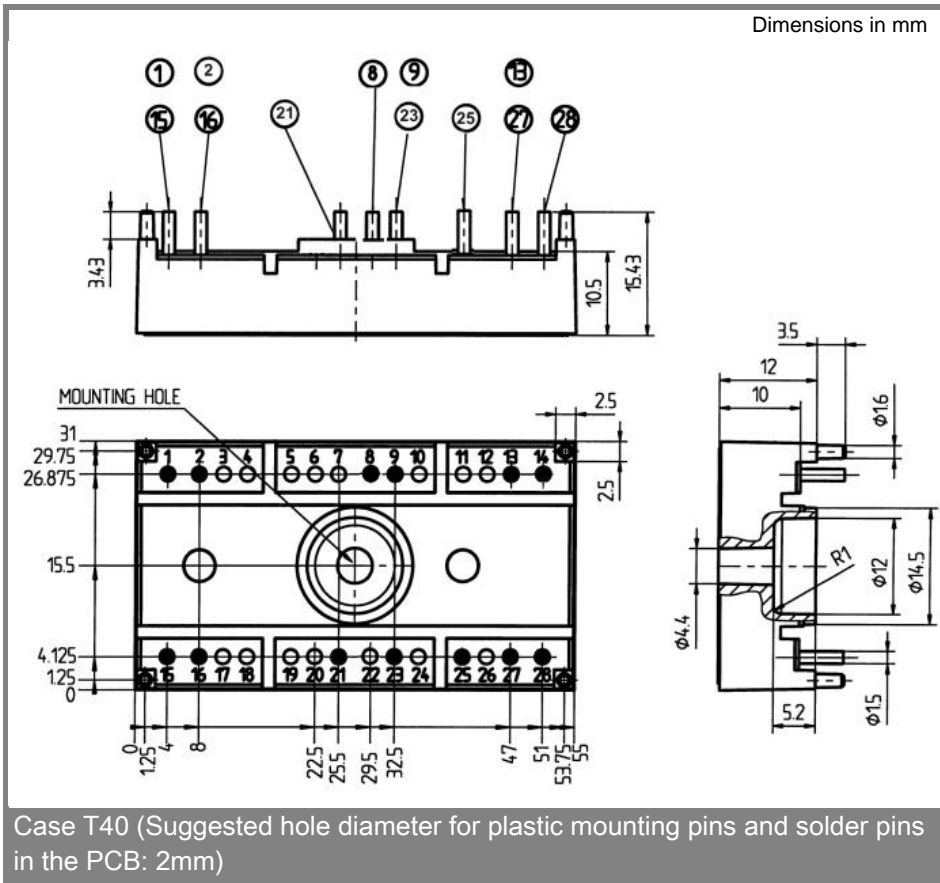

Fig. 5 Gate trigger characteristics



This technical information specifies semiconductor devices but promises no characteristics. No warranty or guarantee expressed or implied is made regarding delivery, performance or suitability.