



SEMITOP® 3

IGBT Module

SK40GB067

SK40GAL067

SK40GAR067

Target Data

Features

- Compact design
- One screw mounting
- Heat transfer and isolation through direct copper bonded aluminium oxide ceramic (DCB)
- Hyperfast NPT technology IGBT
- N-channel homogeneous silicon structure (NPT Non-Punch-Through IGBT)
- Positive $V_{ce,sat}$ temperature coefficient (Easy paralleling)
- Low tail current with low temperature dependence
- Low threshold voltage

Typical Applications*

- Switching (not for linear use)
- High Frequencies Applications
- Welding generator
- Switched mode power supplies
- UPS

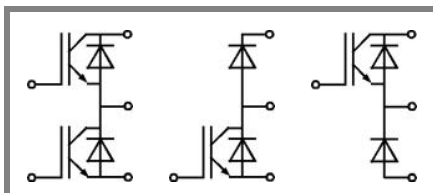

GB

GAL

GAR

Absolute Maximum Ratings		$T_s = 25\text{ °C}$, unless otherwise specified		
Symbol	Conditions	Values		Units
IGBT				
V_{CES}	$T_j = 25\text{ °C}$	600		V
I_C	$T_j = 125\text{ °C}$	$T_s = 25\text{ °C}$	62	A
		$T_s = 80\text{ °C}$	41	A
I_{CRM}	$I_{CRM} = 2 \times I_{Cnom}$	180		A
V_{GES}		± 20		V
t_{psc}	$V_{CC} = 300\text{ V}; V_{GE} \leq 20\text{ V}; T_j = 125\text{ °C}$ $V_{CES} < 600\text{ V}$	10		µs
Inverse Diode				
I_F	$T_j = 150\text{ °C}$	$T_s = 25\text{ °C}$	62	A
		$T_s = 80\text{ °C}$	38	A
I_{FRM}	$I_{FRM} = 2 \times I_{Fnom}$			A
I_{FSM}	$t_p = 10\text{ ms}$; sinusoidal	$T_j = \text{ °C}$	270	A
Freewheeling Diode				
I_F	$T_j = 150\text{ °C}$	$T_s = 25\text{ °C}$	62	A
		$T_s = 80\text{ °C}$	38	A
I_{FRM}	$I_{FRM} = 2 \times I_{Fnom}$			A
I_{FSM}	$t_p = 10\text{ ms}$;	$T_j = \text{ °C}$	270	A
Module				
$I_{t(RMS)}$				A
T_{vj}		-40 ... +150		°C
T_{stg}		-40 ... +125		°C
V_{isol}	AC, 1 min.	2500		V

Characteristics		$T_s = 25\text{ °C}$, unless otherwise specified				
Symbol	Conditions	min.	typ.	max.	Units	
IGBT						
$V_{GE(th)}$	$V_{GE} = V_{CE}, I_C = 0,9\text{ mA}$	3	4	5	V	
I_{CES}	$V_{GE} = 0\text{ V}, V_{CE} = V_{CES}, T_j = 25\text{ °C}$			0,006	mA	
I_{GES}	$V_{CE} = 0\text{ V}, V_{GE} = 20\text{ V}, T_j = 25\text{ °C}$			360	nA	
V_{CE0}	$T_j = 150\text{ °C}$			2	V	
r_{CE}	$V_{GE} = 15\text{ V}, T_j = 150\text{ °C}$			17	mΩ	
$V_{CE(sat)}$	$I_{Cnom} = 90\text{ A}, V_{GE} = 15\text{ V}$	$T_j = 25\text{ °C}_{chiplev.}$	2,8	3,15	V	
		$T_j = 125\text{ °C}_{chiplev.}$	3,5	4	V	
C_{ies}	$V_{CE} = 25, V_{GE} = 0\text{ V}, f = 1\text{ MHz}$			4,5	nF	
C_{oes}				0,45	nF	
C_{res}				0,27	nF	
$t_{d(on)}$	$R_{Gon} = 0\text{ Ω}$	$V_{CC} = 400\text{ V}$ $I_C = 90\text{ A}$			40	ns
t_r					90	ns
E_{on}	$R_{Goff} = 11\text{ Ω}$	$T_j = 125\text{ °C}$ $V_{GE} = \pm 15\text{ V}$			2,44	mJ
$t_{d(off)}$					262	ns
t_f					30	ns
E_{off}					2,54	mJ
$R_{th(j-s)}$	per IGBT			0,6	K/W	

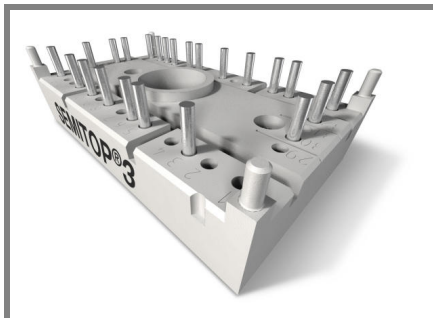

SEMITOP[®] 3

IGBT Module

SK40GB067

SK40GAL067

SK40GAR067

Target Data

Features

- Compact design
- One screw mounting
- Heat transfer and isolation through direct copper bonded aluminium oxide ceramic (DCB)
- Hyperfast NPT technology IGBT
- N-channel homogeneous silicon structure (NPT Non-Punch-Through IGBT)
- Positive $V_{ce,sat}$ temperature coefficient (Easy paralleling)
- Low tail current with low temperature dependence
- Low threshold voltage

Typical Applications*

- Switching (not for linear use)
- High Frequencies Applications
- Welding generator
- Switched mode power supplies
- UPS

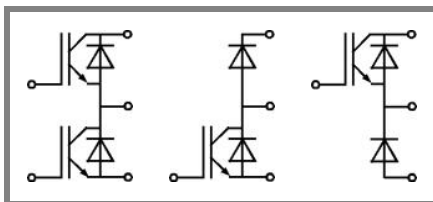

GB

GAL

GAR

Characteristics

Symbol	Conditions	min.	typ.	max.	Units
Inverse Diode					
$V_F = V_{EC}$	$I_{Fnom} = 90 \text{ A}; V_{GE} = 0 \text{ V}$			2	V
					$T_j = 25 \text{ }^\circ\text{C}_{chiplev.}$
			1,25		$T_j = 150 \text{ }^\circ\text{C}_{chiplev.}$
V_{F0}					$T_j = 25 \text{ }^\circ\text{C}$
			1		$T_j = 150 \text{ }^\circ\text{C}$
r_F					$T_j = 25 \text{ }^\circ\text{C}$
			5,5		$T_j = 150 \text{ }^\circ\text{C}$
I_{RRM}	$I_F = 90 \text{ A}$		7,5		A
Q_{rr}	$di/dt = -270 \text{ A}/\mu\text{s}$		4,65		μC
E_{rr}	$V_{CC} = 400\text{V}$		0,93		mJ
$R_{th(j-s)D}$	per diode			1,2	K/W
Free-wheeling diode					
$V_F = V_{EC}$	$I_{Fnom} = 90 \text{ A}; V_{GE} = 0 \text{ V}$			2	V
					$T_j = 25 \text{ }^\circ\text{C}_{chiplev.}$
			1,25		$T_j = 150 \text{ }^\circ\text{C}_{chiplev.}$
V_{F0}					$T_j = 25 \text{ }^\circ\text{C}$
			1		$T_j = 150 \text{ }^\circ\text{C}$
r_F					$T_j = 25 \text{ }^\circ\text{C}$
			5,5		$T_j = 150 \text{ }^\circ\text{C}$
I_{RRM}	$I_F = 90 \text{ A}$		7,5		A
Q_{rr}	$di/dt = -270 \text{ A}/\mu\text{s}$		4,65		μC
E_{rr}	$V_{CC} = 400\text{V}$		0,93		mJ
$R_{th(j-s)FD}$	per diode			1,2	K/W
M_s	to heat sink	2,25		2,5	Nm
w			29		g

This is an electrostatic discharge sensitive device (ESDS), international standard IEC 60747-1, Chapter IX.

* The specifications of our components may not be considered as an assurance of component characteristics. Components have to be tested for the respective application. Adjustments may be necessary. The use of SEMIKRON products in life support appliances and systems is subject to prior specification and written approval by SEMIKRON. We therefore strongly recommend prior consultation of our personal.

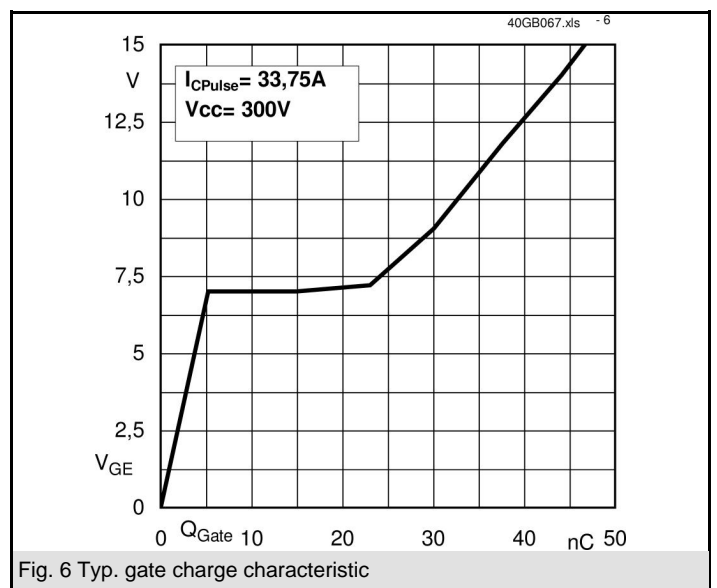
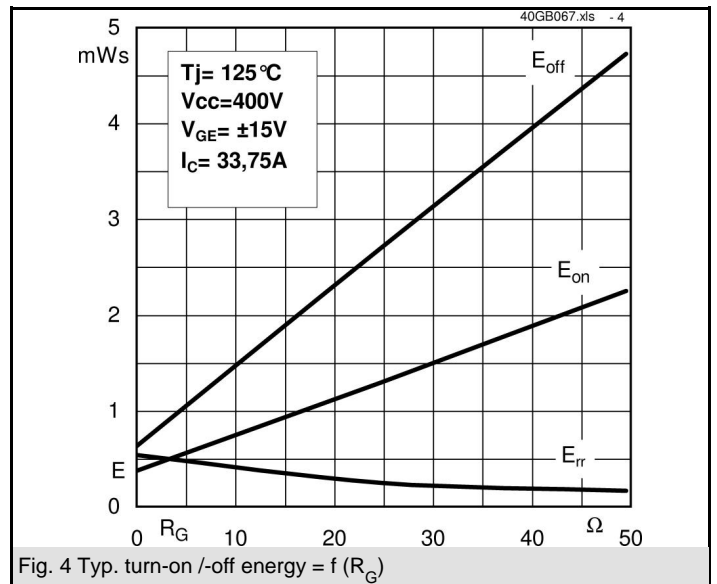
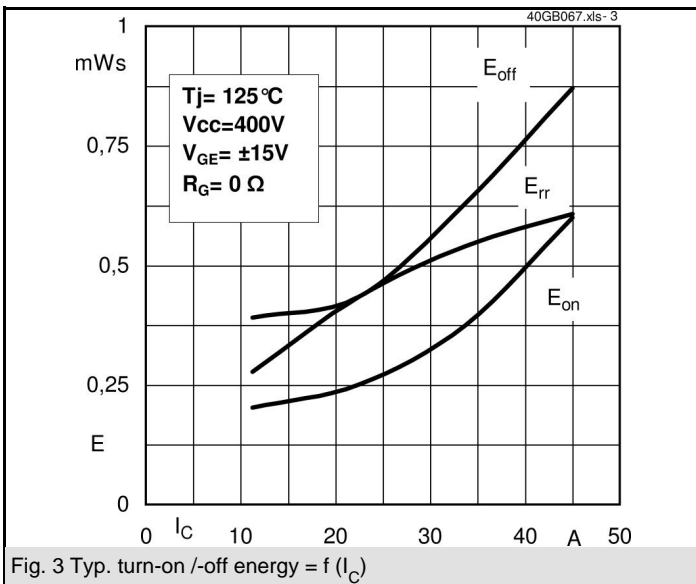
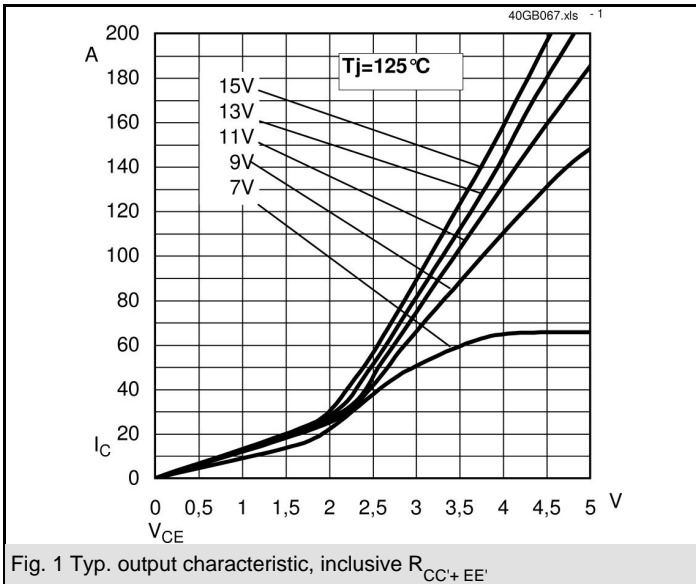

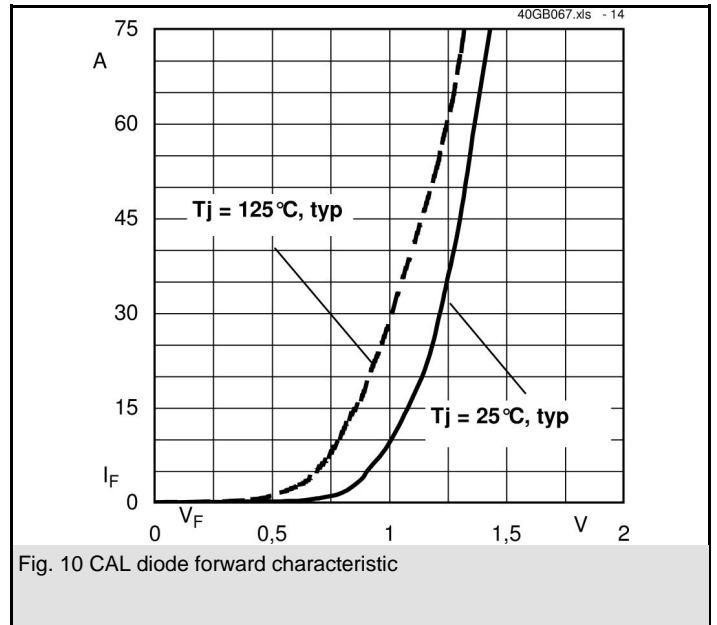
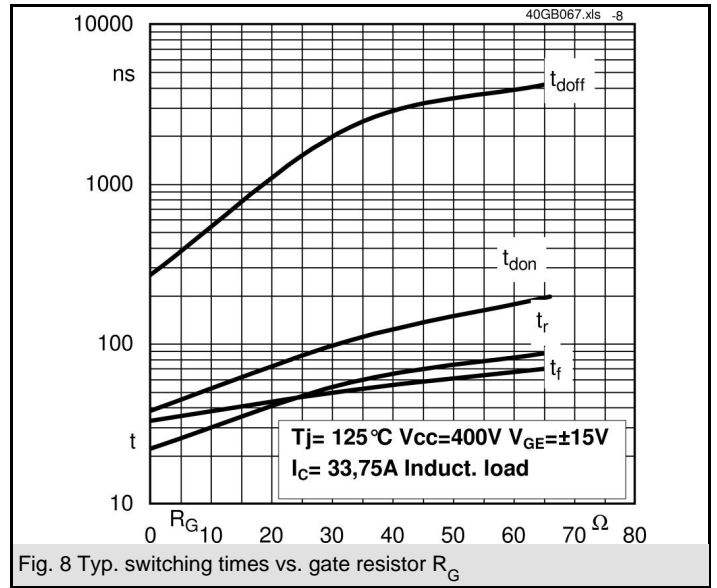
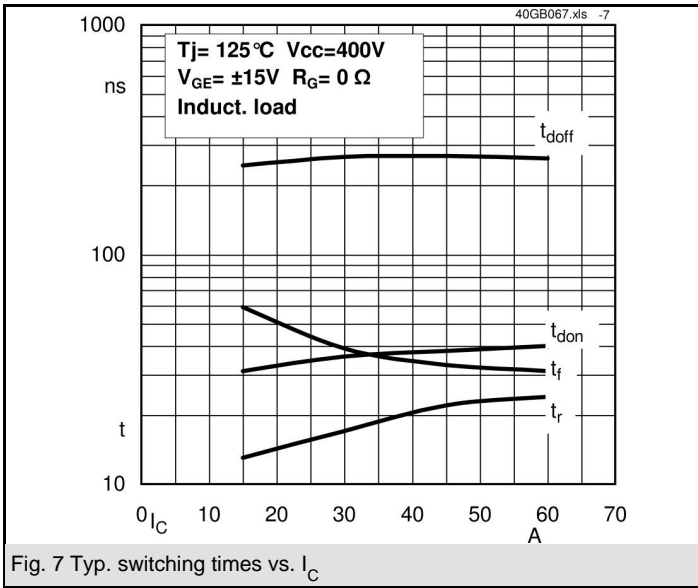

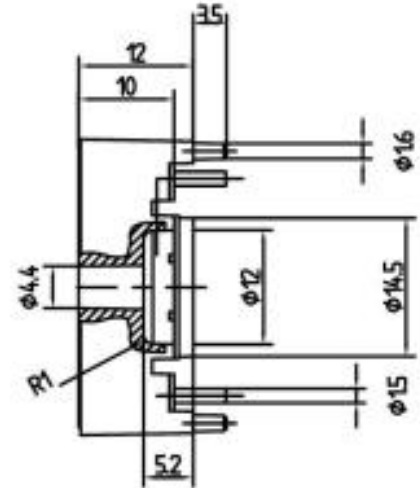
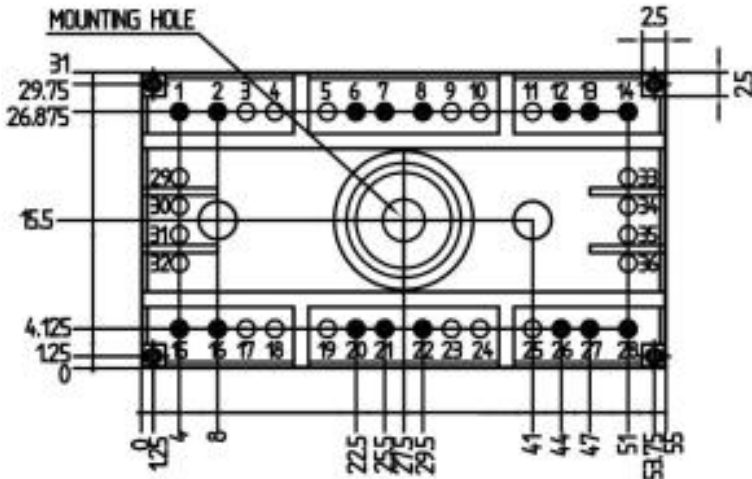
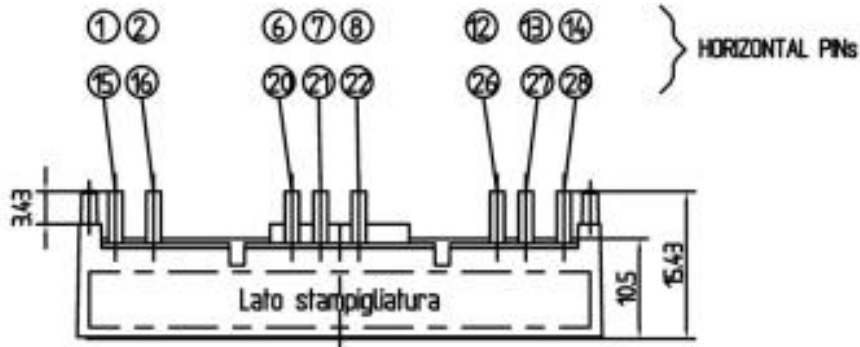

Case T66 (Suggested hole diameter, in the PCB, for solder pins and plastic mounting pins: 2mm)

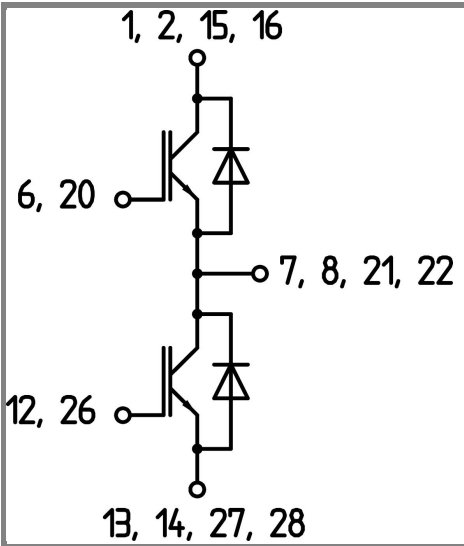

Case T 32

GB

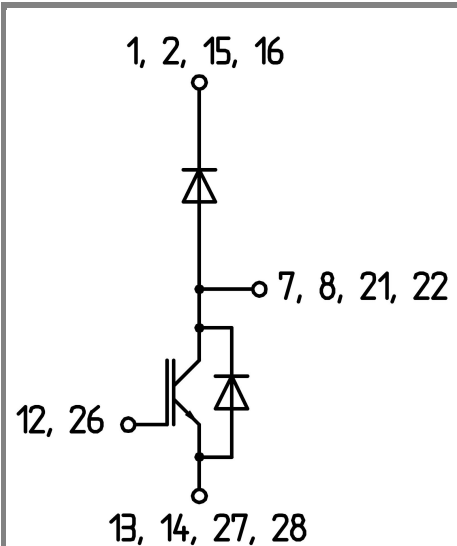

Case T 70

GAL

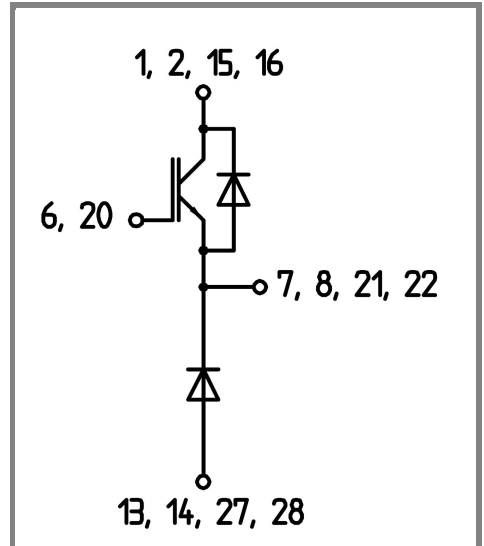

Case T 71

GAR