

SK 30 DGDL 066 ET

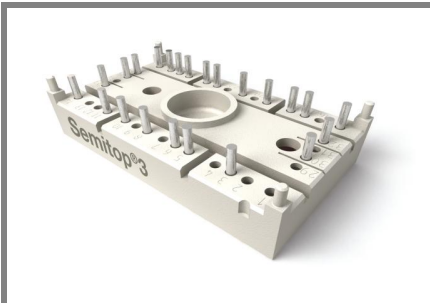

SEMITOP[®]3

**3-phase bridge rectifier +
brake chopper + 3-phase
bridge inverter**
SK 30 DGDL 066 ET

Target Data

Features

- Compact design
- One screw mounting
- Heat transfer and isolation through direct copper bonded aluminium oxide ceramic (DCB)
- Trench IGBT technology
- CAL technology FWD
- Integrated NTC temperature sensor

Typical Applications*

- Inverter up to 10 kVA
- Typ. motor power 4 kW

Remarks

- $V_{CE,sat}$, V_F = chip level value
- SC data:
 $t_p \leq 6\mu s$; $V_{GE} \leq 15V$; $T_j = 150^\circ C$; $V_{CC} = 360V$
- $V_{isol} = 3000V$ AC, 50Hz, 1s

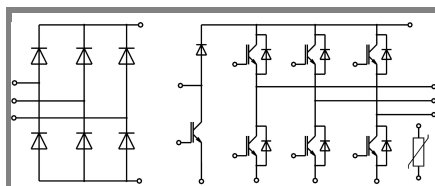

DGDL - ET

Absolute Maximum Ratings		$T_s = 25^\circ C$, unless otherwise specified	
Symbol	Conditions	Values	Units
IGBT - Inverter, chopper			
V_{CES}		600	V
I_C	$T_s = 25 (70)^\circ C, T_j = 175^\circ C$	40 (31)	A
I_C	$T_s = 25 (70)^\circ C, T_j = 150^\circ C$	35 (26)	A
I_{CRM}	$I_{CRM} = 2 \times I_{Cnom}, t_p = 1 ms$	60	A
V_{GES}		± 20	V
T_j		-40 ... + 175	$^\circ C$
Diode - Inverter, chopper			
I_F	$T_s = 25 (70)^\circ C, T_j = 150^\circ C$	32 (24)	A
I_F	$T_s = 25 (70)^\circ C, T_j = 175^\circ C$	36 (28)	A
I_{FRM}	$I_{FRM} = 2 \times I_{Fnom}, t_p = 1 ms$	60	A
Diode - Rectifier			
V_{RRM}		800	V
I_F	$T_s = 70^\circ C$	35	A
I_{FSM}	$t_p = 10 ms, \sin 180^\circ, T_j = 25^\circ C$	370	A
i^2t	$t_p = 10 ms, \sin 180^\circ, T_j = 25^\circ C$	680	A^2s
T_j		-40 ... + 175	$^\circ C$
T_{sol}	Terminals, 10 s	260	$^\circ C$
T_{stg}		-40 ... + 125	$^\circ C$
V_{isol}	AC, 1 min.	2500	V

Characteristics		$T_s = 25^\circ C$, unless otherwise specified			
Symbol	Conditions	min.	typ.	max.	Units
IGBT - Inverter, chopper					
$V_{CE(sat)}$	$I_{Cnom} = 30 A, T_j = 25 (150)^\circ C$		1,45 (1,65)	1,85 (2,05)	V
$V_{GE(th)}$	$V_{GE} = V_{CE}, I_C = 0,43 mA$	5	5,8	6,5	V
$V_{CE(TO)}$	$T_j = 25 (150)^\circ C$		0,9 (0,85)	1 (0,9)	V
r_{CE}	$T_j = 25 (150)^\circ C$		18 (27)	28 (38)	m Ω
C_{ies}	$V_{CE} = 25 V, V_{GE} = 0 V, f = 1 MHz$		1,63		nF
C_{oes}	$V_{CE} = 25 V, V_{GE} = 0 V, f = 1 MHz$		0,11		nF
C_{res}	$V_{CE} = 25 V, V_{GE} = 0 V, f = 1 MHz$		0,05		nF
$R_{th(j-s)}$	per IGBT		1,65		K/W
$t_{d(on)}$	under following conditions		15		ns
t_r	$V_{CC} = 300 V, V_{GE} = -7/+15$		12		ns
$t_{d(off)}$	$I_{Cnom} = 30 A, T_j = 125^\circ C$		228		ns
t_f	$R_{Gon} = R_{Goff} = 12 \Omega$		46		ns
$E_{on} (E_{off})$	inductive load		0,55 (1,15)		mJ
Diode - Inverter, chopper					
$V_F = V_{EC}$	$I_F = 30 A, T_j = 25 (150)^\circ C$		1,5 (1,5)	1,7 (1,7)	V
$V_{(TO)}$	$T_j = 25 (150)^\circ C$		1 (0,9)		V
r_T	$T_j = 150 ()^\circ C$		20		m Ω
$R_{th(j-s)}$	per diode		2,3		K/W
I_{RRM}	under following conditions		19,1		A
Q_{rr}	$I_{Fnom} = 30 A, V_R = 300 V$		1,8		μC
E_{rr}	$V_{GE} = 0 V, T_j = 125^\circ C$		0,53		mJ
	$di_F/dt = -950 A/\mu s$				
Diode rectifier					
V_F	$I_{Fnom} = 25 A, T_j = 25^\circ C$		1,1		V
$V_{(TO)}$	$T_j = 150^\circ C$		0,8		V
r_T	$T_j = 150^\circ C$		15		m Ω
$R_{th(j-s)}$	per diode		1,7		K/W
Temperature Sensor					
R_{ts}	5 %, $T_r = 25 (100)^\circ C$		5000(493)		Ω
Mechanical Data					
w			30		g
M_s	Mounting torque	2,25		2,5	Nm

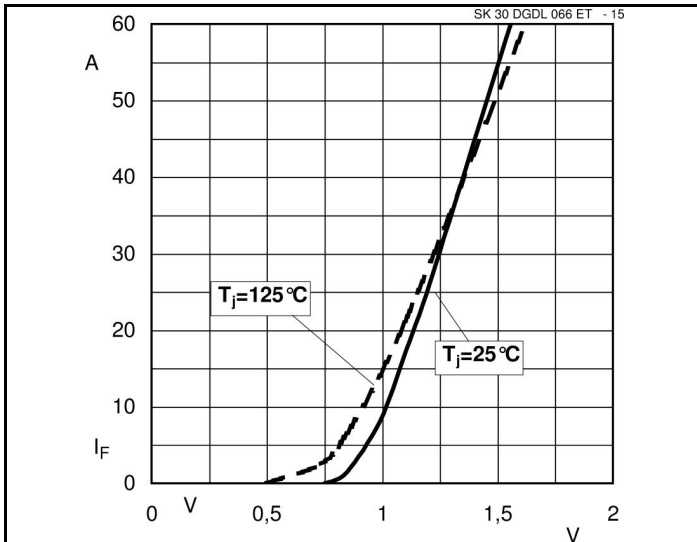

Fig. 15 Input Bridge Diode forward characteristic

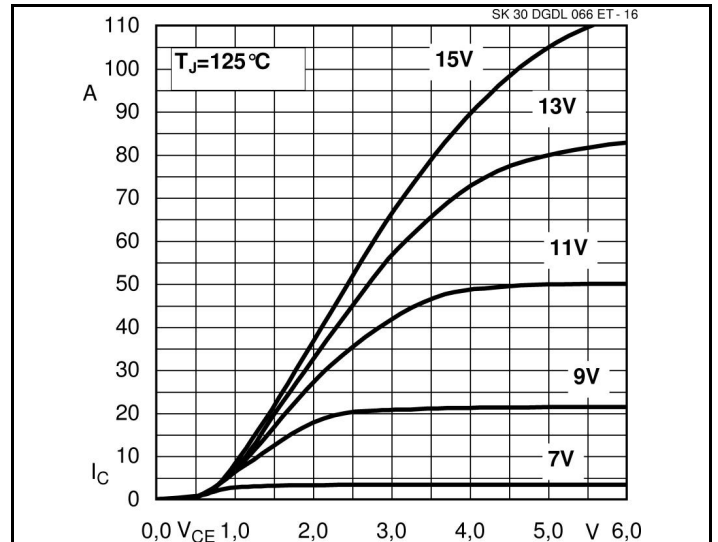

Fig. 16 Typical Output Characteristic

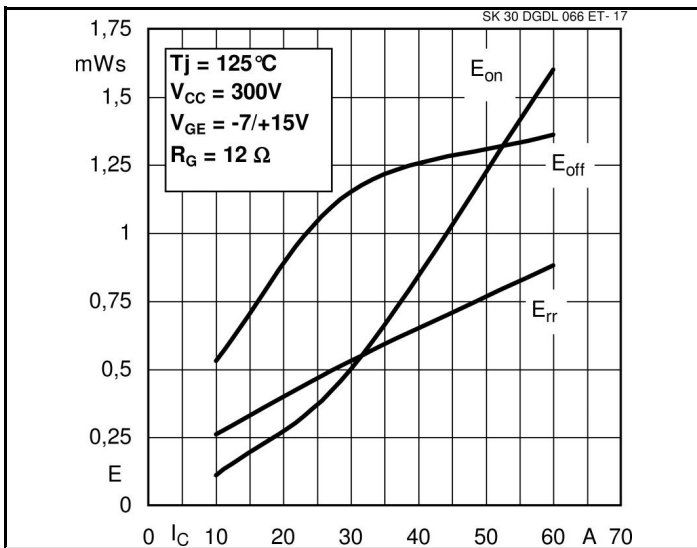

Fig. 17 Turn-on/off energy=f(I_C)

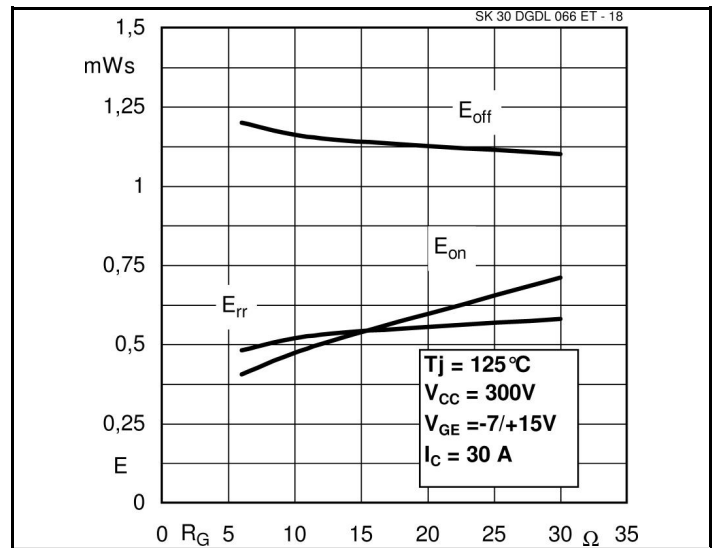

Fig. 18 Turn-on/off energy=f(R_G)

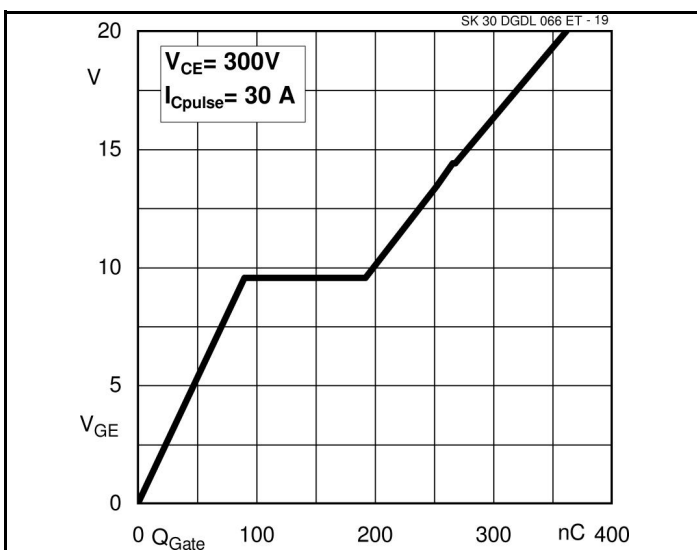
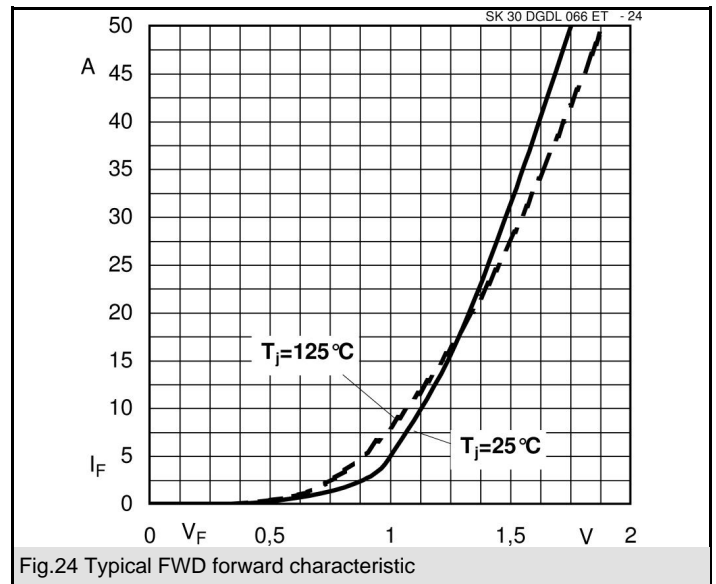
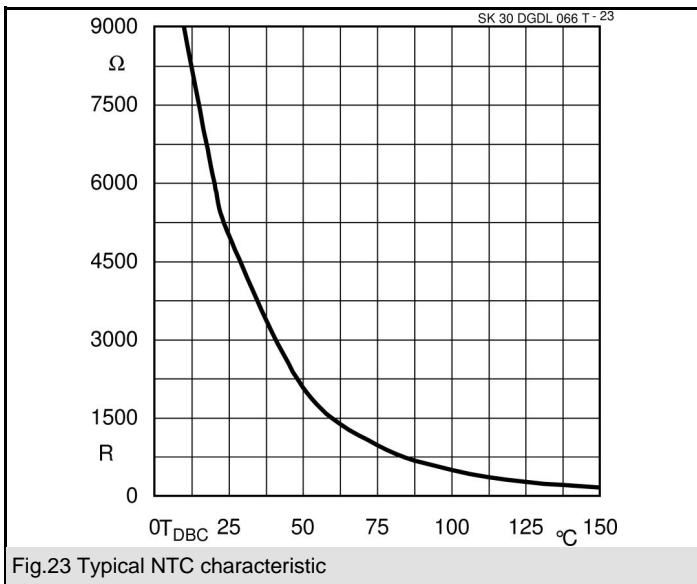
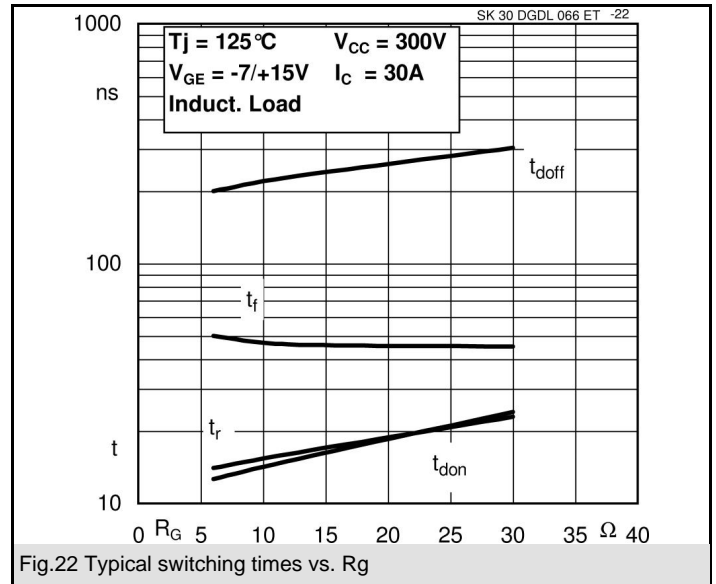
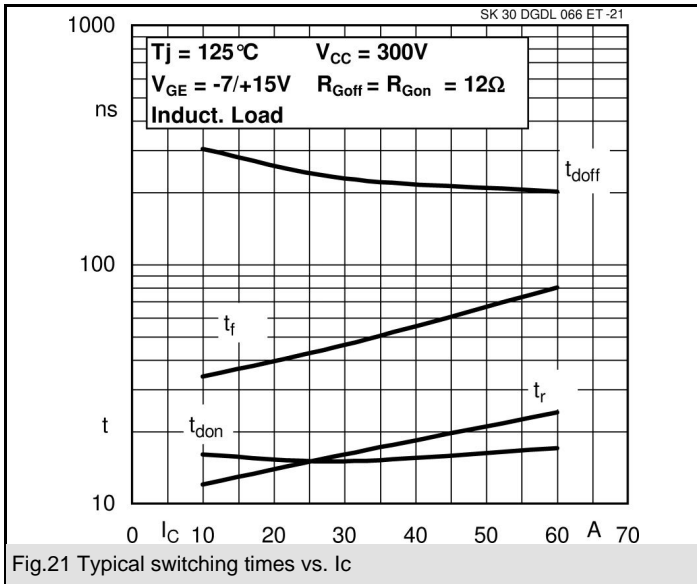
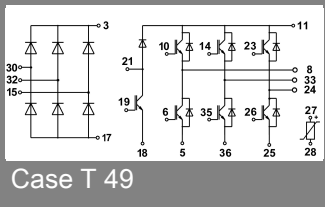

Fig. 19 Typical gate charge characteristic



SK 30 DGDL 066 ET



UL recognized
file no. E 63 532

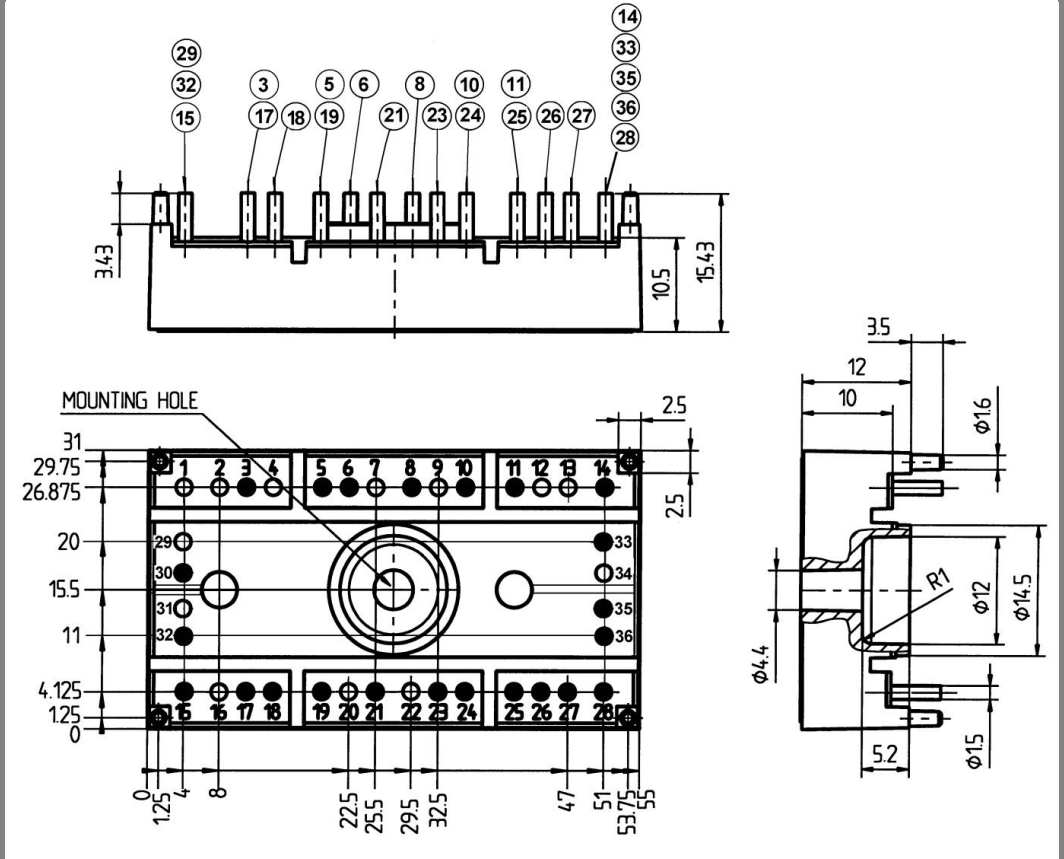

Case T 49 (Suggested hole diameter, in the PCB, for solder pins and plastic mounting pins: 2mm)

This is an electrostatic discharge sensitive device (ESDS), international standard IEC 60747-1, Chapter IX.

* The specifications of our components may not be considered as an assurance of component characteristics. Components have to be tested for the respective application. Adjustments may be necessary. The use of SEMIKRON products in life support appliances and systems is subject to prior specification and written approval by SEMIKRON. We therefore strongly recommend prior consultation of our personal.