

SKT 760



Capsule Thyristor

Line Thyristor

SKT 760

Features

- Hermetic metal case with ceramic insulator
- Capsule package for double sided cooling
- Shallow design with single sided cooling
- International standard case
- Off-state and reverse voltages up to 1800 V
- Amplifying gate

Typical Applications*

- DC motor control (e. g. for machine tools)
- Controlled rectifiers (e. g. for battery charging)
- AC controllers (e. g. for temperature control)
- Recommended snubber network e. g. for $V_{VRMS} \leq 400$ V:
 $R = 33 \Omega / 32$ W, $C = 1 \mu F$

V_{RSM} V	V_{RRM}, V_{DRM} V	$I_{TRMS} = 1600$ A (maximum value for continuous operation) $I_{TAV} = 760$ A (sin. 180; DSC; $T_c = 80$ °C)	
900	800	SKT 760/08D	
1300	1200	SKT 760/12E	
1500	1400	SKT 760/14E	
1700	1600	SKT 760/16E	
1900	1800	SKT 760/18E	

Symbol	Conditions	Values	Units
I_{TAV}	sin. 180; $T_c = 100$ (85) °C;	488 (696)	A
I_D	2 x P8/180; $T_a = 45$ °C; B2 / B6	440 / 620	A
	2 x P8/180 F; $T_a = 35$ °C; B2 / B6	1200 / 1700	A
I_{RMS}	2 x P8/180; $T_a = 45$ °C; W1C	480	A
I_{TSM}	$T_{vj} = 25$ °C; 10 ms	15000	A
	$T_{vj} = 125$ °C; 10 ms	13000	A
i^2t	$T_{vj} = 25$ °C; 8,3 ... 10 ms	1125000	A ² s
	$T_{vj} = 125$ °C; 8,3 ... 10 ms	845000	A ² s
V_T	$T_{vj} = 25$ °C; $I_T = 2400$ A	max. 1,65	V
$V_{T(TO)}$	$T_{vj} = 125$ °C	max. 0,92	V
r_T	$T_{vj} = 125$ °C	max. 0,3	mΩ
I_{DD}, I_{RD}	$T_{vj} = 125$ °C; $V_{RD} = V_{RRM}; V_{DD} = V_{DRM}$	max. 90	mA
t_{gd}	$T_{vj} = 25$ °C; $I_G = 1$ A; $di_G/dt = 1$ A/μs	1	μs
t_{gr}	$V_D = 0,67 * V_{DRM}$	2	μs
$(di/dt)_{cr}$	$T_{vj} = 125$ °C	max. 125	A/μs
$(dv/dt)_{cr}$	$T_{vj} = 125$ °C; SKT ...D / SKT ...E	max. 500 / 1000	V/μs
t_q	$T_{vj} = 125$ °C,	100 ... 200	μs
I_H	$T_{vj} = 25$ °C; typ. / max.	150 / 500	mA
I_L	$T_{vj} = 25$ °C; typ. / max.	500 / 2000	mA
V_{GT}	$T_{vj} = 25$ °C; d.c.	min. 3	V
I_{GT}	$T_{vj} = 25$ °C; d.c.	min. 200	mA
V_{GD}	$T_{vj} = 125$ °C; d.c.	max. 0,25	V
I_{GD}	$T_{vj} = 125$ °C; d.c.	max. 10	mA
$R_{th(j-c)}$	cont.; DSC	0,038	K/W
$R_{th(j-c)}$	sin. 180; DSC / SSC	0,04 / 0,082	K/W
$R_{th(j-c)}$	rec. 120; DSC / SSC	0,045 / 0,093	K/W
$R_{th(c-s)}$	DSC / SSC	0,007 / 0,014	K/W
T_{vj}		- 40 ... + 125	°C
T_{stg}		- 40 ... + 130	°C
V_{isol}		-	V~
F	mounting force	10 ... 13	kN
a			m/s ²
m	approx.	240	g
Case		B 10	



SKT

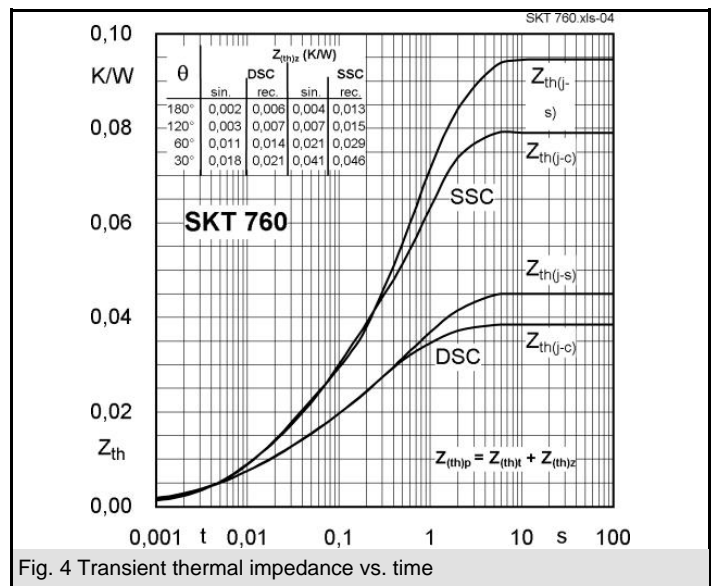
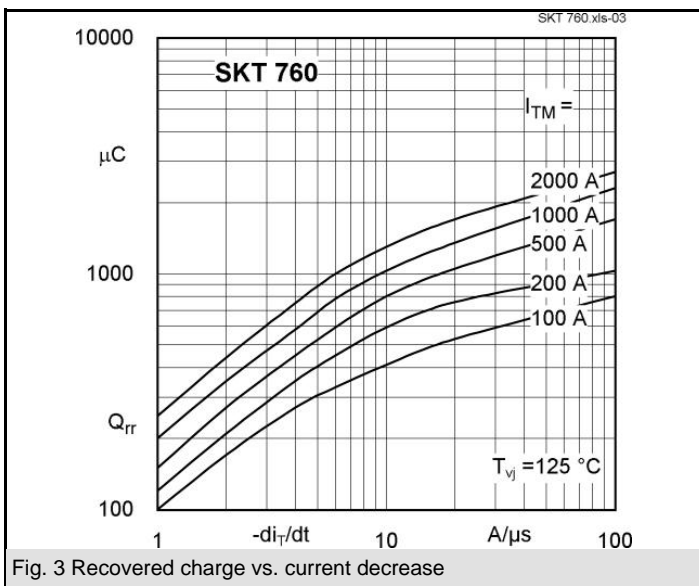
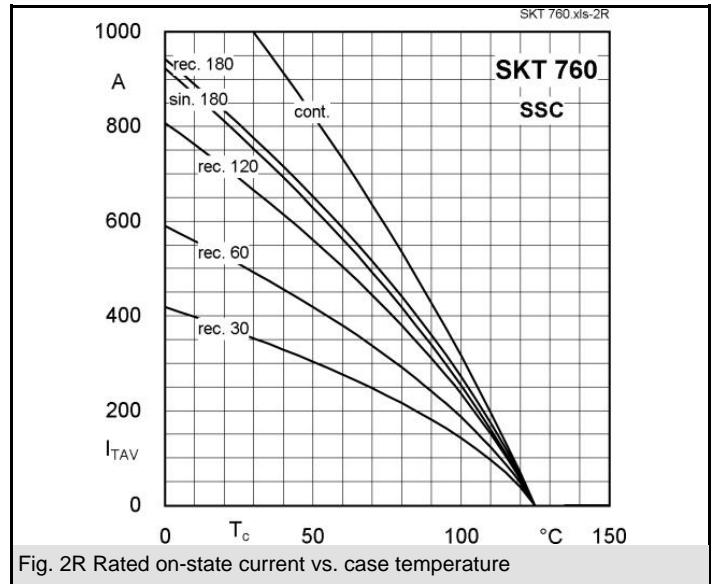
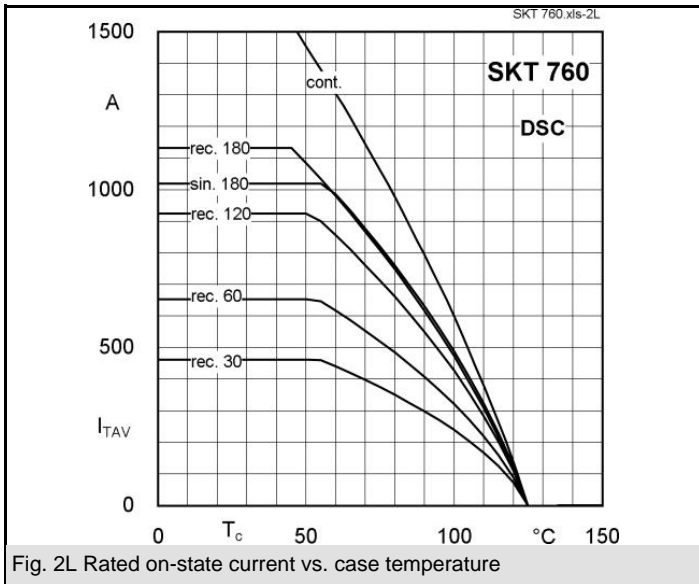
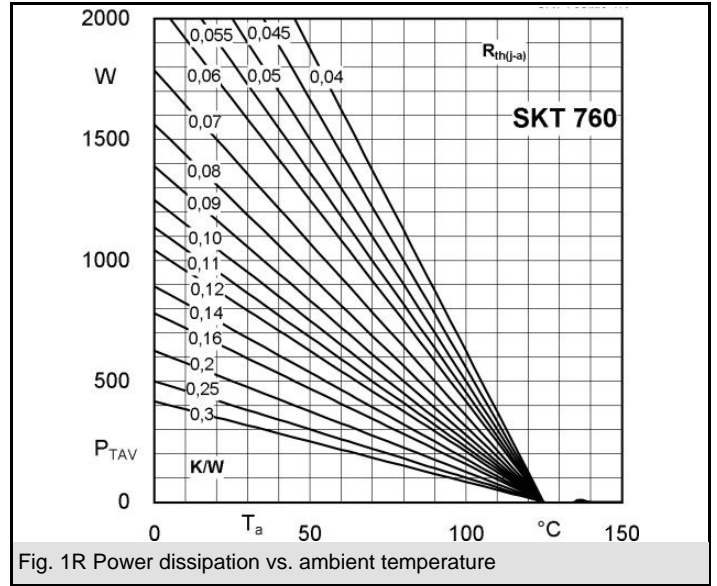
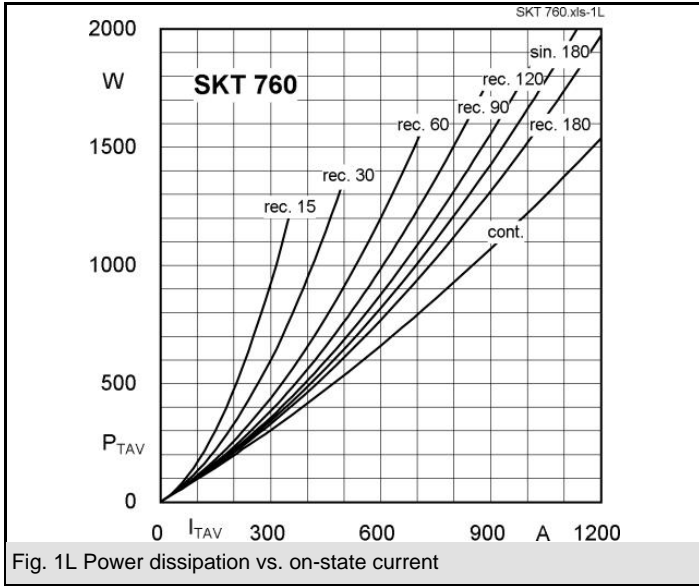

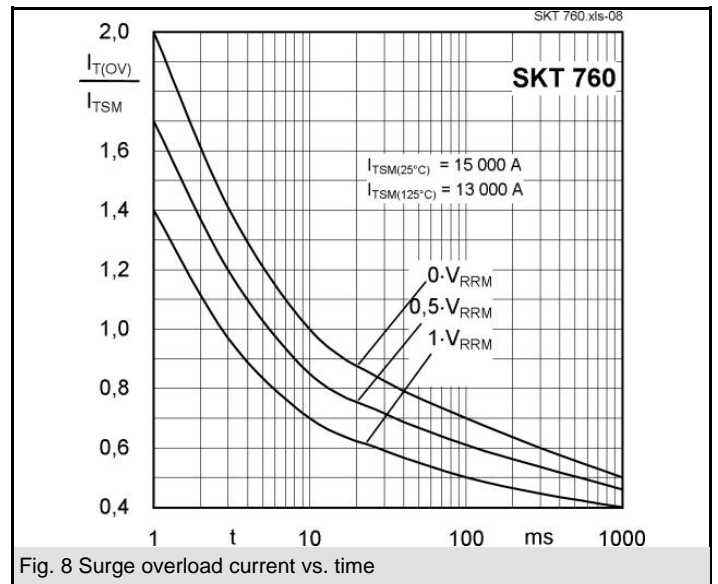
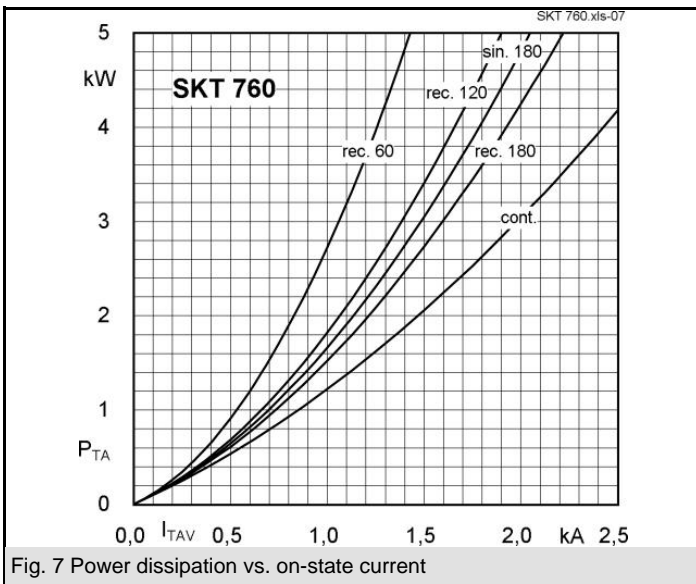
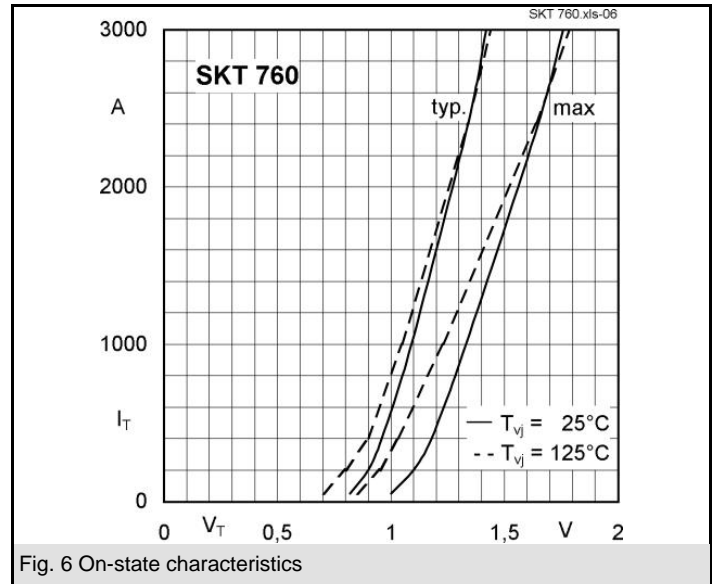
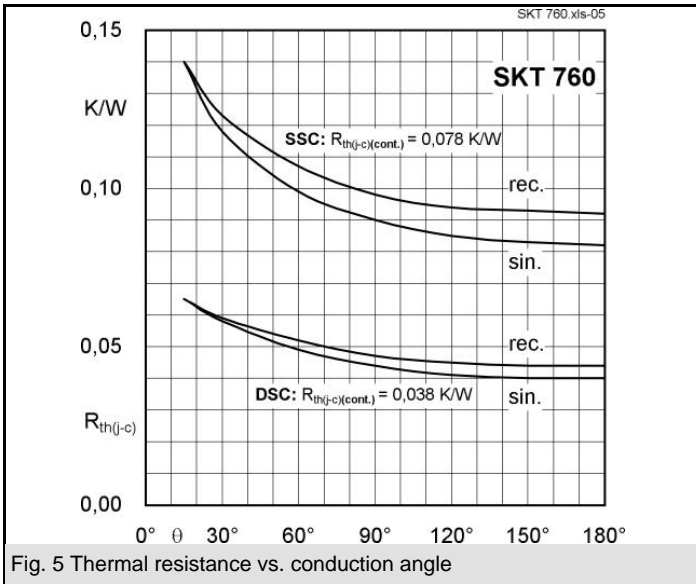

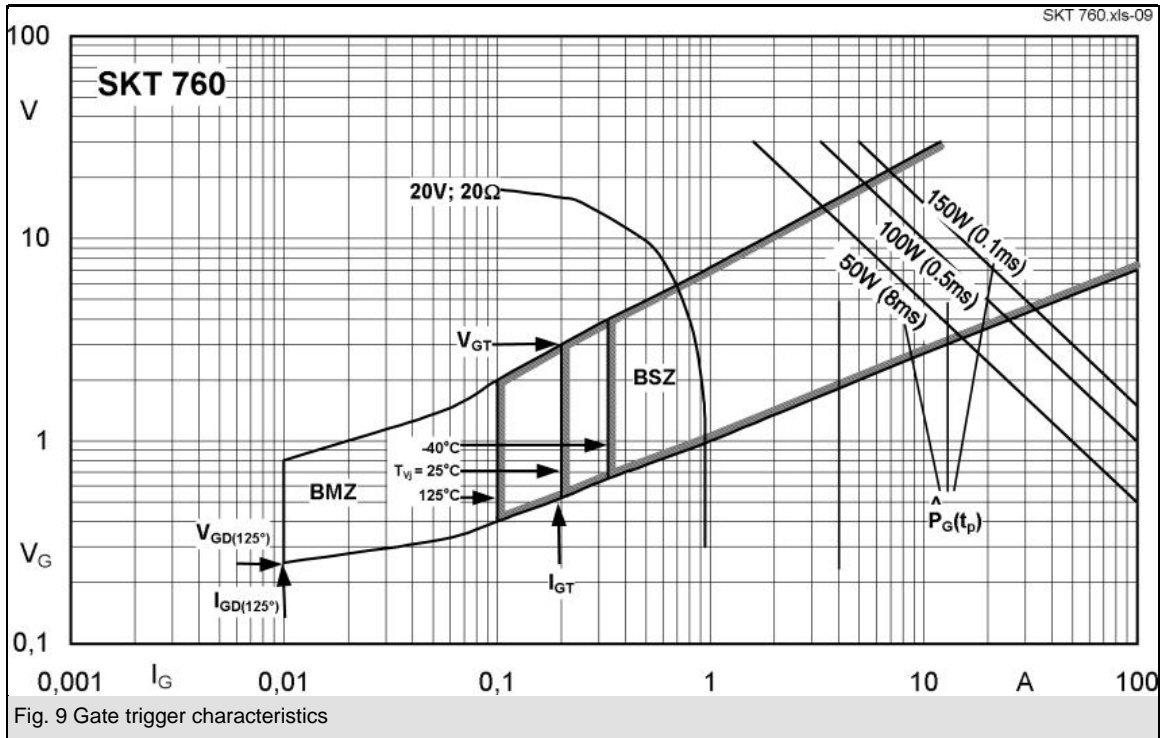
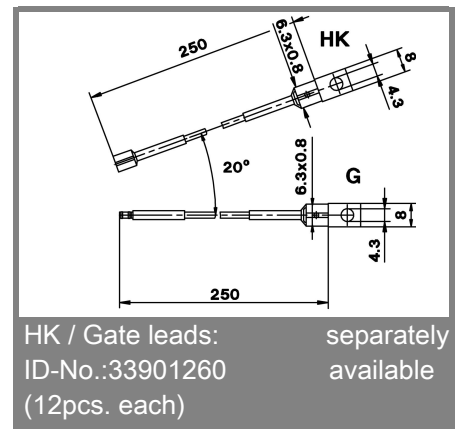
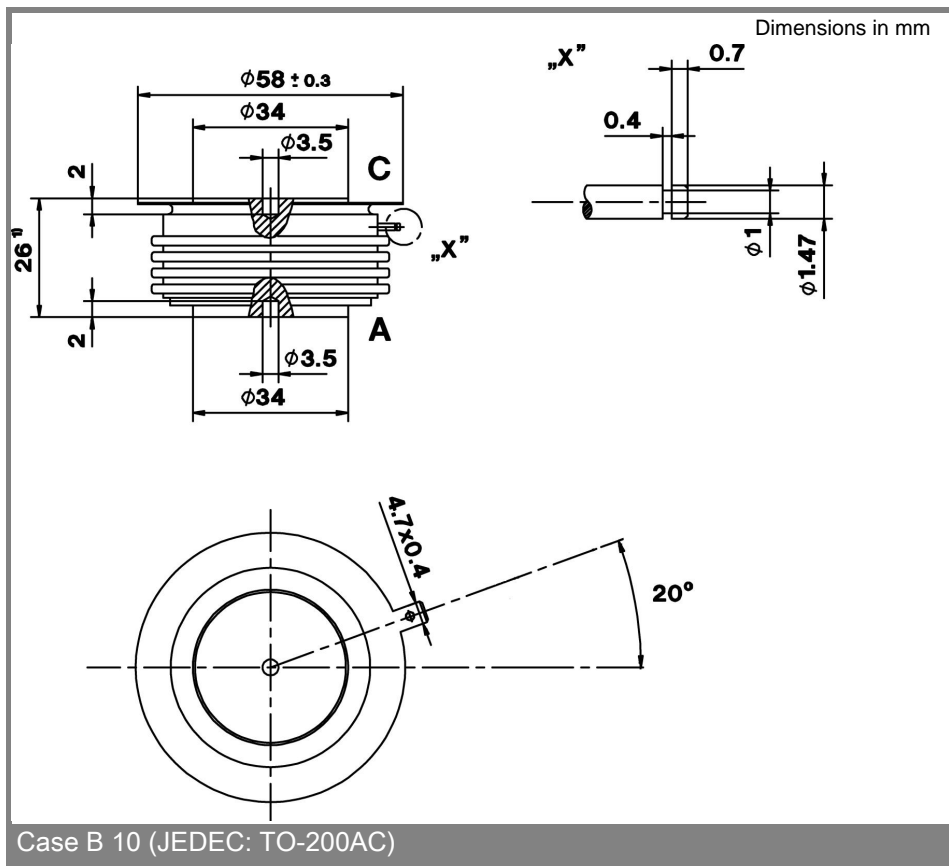

Fig. 9 Gate trigger characteristics



* The specifications of our components may not be considered as an assurance of component characteristics. Components have to be tested for the respective application. Adjustments may be necessary. The use of SEMIKRON products in life support appliances and systems is subject to prior specification and written approval by SEMIKRON. We therefore strongly recommend prior consultation of our personal.