

V_{RSM}	V_{RRM} V_{DRM}	$(dv/dt)_{cr}$	I_{TRMS} (maximum values for continuous operation)		
			30 A	40 A	50 A
V	V	V/ μ s	I_{TAV} (sin. 180; $T_{case} = \dots$ °C)		
			19 A (95 °C)	25 A (74 °C)	32 A (72 °C)
500	400	500	–	SKT 16/04 D	SKT 24/04 D
700	600	500	SKT 10/06 D	SKT 16/06 D*	–
900	800	500	SKT 10/08 D	SKT 16/08 D	SKT 24/08 D
1300	1200	1000	SKT 10/12 E	SKT 16/12 E*	SKT 24/12 E*
1500	1400	1000	–	SKT 16/14 E	SKT 24/14 E
1700	1600	1000	–	SKT 16/16 E	SKT 24/16 E*
1900	1800	1000	–	SKT 16/18 E♦	SKT 24/18 E♦

Thyristors

SKT 10
SKT 16
SKT 24



Symbol	Conditions	SKT 10	SKT 16	SKT 24	Units
I_{TAV}	sin. 180; ($T_{case} = \dots$)	10 (106)	16 (103)	24 (94)	A °C
I_{TSM}	$T_{vj} = 25$ °C; 10 ms $T_{vj} = 130$ °C; 10 ms	250 210	370 330	450 380	A A
i^2t	$T_{vj} = 25$ °C; 8,35 ... 10 ms $T_{vj} = 130$ °C; 8,35 ... 10 ms	310 220	680 550	1000 720	A ² s A ² s
t_{gd}	$T_{vj} = 25$ °C $I_G = 1$ A $di_G/dt = 1$ A/ μ s	typ. 1			μ s
t_{gr}	$V_D = 0,67 \cdot V_{DRM}$	typ. 2			μ s
$(di/dt)_{cr}$	$f = 50 \dots 60$ Hz	50			A/ μ s
I_H	$T_{vj} = 25$ °C; typ./max.	80 / 150			mA
I_L	$T_{vj} = 25$ °C; typ./max.	150 / 300			mA
t_q	$T_{vj} = 130$ °C; typ.	80			μ s
V_T	$T_{vj} = 25$ °C; ($I_T = \dots$); max.	1,6 (30)	2,4 (75)	1,9 (75)	V A
$V_{T(TO)}$	$T_{vj} = 130$ °C	1,0	1,0	1,0	V
r_T	$T_{vj} = 130$ °C	18	20	10	m Ω
I_{DD} ; I_{RD}	$T_{vj} = 130$ °C; $V_{RD} = V_{RRM}$ $V_{DD} = V_{DRM}$	4	8	8	mA
V_{GT}	$T_{vj} = 25$ °C	3			V
I_{GT}	$T_{vj} = 25$ °C	100			mA
V_{GD}	$T_{vj} = 130$ °C	0,25			V
I_{GD}	$T_{vj} = 130$ °C	3			mA
R_{thjc}	cont. sin. 180 / rec. 120	1,2 1,3 / 1,35	0,8 0,9 / 0,95		°C/W °C/W
R_{thch}		1,0	0,5		°C/W
T_{vj}		– 40 ... + 130			°C
T_{stg}		– 40 ... + 150			°C
M	SI units US units	2,0 18	2,5 22		Nm lb. in.
a		5 · 9,81	5 · 9,81		m/s ²
w		7	12		g
Case		B 1	B 2		

* Available with UNF thread 1/4-28 UNF2A, e.g. SKT 16/06 D UNF

♦ Available in limited quantities

Features

- Hermetic metal cases with glass insulators
- Threaded studs ISO M5 and M6 or UNF 1/4-28
- International standard cases

Typical Applications

- DC motor control (e. g. for machine tools)
- Controlled rectifiers (e. g. for battery charging)
- AC controllers (e. g. for temperature control)

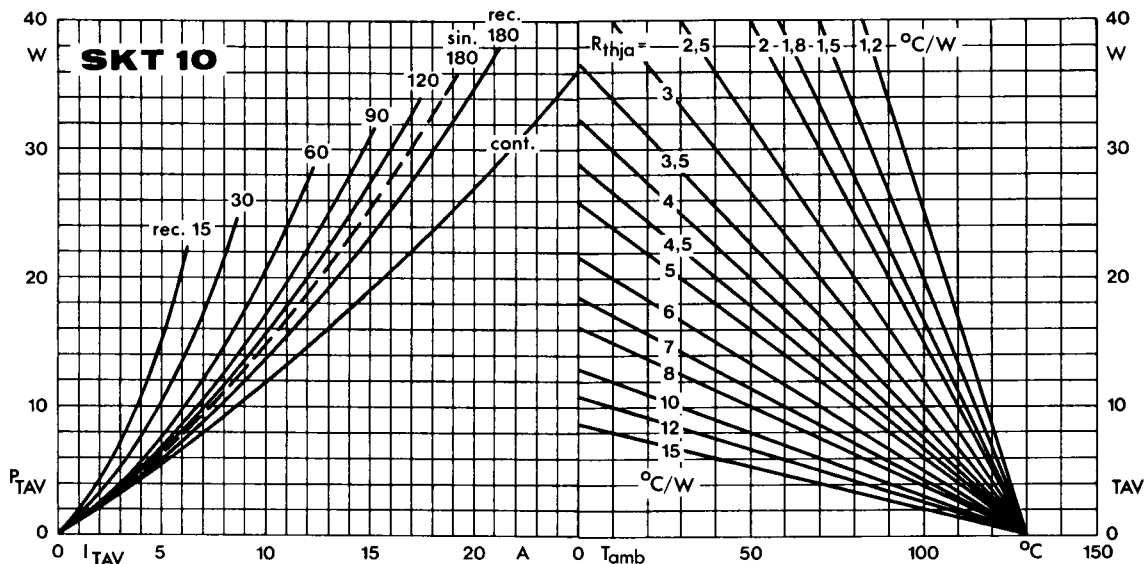

Fig. 1 a Power dissipation vs. on-state current and ambient temperature

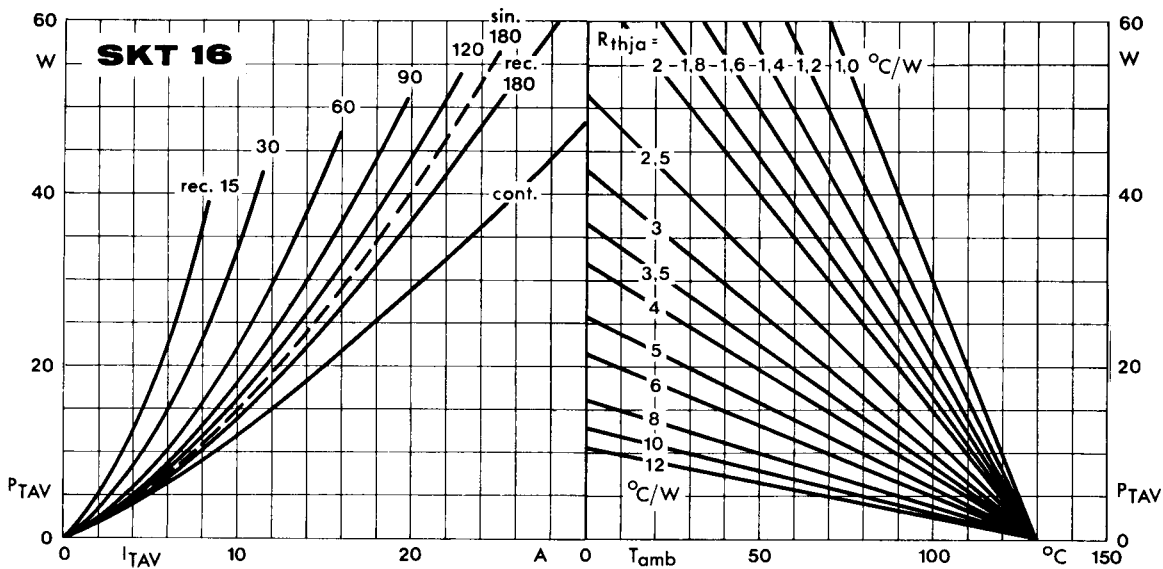

Fig. 1 b Power dissipation vs. on-state current and ambient temperature

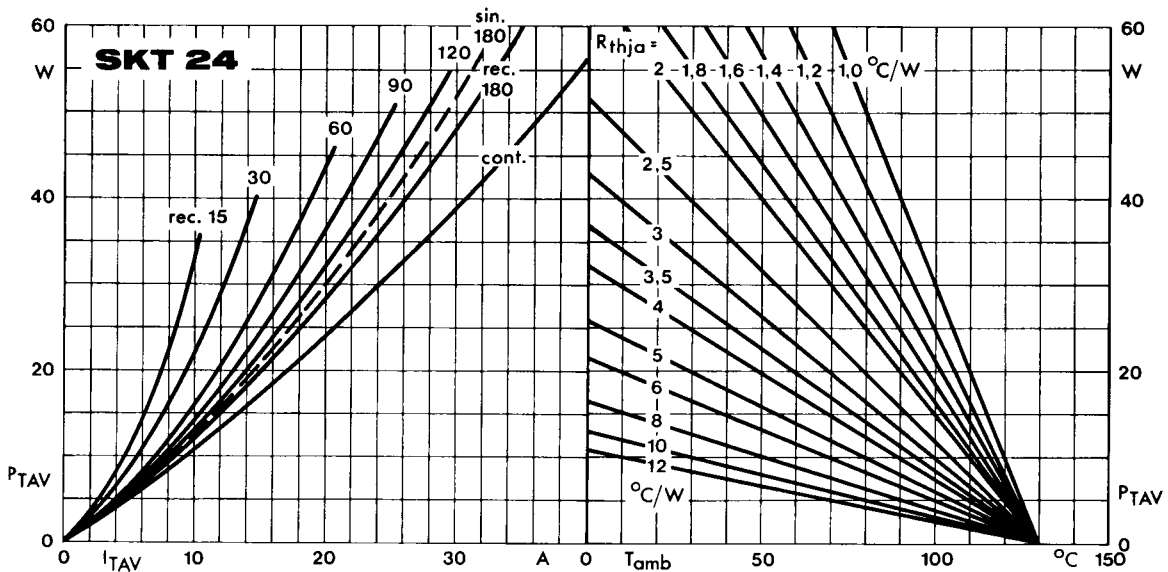

Fig. 1 c Power dissipation vs. on-state current and ambient temperature

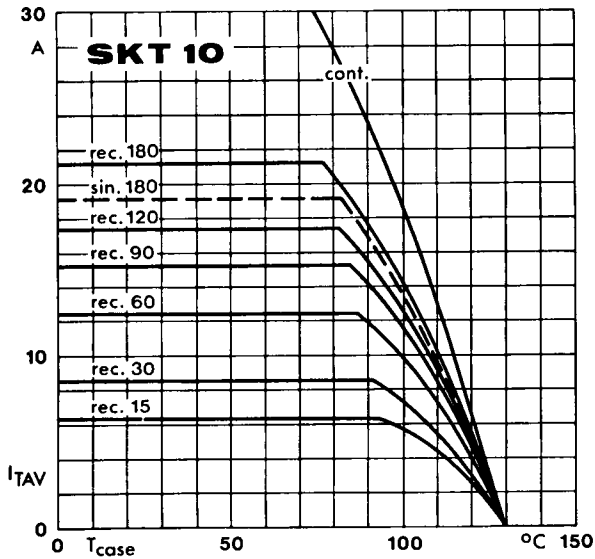

Fig. 2 a Rated on-state current vs. case temperature

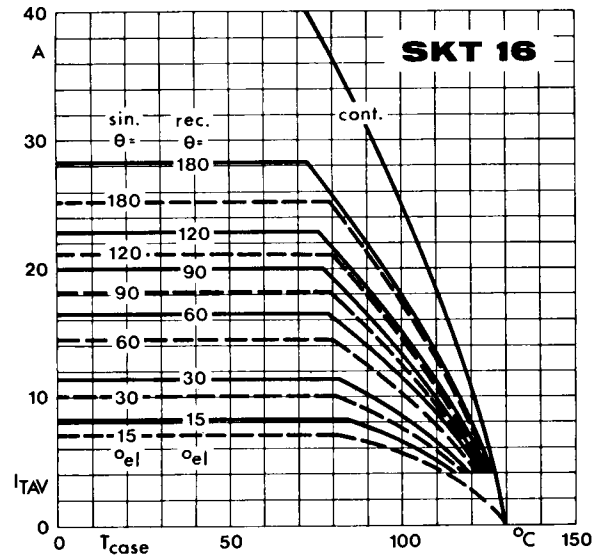

Fig. 2 b Rated on-state current vs. case temperature

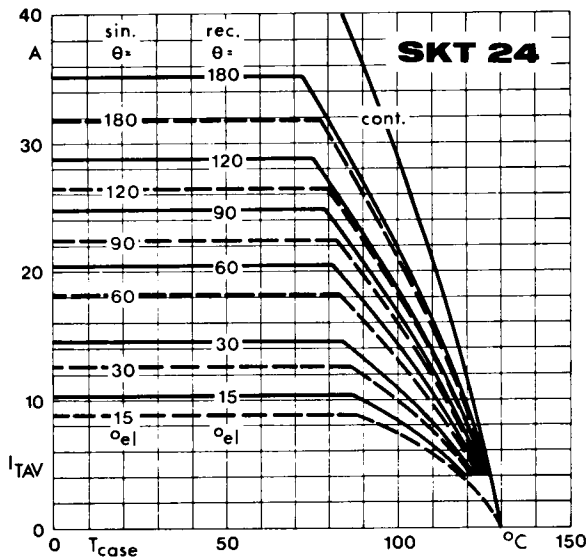

Fig. 2 c Rated on-state current vs. case temperature

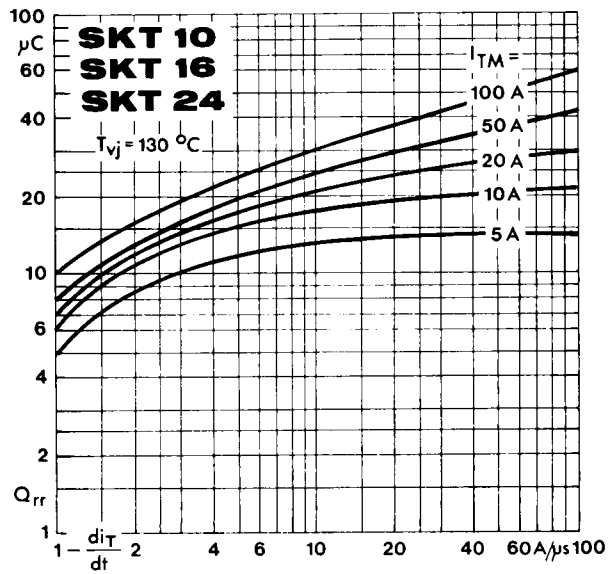

Fig. 3 Recovered charge vs. current decrease

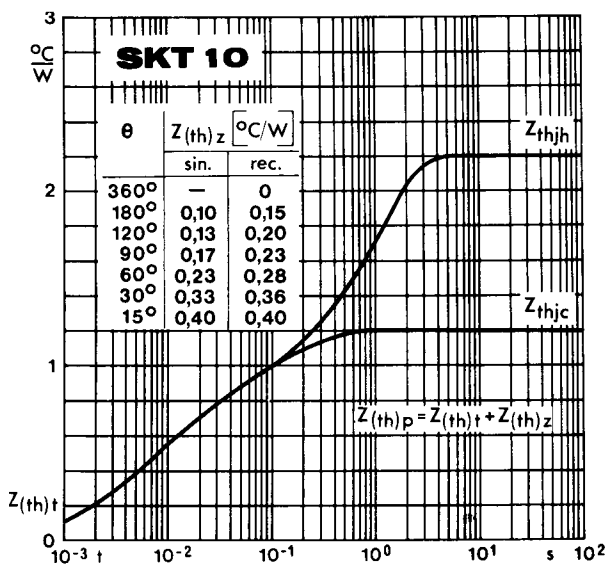

Fig. 4 a Transient thermal impedance vs. time

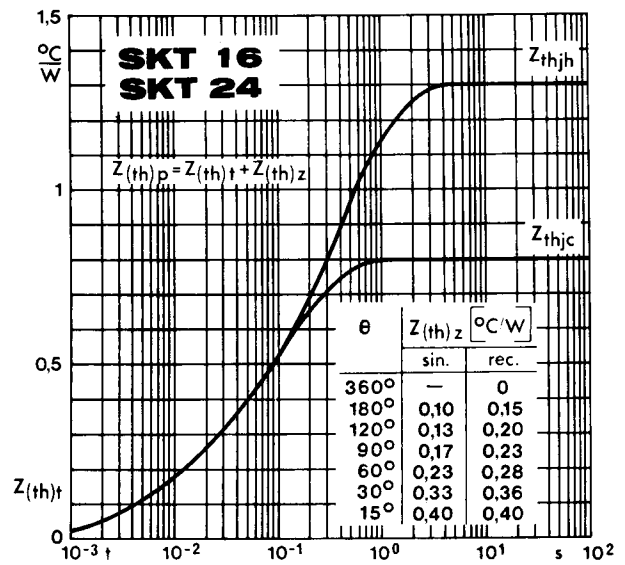

Fig. 4 b

Fig. 4 b Transient thermal impedance vs. time

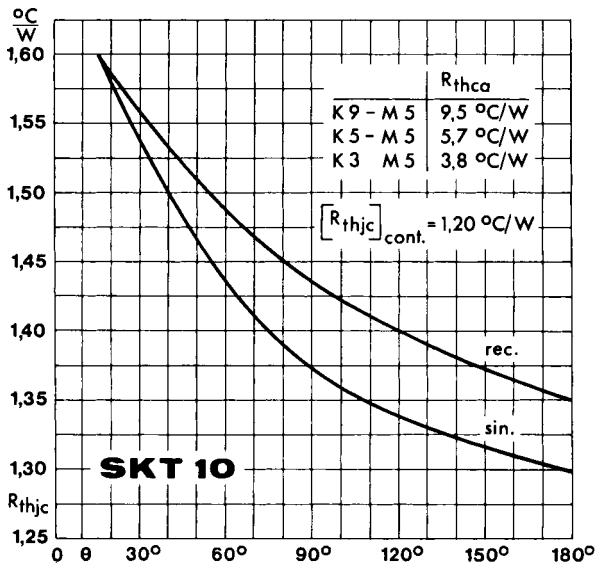

Fig. 5 a Thermal resistance vs. conduction angle

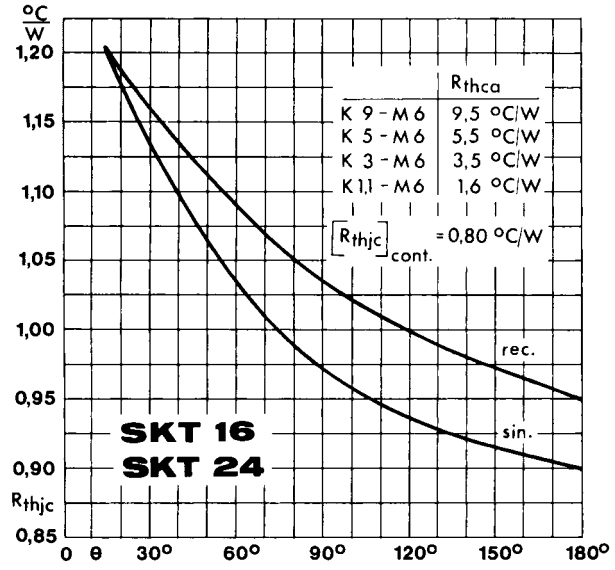

Fig. 5 b Thermal resistance vs. conduction angle

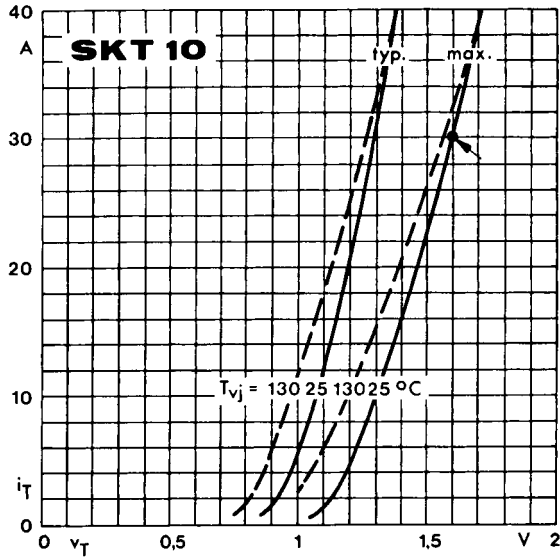

Fig. 6 a On-state characteristics

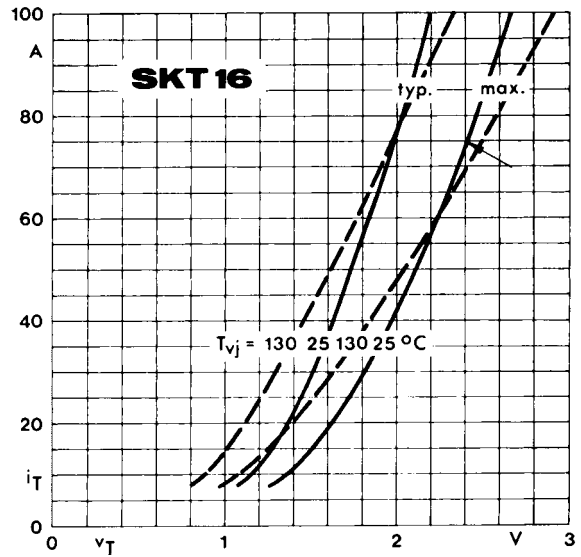

Fig. 6 b On-state characteristics

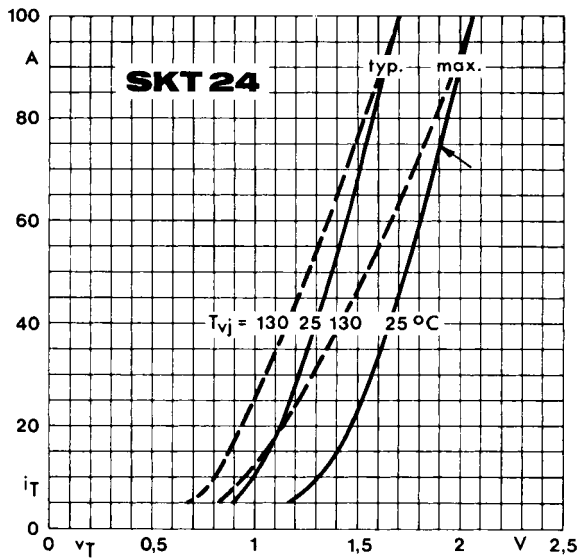

Fig. 6 c On-state characteristics

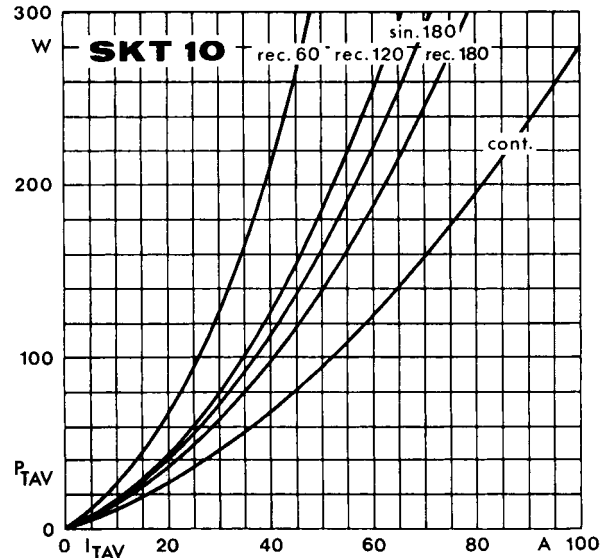

Fig. 7 a Power dissipation vs. on-state current

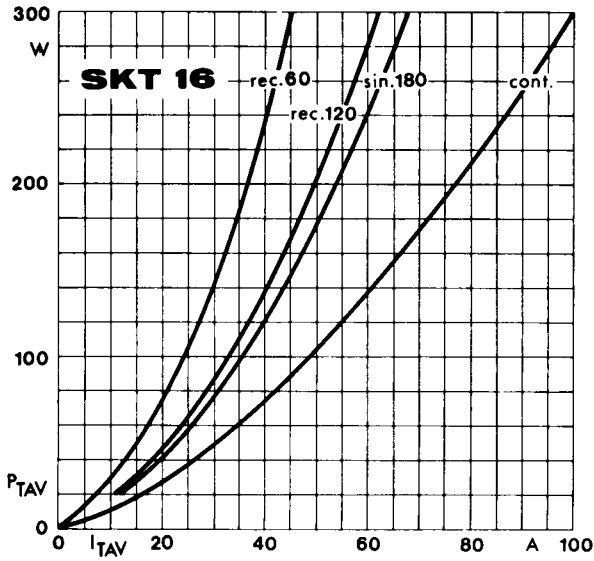

Fig. 7 b Power dissipation vs. on-state current

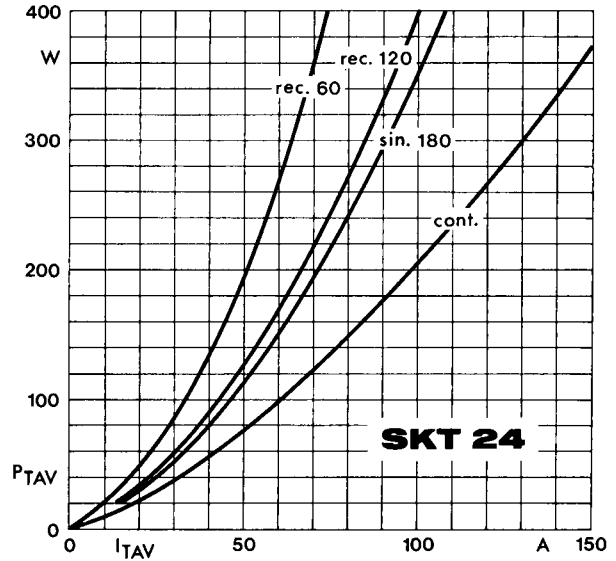

Fig. 7 c Power dissipation vs. on-state current

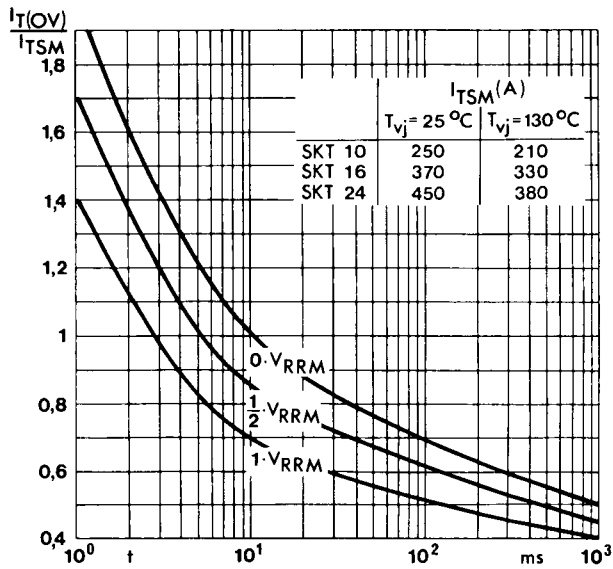

Fig. 8 Surge overload current vs. time

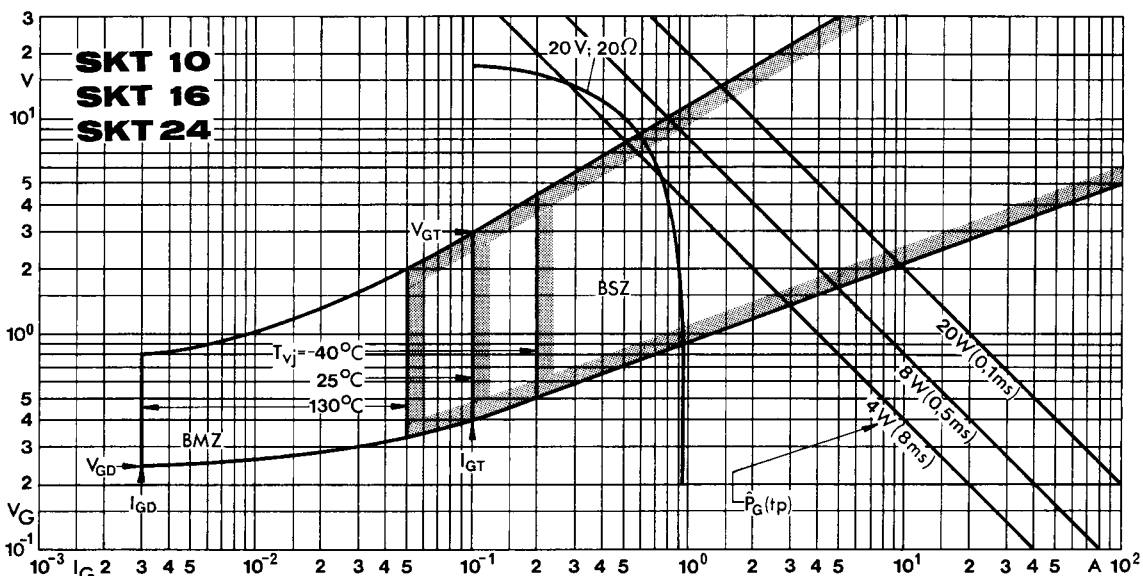

Fig. 9 Gate trigger characteristics

SKT 10

Case B 1

IEC-Publ. 191-2: A 13 M

DIN 41891: 200 B 3

BS 3934: SO-35 A

JEDEC: TO-208 AB (TO-64) metric

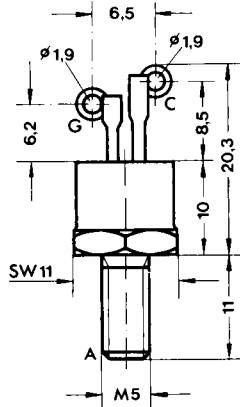
**SKT 16
SKT 24**

Case B 2

IEC-Publ. 191-2: A 11 M, A 11 U

DIN 41892: 201 C 3

BS 3934: SO-36

JEDEC: TO-208 AA (TO-48)

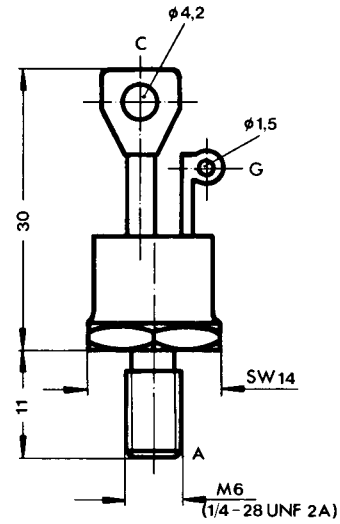
**SKT 40
SKT 50**

Case B 3

IEC-Publ. 191-2: A 38 MA, A 14 U

DIN 41892: 202 C 3

BS 3934: SO-28

JEDEC: TO-208 AC (TO-65)

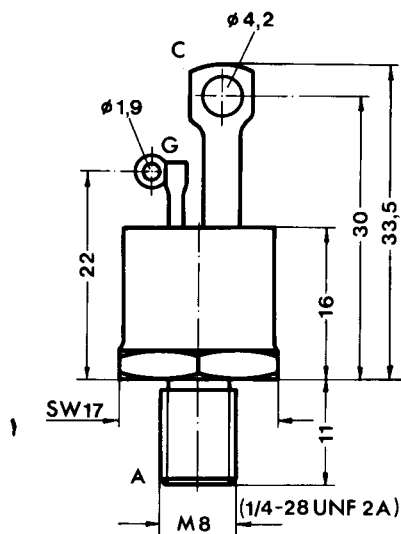

C: Cathode terminal
A: Anode terminal
G: Gate terminal

Dimensions in mm