



## Stud Diode

## Avalanche Diode

### SKNa 22

#### Publish Data

#### Features

- Avalanche type reverse characteristic
- Reverse voltages up to 5000 V
- Hermetic metal case with ceramic insulator and extra long creepage distances
- Threaded stud ISO M6
- Cooling via heatsinks
- SKN: Anode to stud

#### Typical Applications

- High voltage rectifier diode for heavy duty applications
- Series connections for high voltage equipments like dust precipitators and high voltage power supplies
- Non-controllable and half-controllable rectifiers
- Free-wheeling diodes

$V_{(BR)min}$ V	$I_{FRMS} = 40$ A (maximum value for continuous operation) $I_{FAV} = 25$ A (sin. 180; $T_c = 104$ °C)	$C_{max}$ μF	$R_{min}$ Ω
3600	SKNa 22/36		
4000	SKNa 22/40		
4200	SKNa 22/42		
4500	SKNa 22/45		
4600	SKNa 22/46		
4800	SKNa 22/48		
5000	SKNa 22/50		

Symbol	Conditions	Values	Units
$I_{FAV}$	sin. 180 ; $T_c = 104$ (120) °C	25 (20)	A
$I_D$	K 9; $T_a = 45$ °C; B2 / B6	16 / 23	A
	K 3; $T_a = 45$ °C; B2 / B6	28 / 40	A
$I_{FSM}$	$T_{vj} = 25$ °C; 10 ms	450	A
	$T_{vj} = 160$ °C; 10 ms	375	A
$i^2t$	$T_{vj} = 25$ °C; 8,3 ... 10 ms	1000	A <sup>2</sup> s
	$T_{vj} = 160$ °C; 8,3 ... 10 ms	700	A <sup>2</sup> s
$V_F$	$T_{vj} = 25$ °C; $I_F = 60$ A	max. 1,95	V
$V_{(TO)}$	$T_{vj} = 150$ °C	max. 1	V
$r_T$	$T_{vj} = 150$ °C	max. 20	mΩ
$I_{RD}$	$T_{vj} = 25$ °C; $V_{RD} = V_{(BR)min}$	max. 300	μA
	$T_{vj} = 160$ °C; $V_{RD} = V_{(BR)min}$	max. 3	mA
$P_{RSM}$	$T_{vj} = 160$ °C; $t_p = 10$ μs	10	kW
$R_{th(j-c)}$		1	K/W
$R_{th(c-s)}$		1	K/W
$T_{vj}$		- 40 ... + 160	°C
$T_{stg}$		- 40 ... + 160	°C
$V_{isol}$		-	V~
$M_s$	to heatsink	2	Nm
		18	lb.in.
a		5 * 9,81	m/s <sup>2</sup>
m	approx.	25	g
Case		E 42	

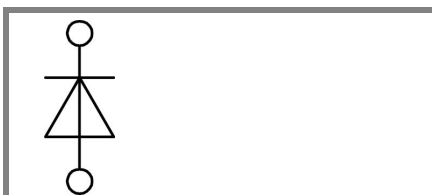

SKN

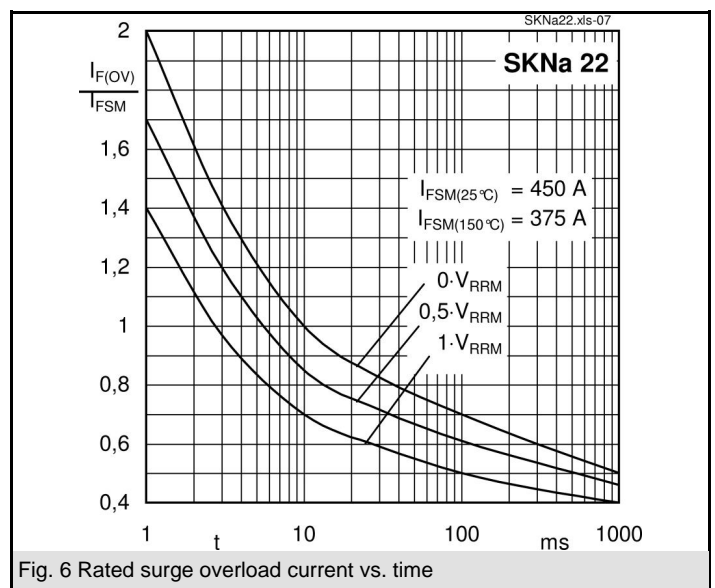
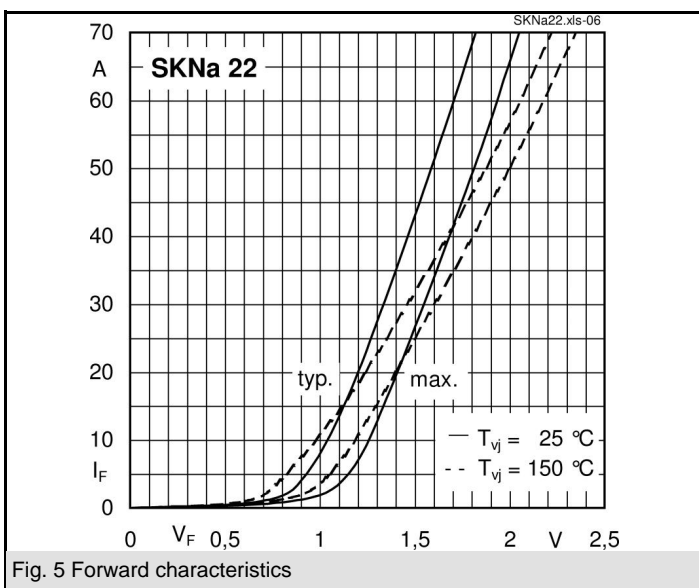
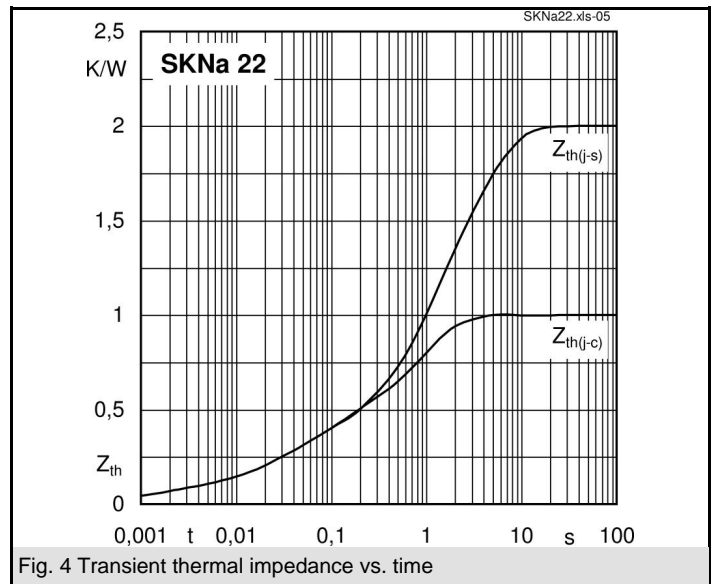
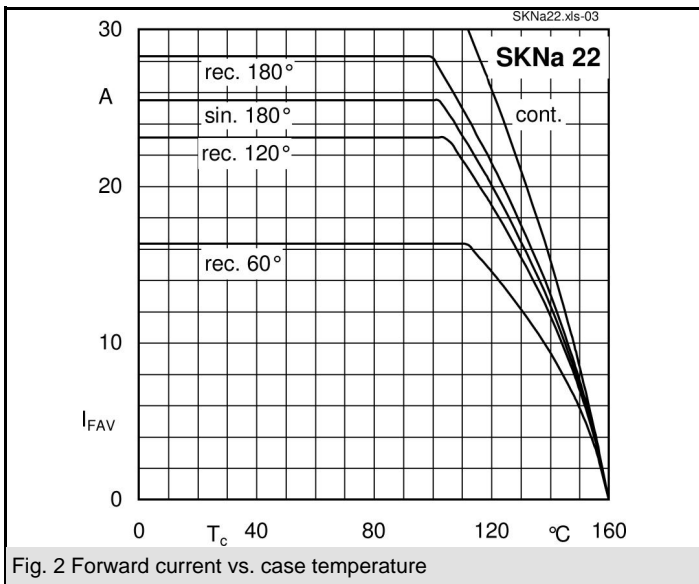
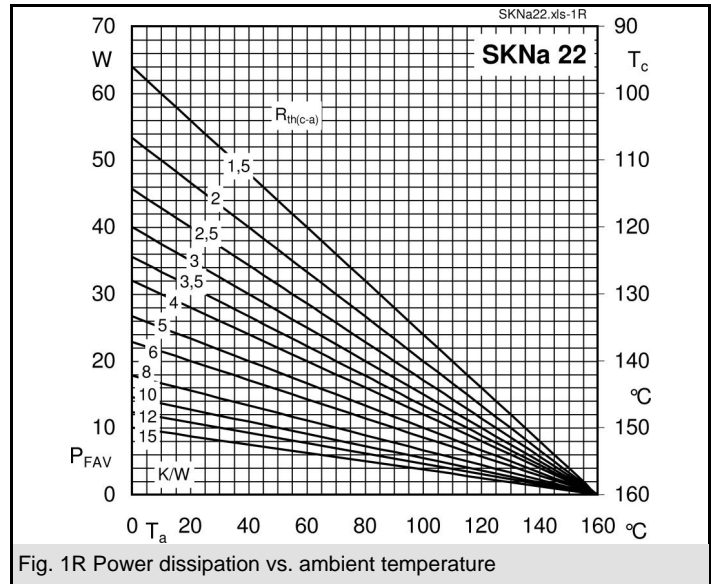
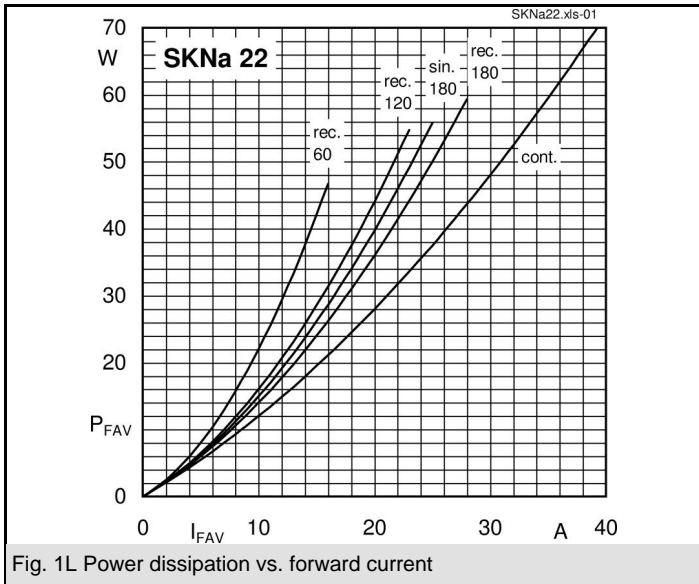

Dimensions in mm

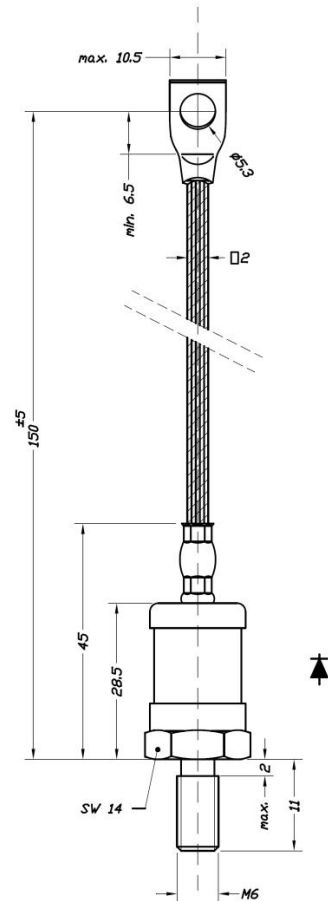

CASE E 42 (IEC 60191: A 16 M modified)

This technical information specifies semiconductor devices but promises no characteristics. No warranty or guarantee expressed or implied is made regarding delivery, performance or suitability.