



Stud Diode

Avalanche Diode

SKNa 202

Publish Data

Features

- Avalanche type reverse characteristic
- Reverse voltages up to 5000 V
- Hermetic metal case with ceramic insulator and extra long creepage distances
- Threaded stud ISO M16 x 1,5
- Cooling via heatsinks
- SKN: Anode to stud

Typical Applications

- High voltage rectifier diode for traction and heavy duty applications
- Series connections for high voltage applications
- Non-controllable and half-controllable rectifiers
- Free-wheeling diodes

$V_{(BR)min}$	$I_{FRMS} = 500 \text{ A}$ (maximum value for continuous operation)	C_{max}	R_{min}
V	$I_{FAV} = 200 \text{ A}$ (sin. 180; $T_c = 80 \text{ }^\circ\text{C}$)	μF	Ω
3600	SKNa 202/36		
4000	SKNa 202/40		
4200	SKNa 202/42		
4500	SKNa 202/45		
4600	SKNa 202/46		
4800	SKNa 202/48		
5000	SKNa 202/50		

Symbol	Conditions	Values	Units
I_{FAV}	sin. 180 ; $T_c = 80$ (100) $^\circ\text{C}$	200 (165)	A
I_D	K 0,55; $T_a = 45 \text{ }^\circ\text{C}$; B2 / B6	208 / 296	A
	K 0,55F; $T_a = 35 \text{ }^\circ\text{C}$; B2 / B6	340 / 478	A
I_{FSM}	$T_{vj} = 25 \text{ }^\circ\text{C}$; 10 ms	3800	A
	$T_{vj} = 160 \text{ }^\circ\text{C}$; 10 ms	3100	A
i^2t	$T_{vj} = 25 \text{ }^\circ\text{C}$; 8,3 ... 10 ms	72000	A^2s
	$T_{vj} = 160 \text{ }^\circ\text{C}$; 8,3 ... 10 ms	48000	A^2s
V_F	$T_{vj} = 25 \text{ }^\circ\text{C}$; $I_F = 600 \text{ A}$	max. 1,95	V
$V_{(TO)}$	$T_{vj} = 150 \text{ }^\circ\text{C}$	max. 1	V
r_T	$T_{vj} = 150 \text{ }^\circ\text{C}$	max. 2	$\text{m}\Omega$
I_{RD}	$T_{vj} = 25 \text{ }^\circ\text{C}$; $V_{RD} = V_{(BR)min}$	max. 2000	μA
	$T_{vj} = 160 \text{ }^\circ\text{C}$; $V_{RD} = V_{(BR)min}$	max. 35	mA
P_{RSM}	$T_{vj} = 160 \text{ }^\circ\text{C}$; $t_p = 10 \mu\text{s}$	60	kW
$R_{th(j-c)}$		0,2	K/W
$R_{th(c-s)}$		0,03	K/W
T_{vj}		- 40 ... + 160	$^\circ\text{C}$
T_{stg}		- 40 ... + 160	$^\circ\text{C}$
V_{isol}		-	V~
M_s	to heatsink	30	Nm
		270	lb.in.
a		5 * 9,81	m/s^2
m	approx.	260	g
Case		E 45	



SKN

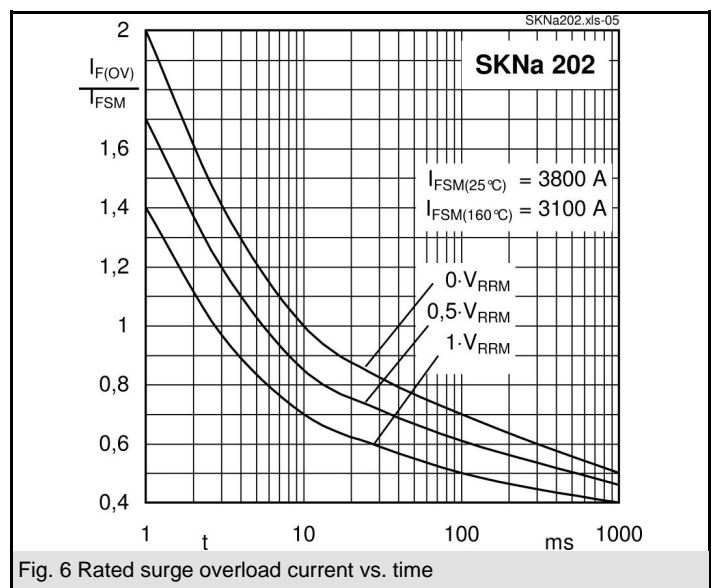
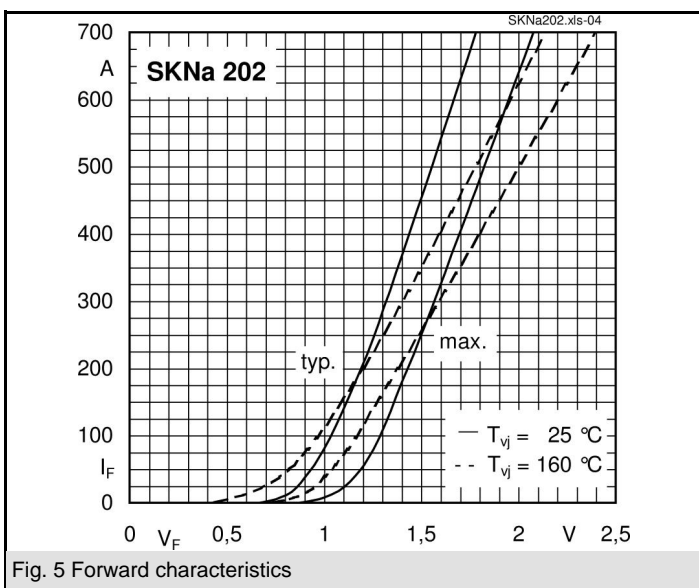
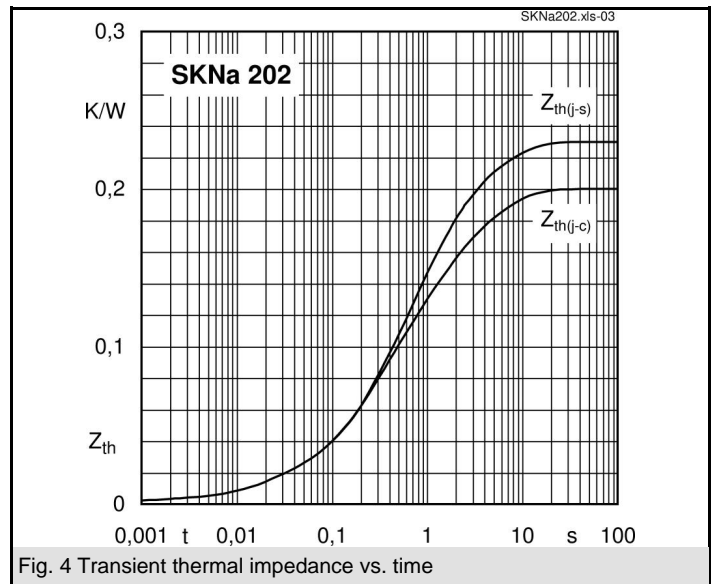
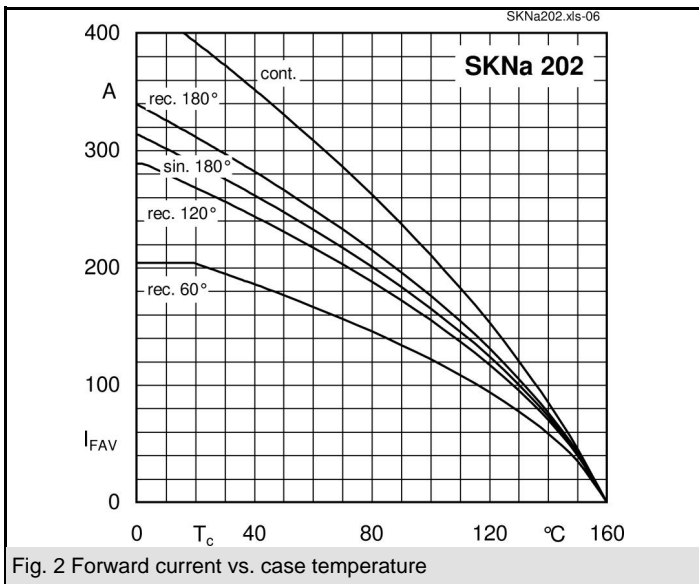
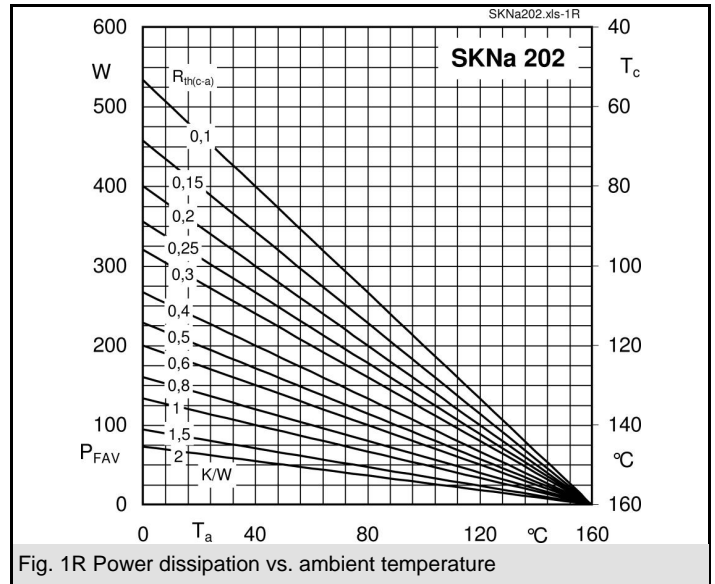
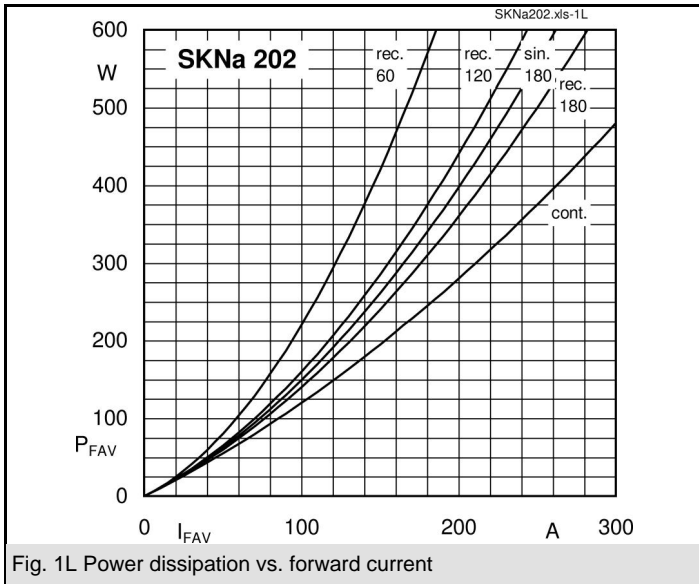

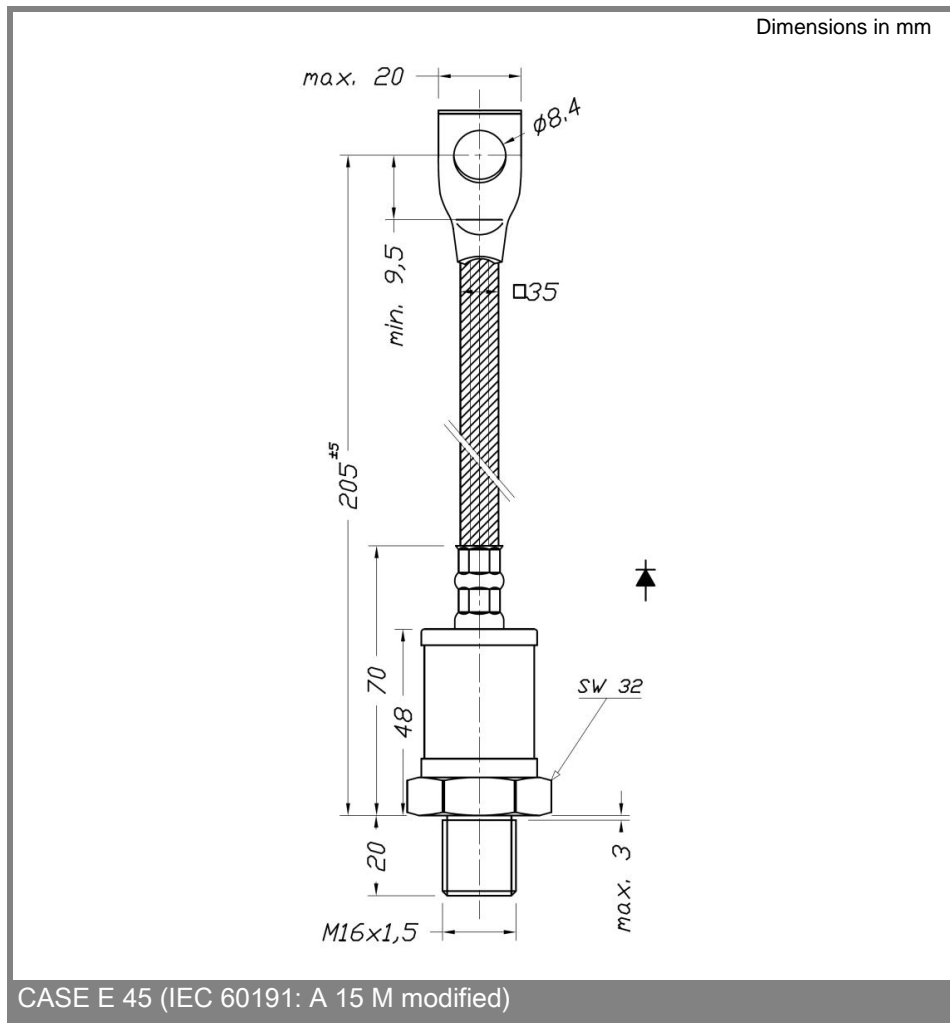

This technical information specifies semiconductor devices but promises no characteristics. No warranty or guarantee expressed or implied is made regarding delivery, performance or suitability.