

# SKKD 105F, SKMD 105F, SKND 105F

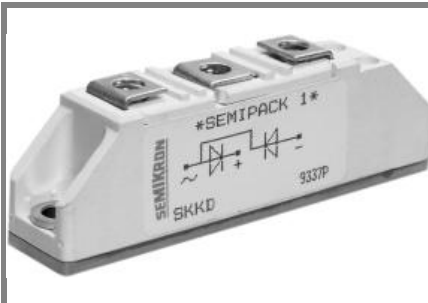

## SEMIPACK<sup>®</sup> 1

### Fast Diode Modules

**SKKD 105F**

**SKMD 105F**

**SKND 105F**

#### Features

- Heat transfer through ceramic isolated metal baseplate
- Hard soldered joints for high reliability
- SKKD half bridge connection; centre tap connections: SKMD common cathode, SKND common anode
- UL recognized, file no. E 63 532

#### Typical Applications

- Self-commutated inverters
- DC choppers
- AC motor speed control
- Inductive heating
- Uninterruptible power supplies
- Electronic welders
- General power switching applications

$V_{RSM}$ V	$V_{RRM}$ V	$I_{FRMS} = 200$ A (maximum value for continuous operation)		
		$I_{FAV} = 105$ A (sin. 180; $T_c = 83$ °C)		
800	800	SKKD 105F08	SKMD 105F08	SKND 105F08
1000	1000	SKKD 105F10	SKMD 105F10	SKND 105F10
1200	1200	SKKD 105F12	SKMD 105F12	SKND 105F12
1600	1600	SKKD 105F16		

Symbol	Conditions	Values	Units
$I_{FAV}$	sin. 180; $T_c = 85$ (100) °C	102 (65)	A
$I_{FSM}$	$T_{vj} = 25$ °C; 10 ms	2500	A
	$T_{vj} = 130$ °C; 10 ms	2100	A
$i^2t$	$T_{vj} = 25$ °C; 8,3 ... 10 ms	31250	A <sup>2</sup> s
	$T_{vj} = 130$ °C; 8,3 ... 10 ms	22000	A <sup>2</sup> s
$V_F$	$T_{vj} = 25$ °C; $I_F = 300$ A	max. 2,05	V
$V_{(TO)}$	$T_{vj} = 130$ °C	max. 1,2	V
$r_T$	$T_{vj} = 130$ °C	max. 2,5	mΩ
$I_{RD}$	$T_{vj} = 25$ °C; $V_{RD} = V_{RRM}$	max. 1	mA
$I_{RD}$	$T_{vj} = 130$ °C; $V_{RD} = V_{RRM}$	max. 30	mA
$Q_{rr}$	$T_{vj} = 130$ °C; $I_F = 100$ A,	50	μC
$I_{RM}$	$-di/dt = 50$ A/μs, $V_R = 30$ V	53	A
$t_{rr}$		1890	ns
$E_{rr}$		0,8	mJ
$R_{th(j-c)}$	per diode / per module	0,24 / 0,12	K/W
$R_{th(c-s)}$	per diode / per module	0,2 / 0,1	K/W
$T_{vj}$		- 40 ... + 130	°C
$T_{stg}$		- 40 ... + 125	°C
$V_{isol}$	a. c. 50 Hz; r.m.s; 1 s / 1 min.	3600 / 3000	V~
$M_s$	to heatsink	5 ± 15 %	Nm
$M_t$	to terminals	3 ± 15 %	Nm
$a$		5 * 9,81	m/s <sup>2</sup>
$m$	approx.	120	g
Case	SKKD	A 10	
	SKMD	A 33	
	SKND	A 37	

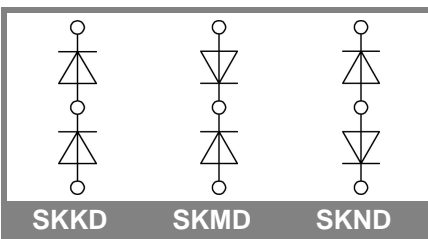

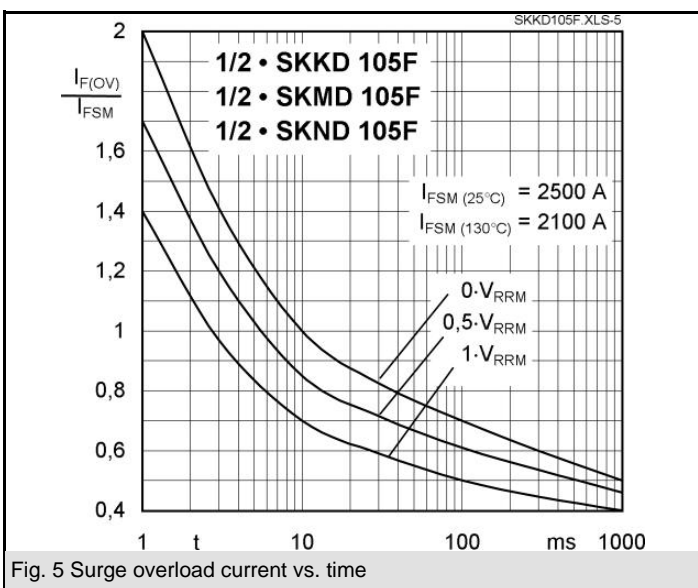
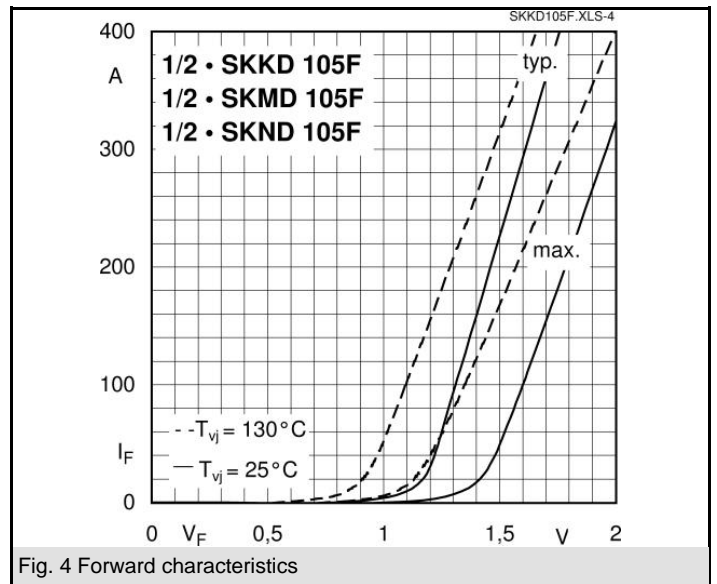
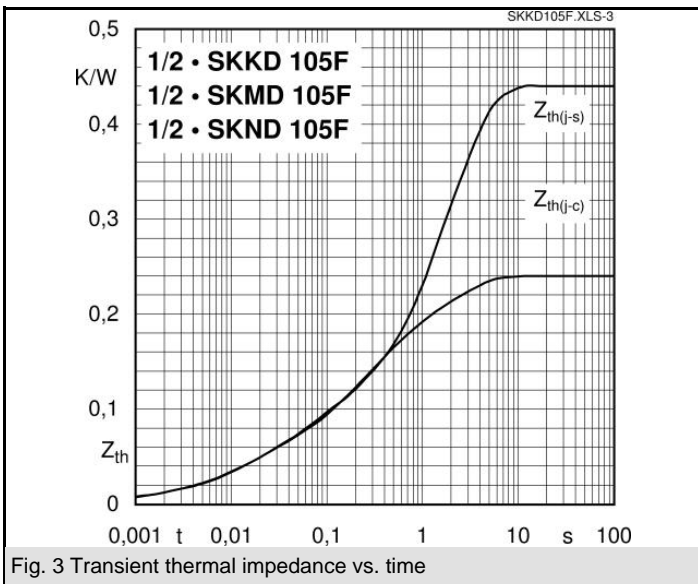
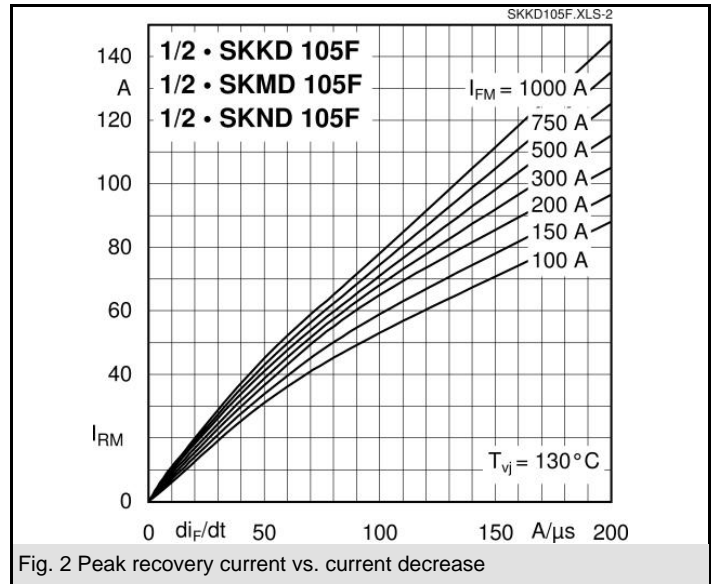
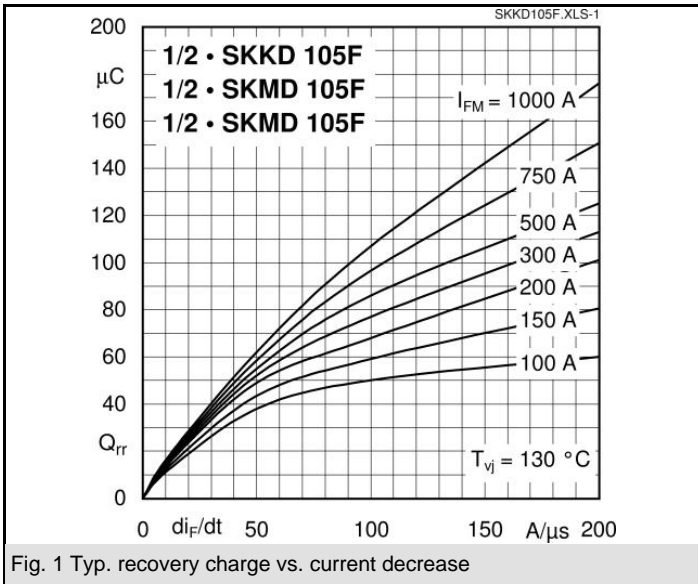

# SKKD 105F, SKMD 105F, SKND 105F

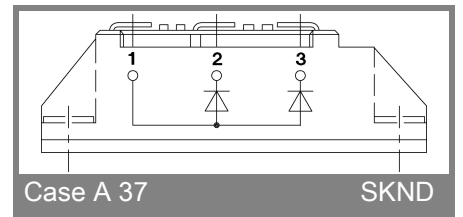
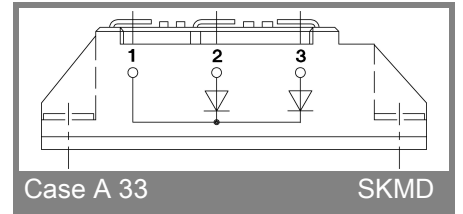
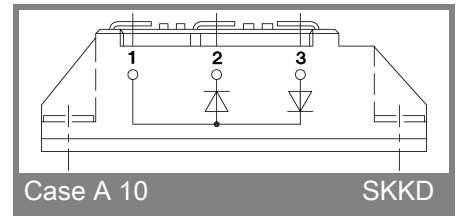
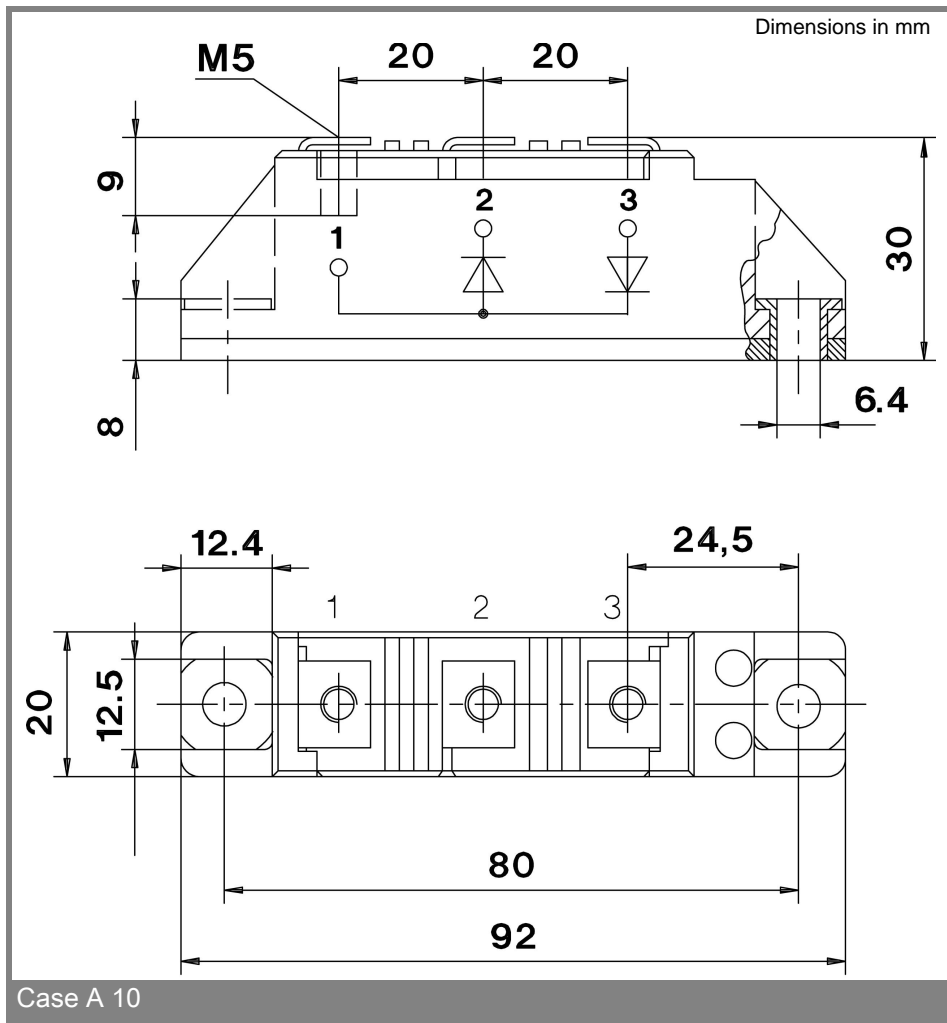

This technical information specifies semiconductor devices but promises no characteristics. No warranty or guarantee expressed or implied is made regarding delivery, performance or suitability.