

# SKM400GB12E4



**SEMITRANS® 3**

## IGBT4 Modules

### SKM400GB12E4

#### Features

- IGBT4 = 4. Generation (Trench)IGBT
- $V_{CEsat}$  with positive temperature coefficient
- High short circuit capability, self limiting to  $6 \times I_{CNOM}$
- Soft switching 4. Generation CAL diode (CAL4)
- UL recognized, file no. E63532

#### Typical Applications\*

- AC inverter drives
- UPS
- Electronic welders at  $f_{sw}$  up to 20 kHz

#### Remarks

- Case temperature limited to  $T_c = 125^\circ\text{C}$  max, recomm.  $T_{op} = -40 \dots +150^\circ\text{C}$ , product rel. results valid for  $T_j = 150^\circ$

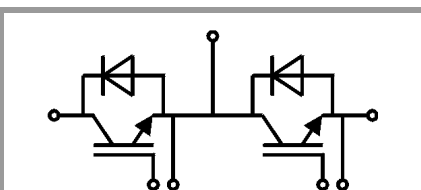

**GB**

| Absolute Maximum Ratings |  |                           |             |                  |
|--------------------------|--|---------------------------|-------------|------------------|
| Symbol                   | Conditions   |                           | Values      | Unit             |
| <b>IGBT</b>              |  |                           |             |                  |
| $V_{CES}$                | $T_j = 25^\circ\text{C}$                                     |                           | 1200        | V                |
| $I_C$                    | $T_j = 175^\circ\text{C}$                                    | $T_c = 25^\circ\text{C}$  | 616         | A                |
|                          |  | $T_c = 80^\circ\text{C}$  | 474         | A                |
| $I_{Cnom}$               |  |                           | 400         | A                |
| $I_{CRM}$                | $I_{CRM} = 3 \times I_{Cnom}$                                |                           | 1200        | A                |
| $V_{GES}$                |  |                           | -20 ... 20  | V                |
| $t_{psc}$                | $V_{CC} = 800\text{ V}$                                      | $T_j = 150^\circ\text{C}$ | 10          | $\mu\text{s}$    |
|                          | $V_{GE} \leq 15\text{ V}$                                    |                           |             |                  |
|                          | $V_{CES} \leq 1200\text{ V}$                                 |                           |             |                  |
| $T_j$                    |  |                           | -40 ... 175 | $^\circ\text{C}$ |
| <b>Inverse diode</b>     |  |                           |             |                  |
| $I_F$                    | $T_j = 175^\circ\text{C}$                                    | $T_c = 25^\circ\text{C}$  | 440         | A                |
|                          |  | $T_c = 80^\circ\text{C}$  | 329         | A                |
| $I_{Fnom}$               |  |                           | 400         | A                |
| $I_{FRM}$                | $I_{FRM} = 3 \times I_{Fnom}$                                |                           | 1200        | A                |
| $I_{FSM}$                | $t_p = 10\text{ ms, sin } 180^\circ, T_j = 25^\circ\text{C}$ |                           | 1980        | A                |
| $T_j$                    |  |                           | -40 ... 175 | $^\circ\text{C}$ |
| <b>Module</b>            |  |                           |             |                  |
| $I_{t(RMS)}$             | 80 $^\circ\text{C}$  |                           | 500         | A                |
| $T_{stg}$                |  |                           | -40 ... 125 | $^\circ\text{C}$ |
| $V_{isol}$               | AC sinus 50Hz, t = 1 min                                     |                           | 4000        | V                |

| Characteristics |   |                           |      |       |      |                  |
|-----------------|---|---------------------------|------|-------|------|------------------|
| Symbol          | Conditions  |                           | min. | typ.  | max. | Unit             |
| <b>IGBT</b>     |   |                           |      |       |      |                  |
| $V_{CE(sat)}$   | $I_C = 400\text{ A}$<br>$V_{GE} = 15\text{ V}$<br>chipelevel                          | $T_j = 25^\circ\text{C}$  |      | 1.80  | 2.05 | V                |
|                 |   | $T_j = 150^\circ\text{C}$ |      | 2.20  | 2.40 | V                |
| $V_{CE0}$       |   |                           |      | 0.8   | 0.9  | V                |
|                 |   |                           |      | 0.7   | 0.8  | V                |
| $r_{CE}$        | $V_{GE} = 15\text{ V}$  | $T_j = 25^\circ\text{C}$  |      | 2.50  | 2.88 | $\text{m}\Omega$ |
|                 |   | $T_j = 150^\circ\text{C}$ |      | 3.75  | 4.00 | $\text{m}\Omega$ |
| $V_{GE(th)}$    | $V_{GE} = V_{CE}, I_C = 15.2\text{ mA}$   |                           | 5    | 5.8   | 6.5  | V                |
| $I_{CES}$       | $V_{GE} = 0\text{ V}$<br>$V_{CE} = 1200\text{ V}$                                     | $T_j = 25^\circ\text{C}$  |      | 0.1   | 0.3  | mA               |
|                 |   | $T_j = 150^\circ\text{C}$ |      |       |      | mA               |
| $C_{ies}$       |   |                           |      | 24.6  |      | nF               |
| $C_{oes}$       | $V_{CE} = 25\text{ V}$<br>$V_{GE} = 0\text{ V}$                                       | $f = 1\text{ MHz}$        |      | 1.62  |      | nF               |
| $C_{res}$       |   | $f = 1\text{ MHz}$        |      | 1.38  |      | nF               |
| $Q_G$           | $V_{GE} = -8\text{ V} \dots +15\text{ V}$   |                           |      | 2260  |      | nC               |
| $R_{Gint}$      | $T_j = 25^\circ\text{C}$  |                           |      | 1.9   |      | $\Omega$         |
| $t_{d(on)}$     | $V_{CC} = 600\text{ V}$   | $T_j = 150^\circ\text{C}$ |      | 242   |      | ns               |
| $t_r$           | $I_C = 400\text{ A}$<br>$V_{GE} = \pm 15\text{ V}$                                    | $T_j = 150^\circ\text{C}$ |      | 47    |      | ns               |
|                 |   | $T_j = 150^\circ\text{C}$ |      | 33    |      | mJ               |
| $E_{on}$        | $R_{Gon} = 1\ \Omega$   | $T_j = 150^\circ\text{C}$ |      | 33    |      | mJ               |
| $t_{d(off)}$    | $R_{Goff} = 1\ \Omega$  | $T_j = 150^\circ\text{C}$ |      | 580   |      | ns               |
| $t_f$           | $di/dt_{on} = 9700\text{ A}/\mu\text{s}$<br>$di/dt_{off} = 4300\text{ A}/\mu\text{s}$ | $T_j = 150^\circ\text{C}$ |      | 101   |      | ns               |
|                 |   | $T_j = 150^\circ\text{C}$ |      | 56    |      | mJ               |
| $R_{th(j-c)}$   | per IGBT  |                           |      | 0.072 |      | K/W              |



**SEMITRANS® 3**

## IGBT4 Modules

### SKM400GB12E4

#### Features

- IGBT4 = 4. Generation (Trench)IGBT
- $V_{CEsat}$  with positive temperature coefficient
- High short circuit capability, self limiting to  $6 \times I_{CNOM}$
- Soft switching 4. Generation CAL diode (CAL4)
- UL recognized, file no. E63532

#### Typical Applications\*

- AC inverter drives
- UPS
- Electronic welders at  $f_{sw}$  up to 20 kHz

#### Remarks

- Case temperature limited to  $T_c = 125^\circ\text{C}$  max, recomm.
- $T_{op} = -40 \dots +150^\circ\text{C}$ , product rel. results valid for  $T_j = 150^\circ$

| Characteristics      |   |                           |      |      |       |               |
|----------------------|---|---------------------------|------|------|-------|---------------|
| Symbol               | Conditions  |                           | min. | typ. | max.  | Unit          |
| <b>Inverse diode</b> |   |                           |      |      |       |               |
| $V_F = V_{EC}$       | $I_F = 400 \text{ A}$<br>$V_{GE} = 0 \text{ V}$<br>chip | $T_j = 25^\circ\text{C}$  |      | 2.20 | 2.52  | V             |
|                      |   | $T_j = 150^\circ\text{C}$ |      | 2.15 | 2.47  | V             |
| $V_{F0}$             |   | $T_j = 25^\circ\text{C}$  |      | 1.3  | 1.5   | V             |
|                      |   | $T_j = 150^\circ\text{C}$ |      | 0.9  | 1.1   | V             |
| $r_F$                |   | $T_j = 25^\circ\text{C}$  |      | 2.3  | 2.5   | m $\Omega$    |
|                      |   | $T_j = 150^\circ\text{C}$ |      | 3.1  | 3.4   | m $\Omega$    |
| $I_{RRM}$            | $I_F = 400 \text{ A}$                                   | $T_j = 150^\circ\text{C}$ |      | 450  |       | A             |
| $Q_{rr}$             | $di/dt_{off} = 8800 \text{ A}/\mu\text{s}$              | $T_j = 150^\circ\text{C}$ |      | 68   |       | $\mu\text{C}$ |
| $E_{rr}$             | $V_{GE} = \pm 15 \text{ V}$<br>$V_{CC} = 600 \text{ V}$ | $T_j = 150^\circ\text{C}$ |      | 30.5 |       | mJ            |
| $R_{th(j-c)}$        | per diode   |                           |      |      | 0.14  | K/W           |
| <b>Module</b>        |   |                           |      |      |       |               |
| $L_{CE}$             |   |                           |      | 15   | 20    | nH            |
| $R_{CC'+EE'}$        | terminal-chip   | $T_c = 25^\circ\text{C}$  |      | 0.25 |       | m $\Omega$    |
|                      |   | $T_c = 125^\circ\text{C}$ |      | 0.5  |       | m $\Omega$    |
| $R_{th(c-s)}$        | per module  |                           |      | 0.02 | 0.038 | K/W           |
| $M_s$                | to heat sink M6   |                           | 3    |      | 5     | Nm            |
| $M_t$                |   | to terminals M6           | 2.5  |      | 5     | Nm            |
|                      |   |                           |      |      |       | Nm            |
| $w$                  |   |                           |      |      | 325   | g             |

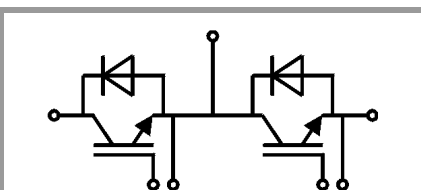

**GB**

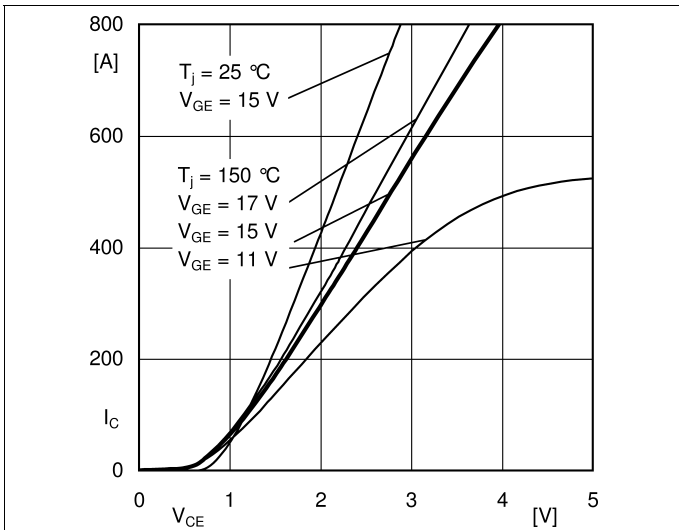

Fig. 1: Typ. output characteristic, inclusive  $R_{CC+EE}$

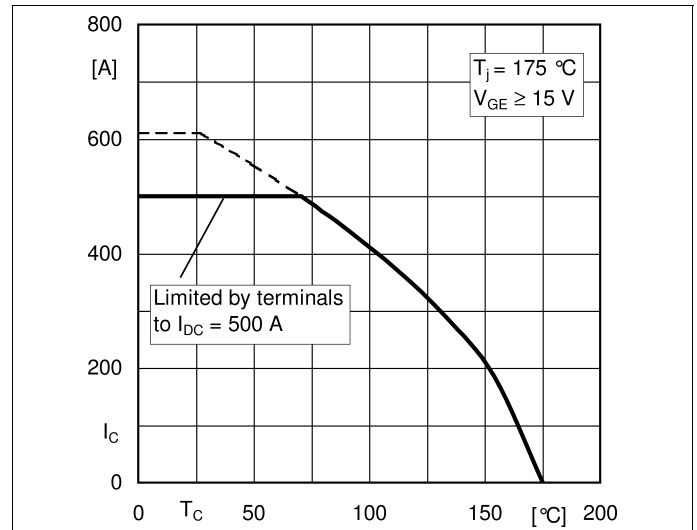

Fig. 2: Rated current vs. temperature  $I_C = f(T_C)$

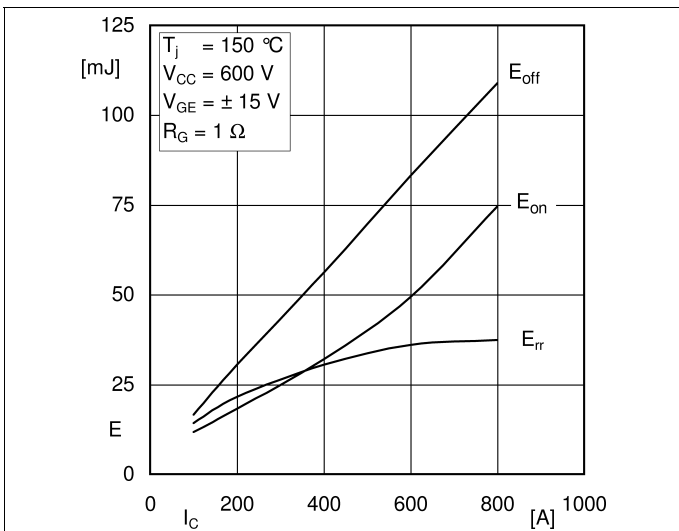

Fig. 3: Typ. turn-on /-off energy =  $f(I_C)$

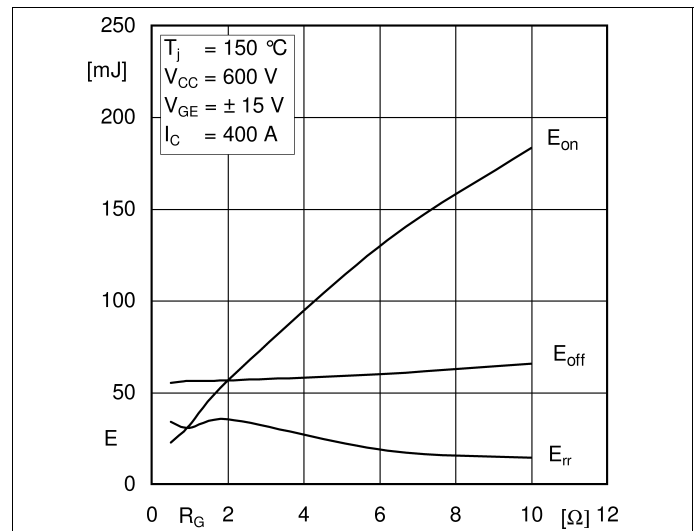

Fig. 4: Typ. turn-on /-off energy =  $f(R_G)$

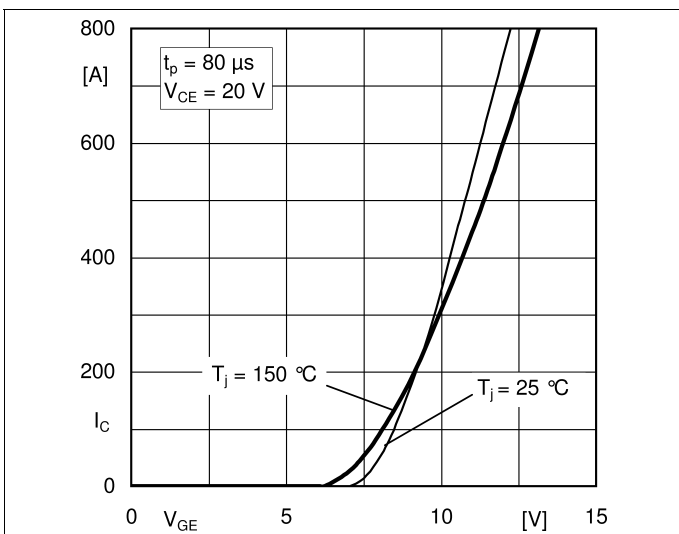

Fig. 5: Typ. transfer characteristic

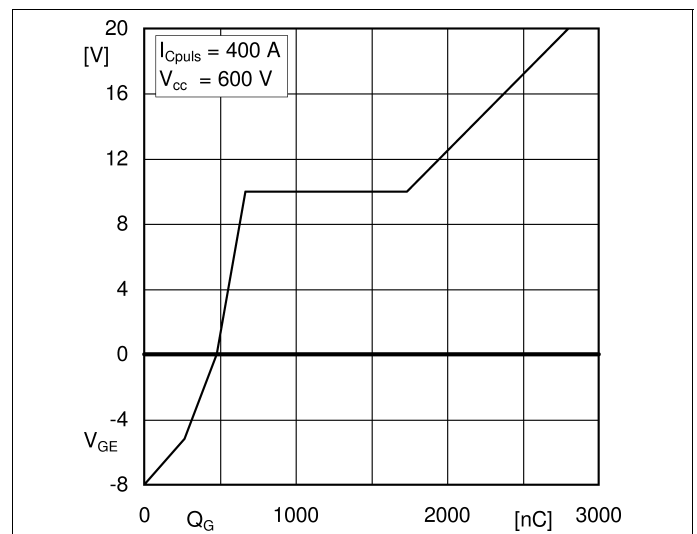

Fig. 6: Typ. gate charge characteristic

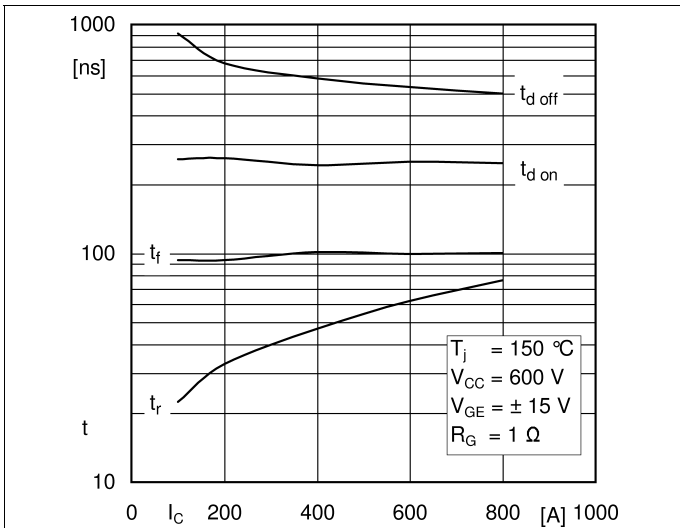

Fig. 7: Typ. switching times vs.  $I_C$

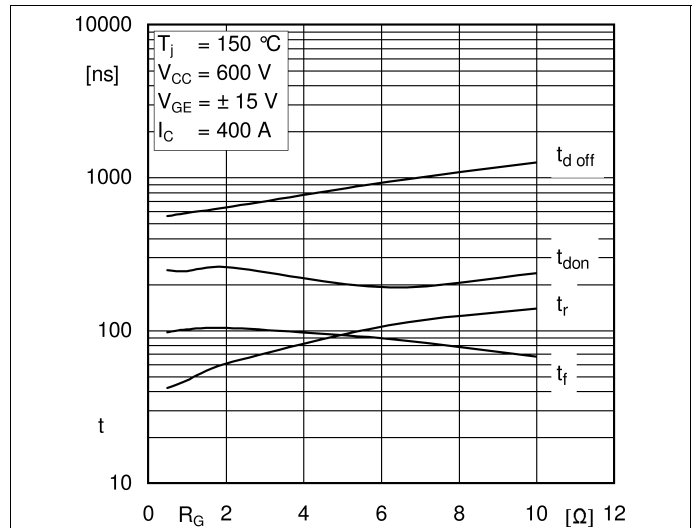

Fig. 8: Typ. switching times vs. gate resistor  $R_G$

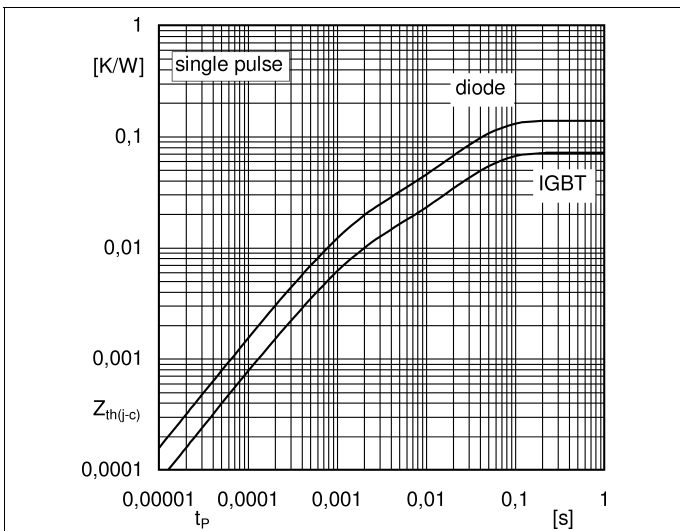

Fig. 9: Transient thermal impedance

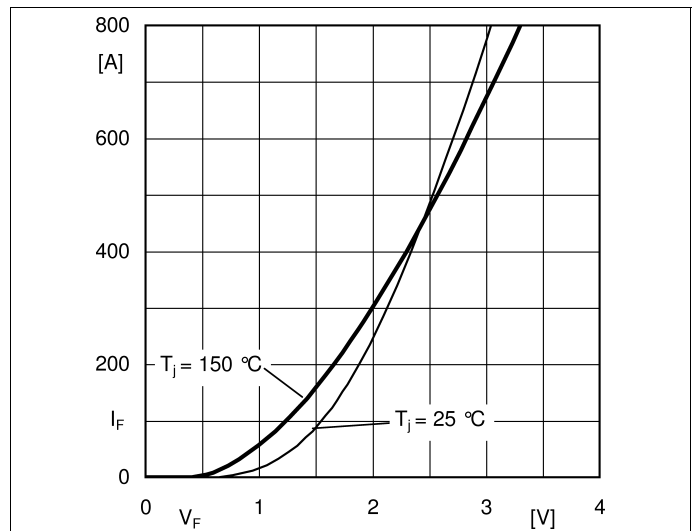

Fig. 10: Typ. CAL diode forward charact., incl.  $R_{CC+EE}$

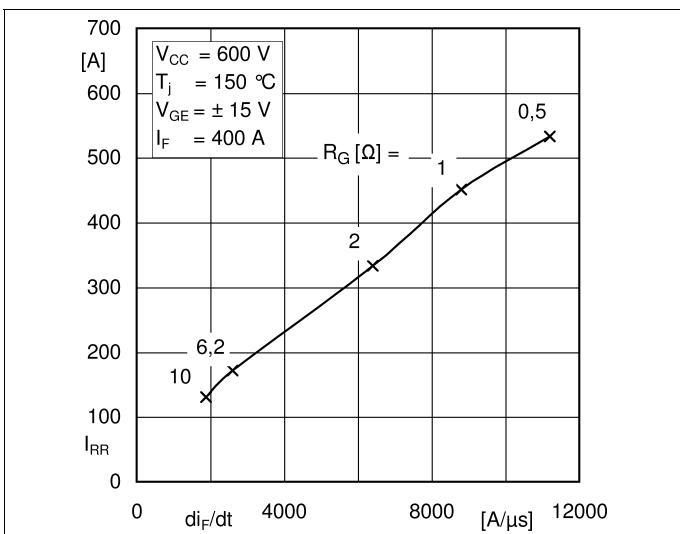

Fig. 11: CAL diode peak reverse recovery current

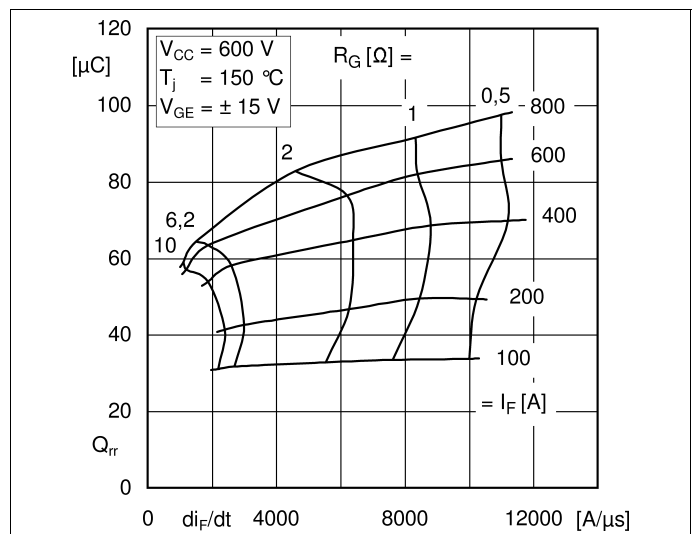
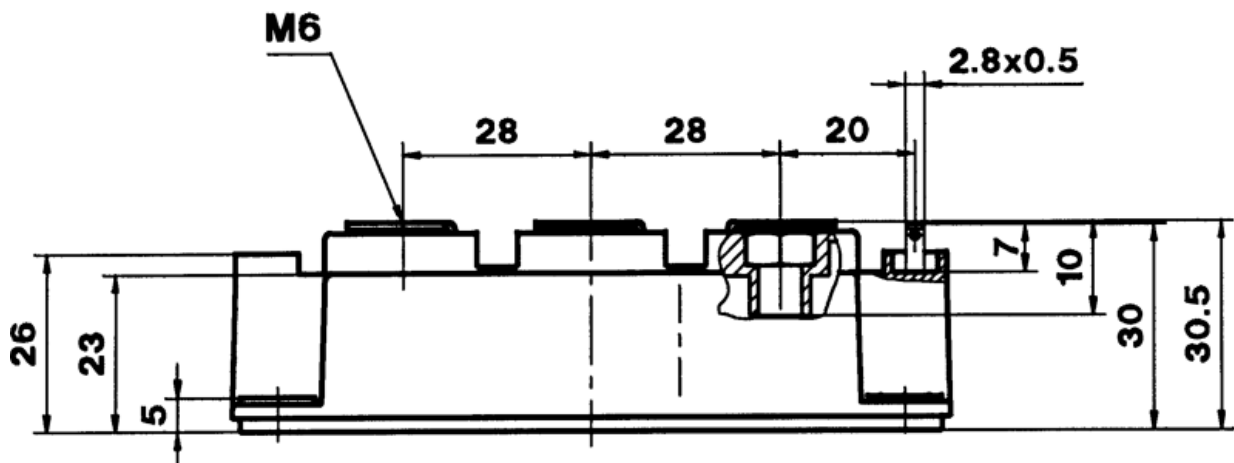
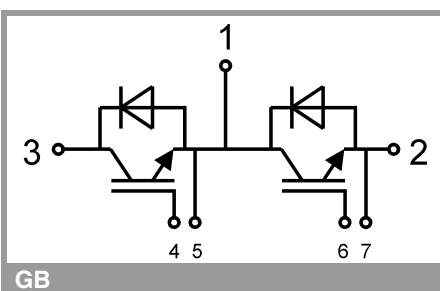

Fig. 12: Typ. CAL diode peak reverse recovery charge



SEMITRANS 3



This is an electrostatic discharge sensitive device (ESDS), international standard IEC 60747-1, Chapter IX

\* The specifications of our components may not be considered as an assurance of component characteristics. Components have to be tested for the respective application. Adjustments may be necessary. The use of SEMIKRON products in life support appliances and systems is subject to prior specification and written approval by SEMIKRON. We therefore strongly recommend prior consultation of our personal.