

# SKM 400GB123D



**SEMITRANS® 3**

## IGBT Modules

### SKM 400GB123D

#### Features

- MOS input (voltage controlled)
- N channel, homogeneous Si
- Low inductance case
- Very low tail current with low temperature dependence
- High short circuit capability, self limiting to  $6 \times I_{Cnom}$
- Latch-up free
- Fast & soft CAL diodes
- Isolated copper baseplate using DBC Direct Copper Bonding Technology
- Large clearance (12 mm) and creepage distances (20 mm)

#### Typical Applications\*

- AC inverter drives
- UPS



**GB**

Absolute Maximum Ratings		$T_C = 25\text{ °C}$ , unless otherwise specified			
Symbol	Conditions	Values			Units
<b>IGBT</b>					
$V_{CES}$	$T_j = 25\text{ °C}$	1200			V
$I_C$	$T_j = 150\text{ °C}$	$T_{case} = 25\text{ °C}$	400		A
		$T_{case} = 80\text{ °C}$	330		A
$I_{CRM}$	$I_{CRM} = 2 \times I_{Cnom}$	600			A
$V_{GES}$		$\pm 20$			V
$t_{psc}$	$V_{CC} = 600\text{ V}; V_{GE} \leq 20\text{ V}; T_j = 125\text{ °C}$ $V_{CES} < 1200\text{ V}$	10			$\mu\text{s}$
<b>Inverse Diode</b>					
$I_F$	$T_j = 150\text{ °C}$	$T_{case} = 25\text{ °C}$	390		A
		$T_{case} = 80\text{ °C}$	260		A
$I_{FRM}$	$I_{FRM} = 2 \times I_{Fnom}$	600			A
$I_{FSM}$	$t_p = 10\text{ ms}; \text{sin.}$	$T_j = 150\text{ °C}$	2880		A
<b>Module</b>					
$I_{t(RMS)}$		500			A
$T_{vj}$		- 40...+ 150			$^{\circ}\text{C}$
$T_{stg}$		- 40...+ 125			$^{\circ}\text{C}$
$V_{isol}$	AC, 1 min.	2500			V

Characteristics		$T_C = 25\text{ °C}$ , unless otherwise specified			
Symbol	Conditions	min.	typ.	max.	Units
<b>IGBT</b>					
$V_{GE(th)}$	$V_{GE} = V_{CE}, I_C = 12\text{ mA}$	4,5	5,5	6,5	V
$I_{CES}$	$V_{GE} = 0\text{ V}, V_{CE} = V_{CES}$		0,1	0,3	mA
$V_{CE0}$		$T_j = 25\text{ °C}$	1,4	1,6	V
		$T_j = 125\text{ °C}$	1,6	1,8	V
$r_{CE}$	$V_{GE} = 15\text{ V}$	$T_j = 25\text{ °C}$	3,66	4,66	m $\Omega$
		$T_j = 125\text{ °C}$	5	6,33	m $\Omega$
$V_{CE(sat)}$	$I_{Cnom} = 300\text{ A}, V_{GE} = 15\text{ V}$	$T_j = ^{\circ}\text{C}_{chiplev.}$	2,5	3	V
$C_{ies}$	$V_{CE} = 25, V_{GE} = 0\text{ V}$	$f = 1\text{ MHz}$	22	30	nF
$C_{oes}$			3,3	4	nF
$C_{res}$			1,2	1,6	nF
$Q_G$	$V_{GE} = -8\text{ V} - +20\text{ V}$		3000		nC
$R_{Gint}$	$T_j = ^{\circ}\text{C}$		1,25		$\Omega$
$t_{d(on)}$	$R_{Gon} = 3,3\ \Omega$	$V_{CC} = 600\text{ V}$ $I_C = 300\text{ A}$	200	400	ns
$t_r$			115	220	ns
$E_{on}$			38		mJ
$t_{d(off)}$	$R_{Goff} = 3,3\ \Omega$	$T_j = 125\text{ °C}$ $V_{GE} = \pm 15\text{ V}$	720	900	ns
$t_f$			80	100	ns
$E_{off}$			40		mJ
$R_{th(j-c)}$	per IGBT			0,05	K/W



**SEMITRANS® 3**

## IGBT Modules

### SKM 400GB123D

#### Features

- MOS input (voltage controlled)
- N channel, homogeneous Si
- Low inductance case
- Very low tail current with low temperature dependence
- High short circuit capability, self limiting to  $6 \times I_{cnom}$
- Latch-up free
- Fast & soft CAL diodes
- Isolated copper baseplate using DBC Direct Copper Bonding Technology
- Large clearance (12 mm) and creepage distances (20 mm)

#### Typical Applications\*

- AC inverter drives
- UPS



**GB**

Characteristics			min.	typ.	max.	Units
Symbol	Conditions					
<b>Inverse Diode</b>						
$V_F = V_{EC}$	$I_{Fnom} = 300 \text{ A}; V_{GE} = 0 \text{ V}$	$T_j = 25 \text{ }^\circ\text{C}_{chiplev.}$		2	2,5	V
		$T_j = 125 \text{ }^\circ\text{C}_{chiplev.}$		1,8		V
$V_{F0}$		$T_j = 25 \text{ }^\circ\text{C}$		1,1	1,2	V
		$T_j = 125 \text{ }^\circ\text{C}$				V
$r_F$		$T_j = 25 \text{ }^\circ\text{C}$		3	4,3	mΩ
		$T_j = 125 \text{ }^\circ\text{C}$				mΩ
$I_{RRM}$	$I_F = 300 \text{ A}$	$T_j = 125 \text{ }^\circ\text{C}$		140		A
$Q_{rr}$	$di/dt = 2000 \text{ A}/\mu\text{s}$			13		μC
$E_{rr}$	$V_{GE} = 0 \text{ V}; V_{CC} = 600 \text{ V}$					mJ
$R_{th(j-c)D}$	per diode				0,125	K/W
<b>Module</b>						
$L_{CE}$				15	20	nH
$R_{CC'+EE'}$	res., terminal-chip	$T_{case} = 25 \text{ }^\circ\text{C}$		0,35		mΩ
		$T_{case} = 125 \text{ }^\circ\text{C}$		0,5		mΩ
$R_{th(c-s)}$	per module				0,038	K/W
$M_s$	to heat sink M6			3	5	Nm
w					325	g

This is an electrostatic discharge sensitive device (ESDS), international standard IEC 60747-1, Chapter IX.

\* The specifications of our components may not be considered as an assurance of component characteristics. Components have to be tested for the respective application. Adjustments may be necessary. The use of SEMIKRON products in life support appliances and systems is subject to prior specification and written approval by SEMIKRON. We therefore strongly recommend prior consultation of our personal.

# SKM 400GB123D



**SEMITRANS® 3**

## IGBT Modules

**SKM 400GB123D**

### Features

- MOS input (voltage controlled)
- N channel, homogeneous Si
- Low inductance case
- Very low tail current with low temperature dependence
- High short circuit capability, self limiting to  $6 \times I_{cnom}$
- Latch-up free
- Fast & soft CAL diodes
- Isolated copper baseplate using DBC Direct Copper Bonding Technology
- Large clearance (12 mm) and creepage distances (20 mm)

### Typical Applications\*

- AC inverter drives
- UPS



**GB**

$Z_{th}$		Conditions	Values	Units
<b><math>Z_{th(j-c)I}</math></b>				
$R_{\theta j-c}$	$i = 1$		32	mk/W
$R_{\theta j-c}$	$i = 2$		14	mk/W
$R_{\theta j-c}$	$i = 3$		3,4	mk/W
$R_{\theta j-c}$	$i = 4$		0,6	mk/W
$\tau_{th(j-c)I}$	$i = 1$		0,0447	s
$\tau_{th(j-c)I}$	$i = 2$		0,0122	s
$\tau_{th(j-c)I}$	$i = 3$		0,004	s
$\tau_{th(j-c)I}$	$i = 4$		0,0002	s
<b><math>Z_{th(j-c)D}</math></b>				
$R_{\theta j-c}$	$i = 1$		80	mk/W
$R_{\theta j-c}$	$i = 2$		33	mk/W
$R_{\theta j-c}$	$i = 3$		10,2	mk/W
$R_{\theta j-c}$	$i = 4$		1,8	mk/W
$\tau_{th(j-c)D}$	$i = 1$		0,05	s
$\tau_{th(j-c)D}$	$i = 2$		0,0057	s
$\tau_{th(j-c)D}$	$i = 3$		0,0034	s
$\tau_{th(j-c)D}$	$i = 4$		0,0003	s

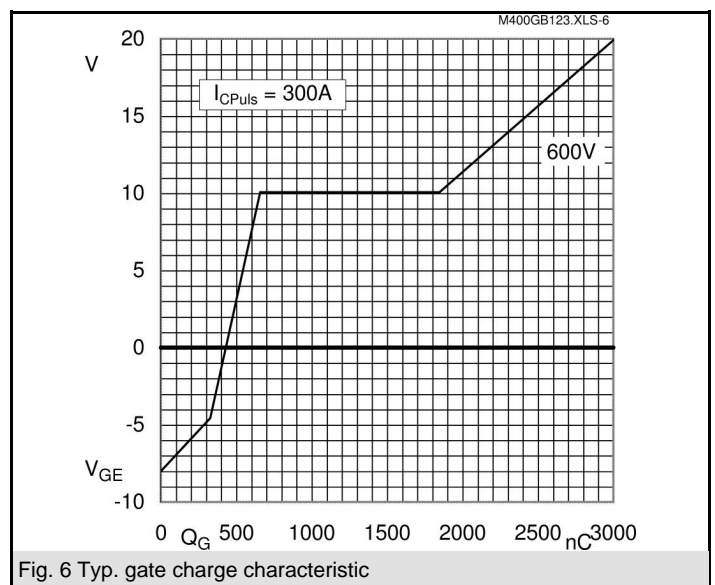
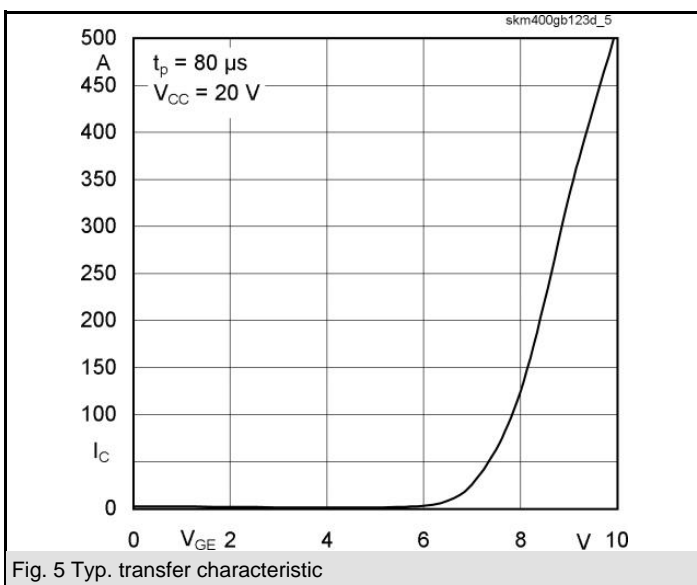
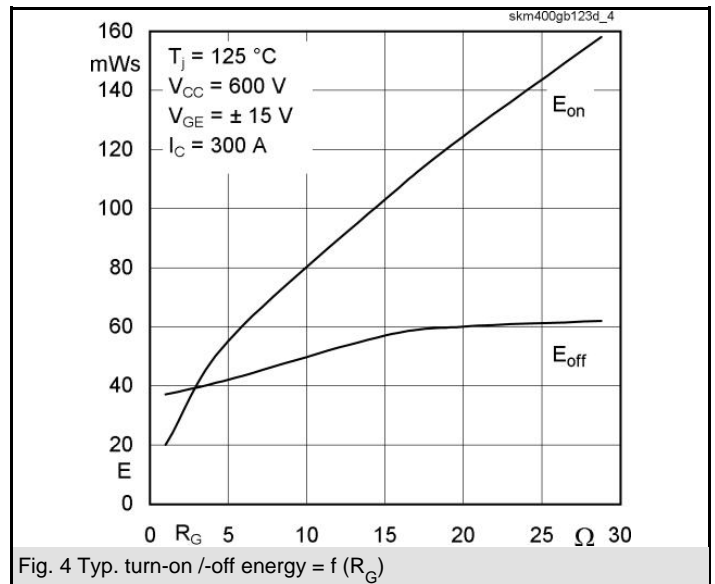
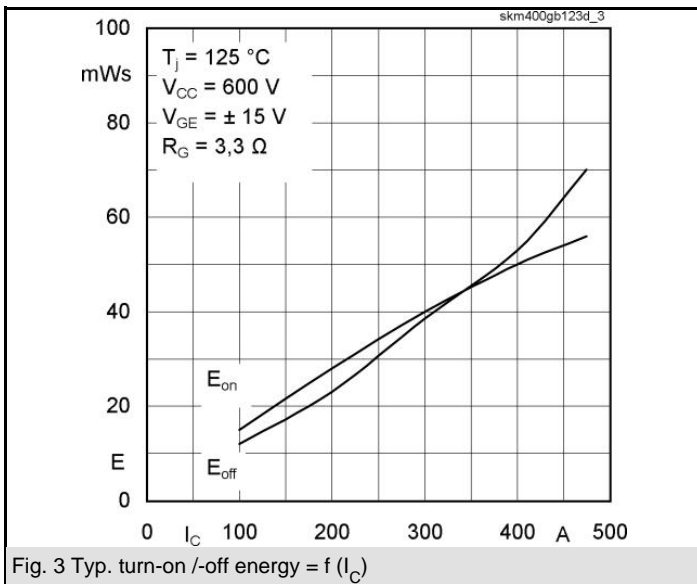
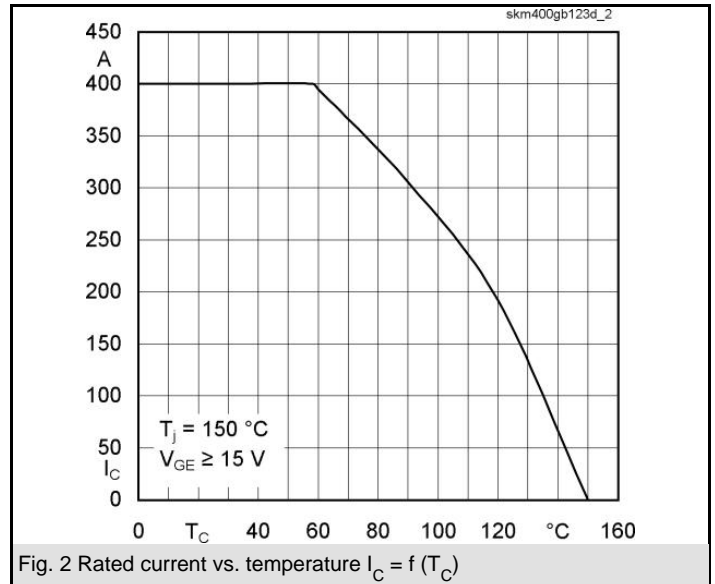
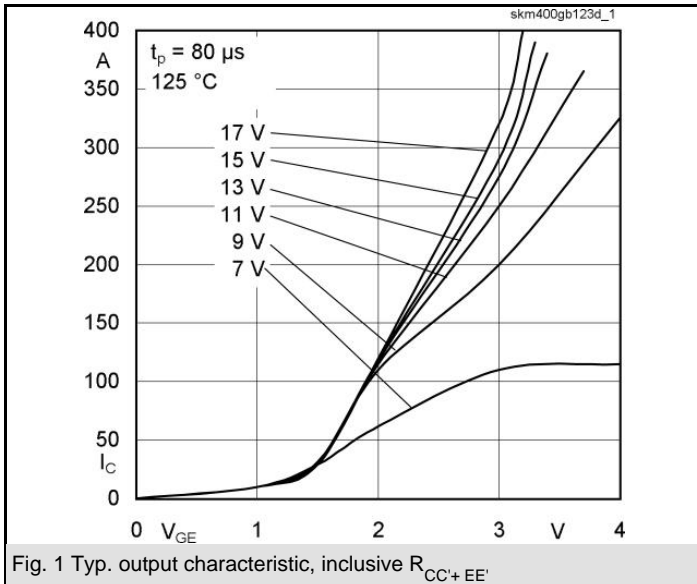

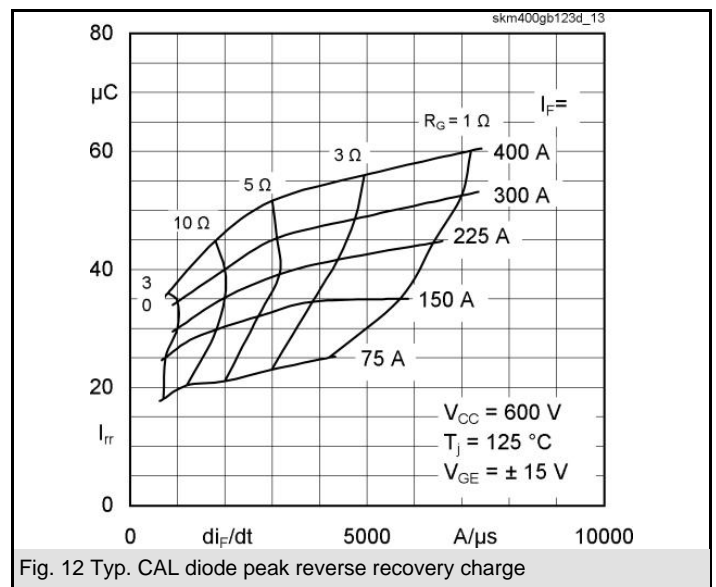
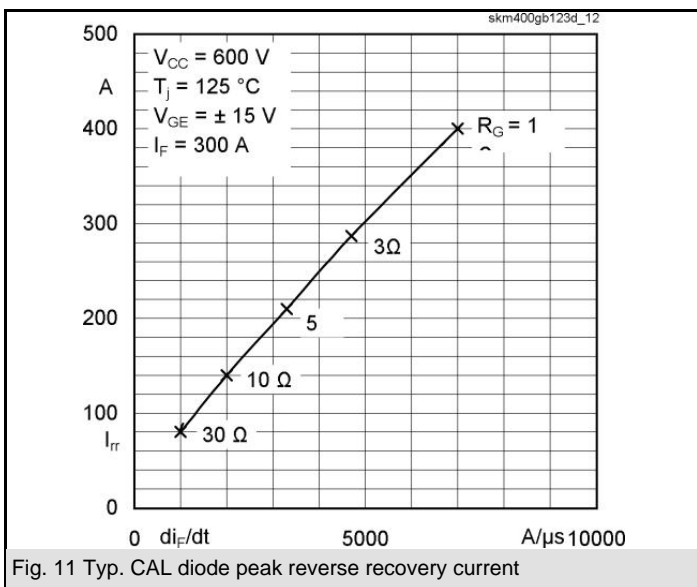
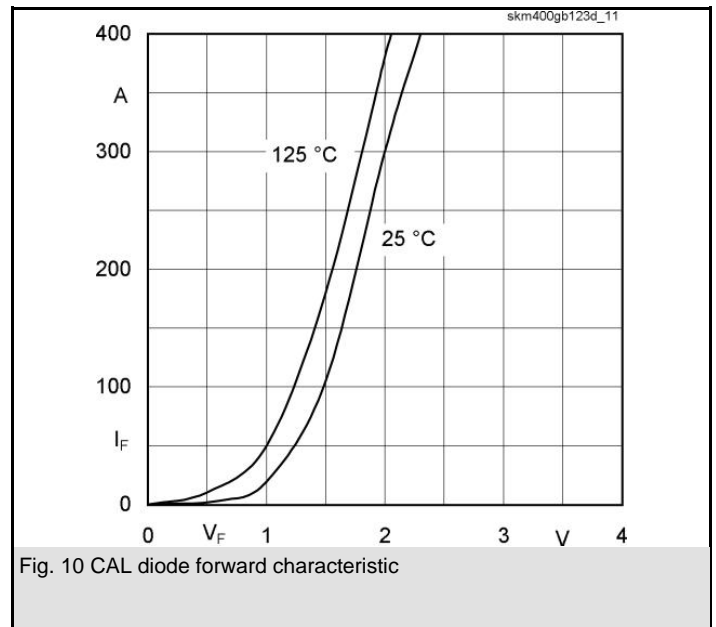
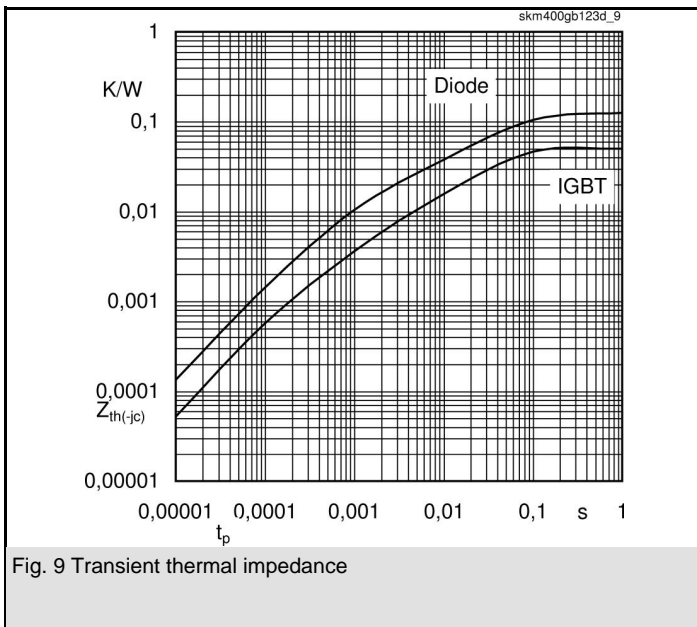
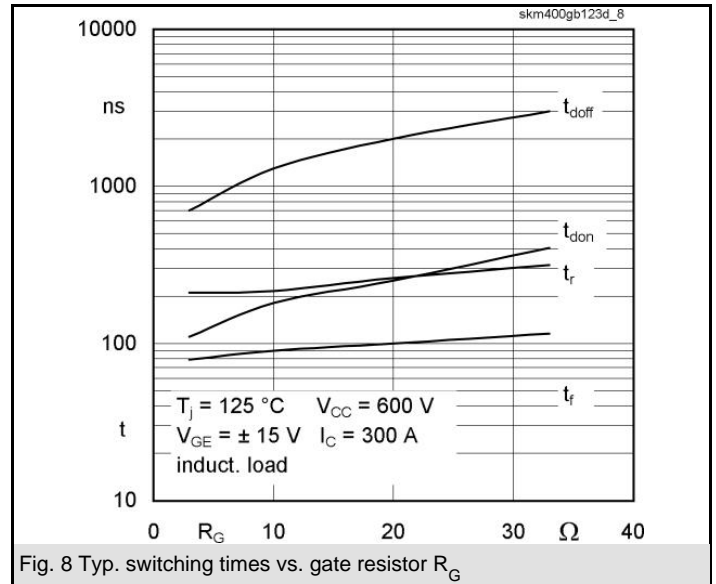
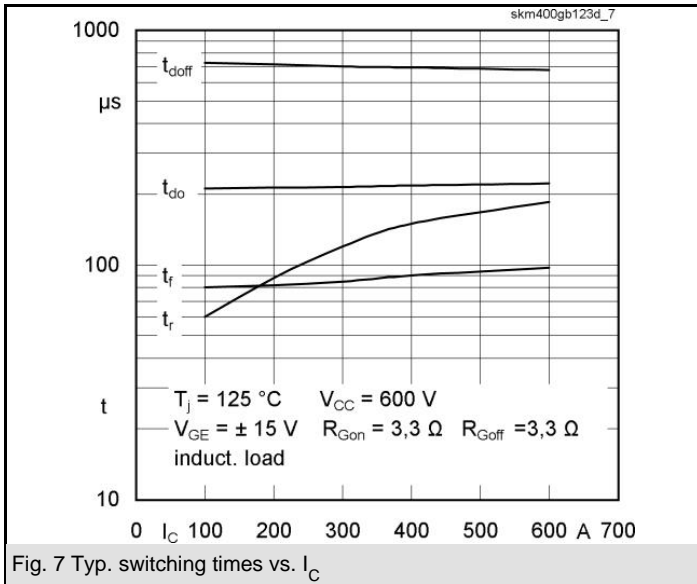

# SKM 400GB123D

UL Recognized

CASED56

File 63 532

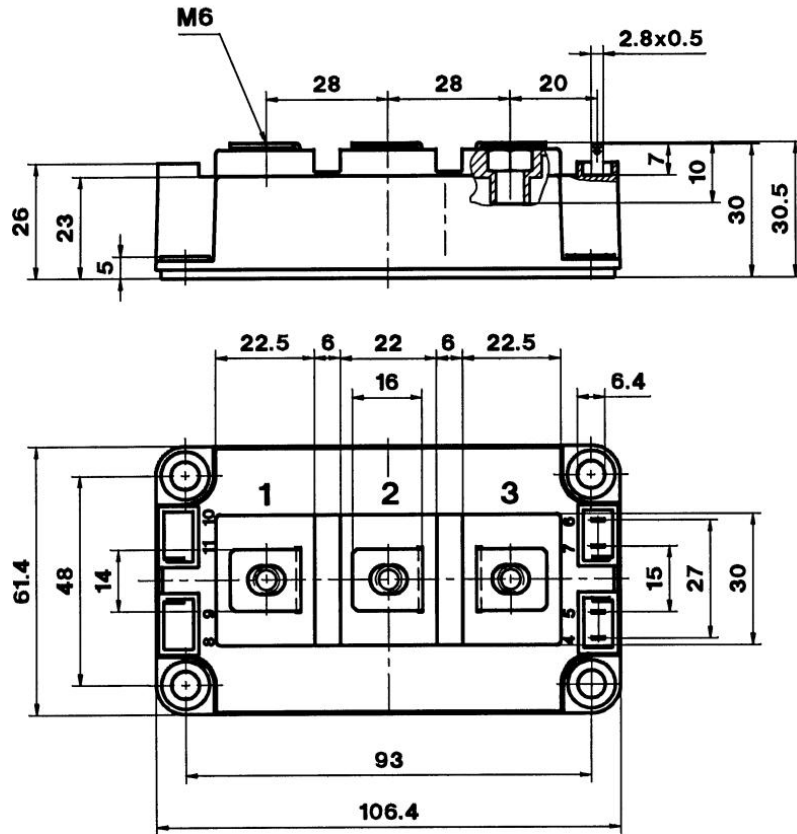

Case D 56



GB

Case D 56