



**SEMITRANS®3**

## IGBT4 Modules

SKM400GAL12E4

### Features

- IGBT4 = 4. Generation (Trench)IGBT
- VCEsat with positive temperature coefficient
- High short circuit capability, self limiting to 6 x I<sub>CNOM</sub>
- Soft switching 4. Generation CAL diode (CAL4)

### Typical Applications

- DC/DC – converter
- Brake chopper
- Switched reluctance motor
- DC – motor

### Remarks

- Case temperature limited to T<sub>c</sub> = 125°C max, recomm. T<sub>op</sub> = -40 ... +150°C, product rel. results valid for T<sub>j</sub> = 150°

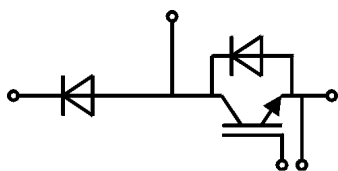

GAL

### Absolute Maximum Ratings

Symbol	Conditions	Values	Unit	
<b>IGBT</b>				
V <sub>CES</sub>		1200	V	
I <sub>C</sub>	T <sub>j</sub> = 175 °C	T <sub>c</sub> = 25 °C T <sub>c</sub> = 80 °C	618 475	A A
I <sub>Cnom</sub>		400	A	
I <sub>CRM</sub>	I <sub>CRM</sub> = 3xI <sub>Cnom</sub>	1200	A	
V <sub>GES</sub>		-20 ... 20	V	
t <sub>psc</sub>	V <sub>CC</sub> = 800 V V <sub>GE</sub> ≤ 15 V V <sub>CES</sub> ≤ 1200 V	T <sub>j</sub> = 150 °C	10	µs
T <sub>j</sub>		-40 ... 175	°C	
<b>Inverse diode</b>				
I <sub>F</sub>	T <sub>j</sub> = 175 °C	T <sub>c</sub> = 25 °C T <sub>c</sub> = 80 °C	440 329	A A
I <sub>Fnom</sub>		400	A	
I <sub>FRM</sub>	I <sub>FRM</sub> = 3xI <sub>Fnom</sub>	1200	A	
I <sub>FSM</sub>	t <sub>p</sub> = 10 ms, sin 180°, T <sub>j</sub> = 25 °C	1980	A	
T <sub>j</sub>		-40 ... 175	°C	
<b>Freewheeling diode</b>				
I <sub>F</sub>	T <sub>j</sub> = 175 °C	T <sub>c</sub> = 25 °C T <sub>c</sub> = 80 °C	440 329	A A
I <sub>Fnom</sub>		400	A	
I <sub>FRM</sub>	I <sub>FRM</sub> = 3xI <sub>Fnom</sub>	1200	A	
I <sub>FSM</sub>	t <sub>p</sub> = 10 ms, sin 180°, T <sub>j</sub> = 25 °C	1980	A	
T <sub>j</sub>		-40 ... 175	°C	
<b>Module</b>				
I <sub>t(RMS)</sub>		500	A	
T <sub>stg</sub>		-40 ... 125	°C	
V <sub>isol</sub>	AC sinus 50Hz, t = 1 min	4000	V	

### Characteristics

Symbol	Conditions	min.	typ.	max.	Unit
<b>IGBT</b>					
V <sub>CE(sat)</sub>	I <sub>C</sub> = 400 A V <sub>GE</sub> = 15 V chipelevel				
					T <sub>j</sub> = 25 °C T <sub>j</sub> = 150 °C
			1.8 2.2	2.05 2.4	V V
V <sub>CE0</sub>					T <sub>j</sub> = 25 °C T <sub>j</sub> = 150 °C
			0.8 0.7	0.9 0.8	V V
r <sub>CE</sub>	V <sub>GE</sub> = 15 V				T <sub>j</sub> = 25 °C T <sub>j</sub> = 150 °C
			2.5 3.8	2.9 4.0	mΩ mΩ
V <sub>GE(th)</sub>	V <sub>GE</sub> =V <sub>CE</sub> , I <sub>C</sub> = 15.2 mA	5	5.8	6.5	V
I <sub>CES</sub>	V <sub>GE</sub> = 0 V V <sub>CE</sub> = 1200 V				T <sub>j</sub> = 25 °C T <sub>j</sub> = 150 °C
			0.1	0.3	mA mA
C <sub>ies</sub>	V <sub>CE</sub> = 25 V		24.6		f = 1 MHz nF
C <sub>oes</sub>	V <sub>GE</sub> = 0 V		1.62		f = 1 MHz nF
C <sub>res</sub>			1.38		f = 1 MHz nF
Q <sub>G</sub>	V <sub>GE</sub> = - 8 V...+ 15 V		2260		nC
R <sub>Gint</sub>	T <sub>j</sub> = 25 °C		1.9		Ω



**SEMITRANS®3**

## IGBT4 Modules

SKM400GAL12E4

### Features

- IGBT4 = 4. Generation (Trench)IGBT
- VCEsat with positive temperature coefficient
- High short circuit capability, self limiting to  $6 \times I_{CNOM}$
- Soft switching 4. Generation CAL diode (CAL4)

### Typical Applications

- DC/DC – converter
- Brake chopper
- Switched reluctance motor
- DC – motor

### Remarks

- Case temperature limited to  $T_c = 125^\circ\text{C}$  max, recomm.  
 $T_{op} = -40 \dots +150^\circ\text{C}$ , product rel. results valid for  $T_j = 150^\circ$

Characteristics						
Symbol	Conditions		min.	typ.	max.	Unit
$t_{d(on)}$	$V_{CC} = 600\text{ V}$	$T_j = 150^\circ\text{C}$		242		ns
$t_r$	$I_C = 400\text{ A}$	$T_j = 150^\circ\text{C}$		47		ns
$E_{on}$	$V_{GE} = \pm 15\text{ V}$	$T_j = 150^\circ\text{C}$		33		mJ
$t_{d(off)}$	$R_{G\ on} = 1\ \Omega$	$T_j = 150^\circ\text{C}$		580		ns
$t_f$	$R_{G\ off} = 1\ \Omega$	$T_j = 150^\circ\text{C}$		101		ns
$E_{off}$	$di/dt_{on} = 9700\text{ A}/\mu\text{s}$	$T_j = 150^\circ\text{C}$		56		mJ
$R_{th(j-c)}$	per IGBT				0.072	K/W
Inverse diode						
$V_F = V_{EC}$	$I_F = 400\text{ A}$	$T_j = 25^\circ\text{C}$		2.2	2.52	V
	$V_{GE} = 0\text{ V}$ chip	$T_j = 150^\circ\text{C}$		2.15	2.47	V
$V_{F0}$		$T_j = 25^\circ\text{C}$		1.3	1.5	V
		$T_j = 150^\circ\text{C}$		0.9	1.1	V
$r_F$		$T_j = 25^\circ\text{C}$		2.3	2.5	m $\Omega$
		$T_j = 150^\circ\text{C}$		3.1	3.4	m $\Omega$
$I_{RRM}$	$I_F = 400\text{ A}$	$T_j = 150^\circ\text{C}$		450		A
$Q_{rr}$	$di/dt_{off} = 8800\text{ A}/\mu\text{s}$	$T_j = 150^\circ\text{C}$		68		$\mu\text{C}$
$E_{rr}$	$V_{GE} = \pm 15\text{ V}$ $V_{CC} = 600\text{ V}$	$T_j = 150^\circ\text{C}$		30.5		mJ
$R_{th(j-c)}$	per diode				0.14	K/W
Freewheeling diode						
$V_F = V_{EC}$	$I_F = 400\text{ A}$	$T_j = 25^\circ\text{C}$		2.2	2.52	V
	$V_{GE} = 0\text{ V}$ chip	$T_j = 150^\circ\text{C}$		2.15	2.47	V
$V_{F0}$		$T_j = 25^\circ\text{C}$		1.3	1.5	V
		$T_j = 150^\circ\text{C}$		0.9	1.1	V
$r_F$		$T_j = 25^\circ\text{C}$		2.3	2.5	m $\Omega$
		$T_j = 150^\circ\text{C}$		3.1	3.4	m $\Omega$
$I_{RRM}$	$I_F = 400\text{ A}$	$T_j = 150^\circ\text{C}$		450		A
$Q_{rr}$	$di/dt_{off} = 8800\text{ A}/\mu\text{s}$	$T_j = 150^\circ\text{C}$		68		$\mu\text{C}$
$E_{rr}$	$V_{GE} = \pm 15\text{ V}$ $V_{CC} = 600\text{ V}$	$T_j = 150^\circ\text{C}$		30.5		mJ
$R_{th(j-c)}$	per Diode				0.14	K/W
Module						
$L_{CE}$				15	20	nH
$R_{CC+EE'}$	terminal-chip	$T_C = 25^\circ\text{C}$		0.25		m $\Omega$
		$T_C = 125^\circ\text{C}$		0.5		m $\Omega$
$R_{th(c-s)}$	per module			0.02	0.038	K/W
$M_s$	to heat sink M6			3	5	Nm
$M_t$		to terminals M6		2.5	5	Nm
						Nm
$w$					325	g

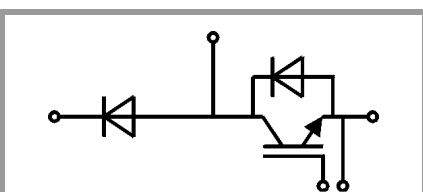

GAL

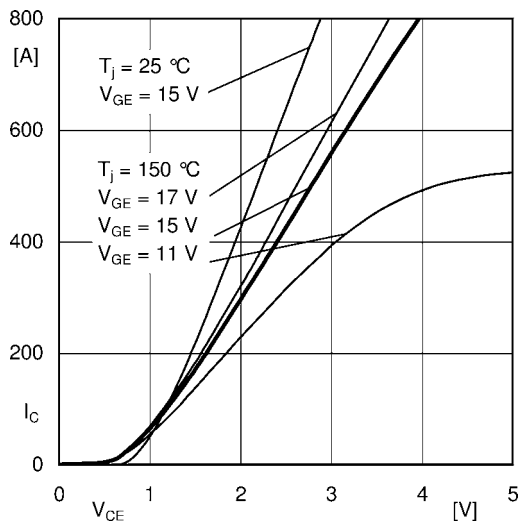

Fig. 1: Typ. output characteristic, inclusive  $R_{CC'+EE'}$

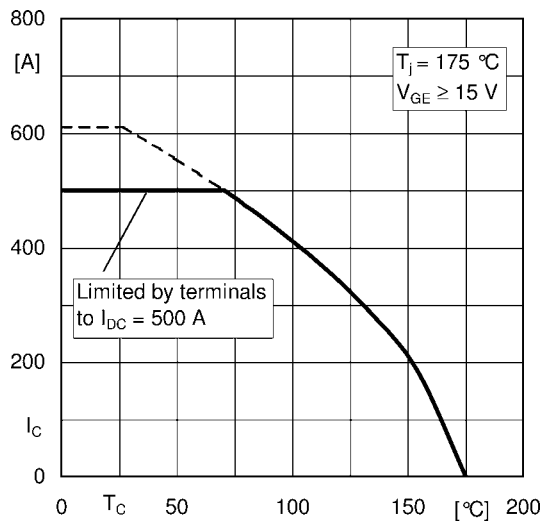

Fig. 2: Rated current vs. temperature  $I_C = f(T_C)$

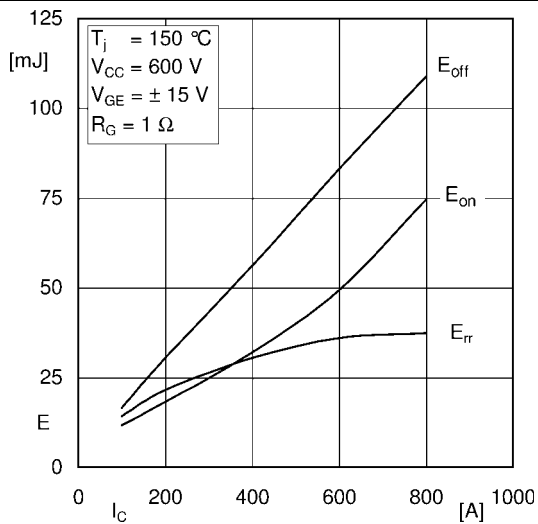

Fig. 3: Typ. turn-on /-off energy =  $f(I_C)$

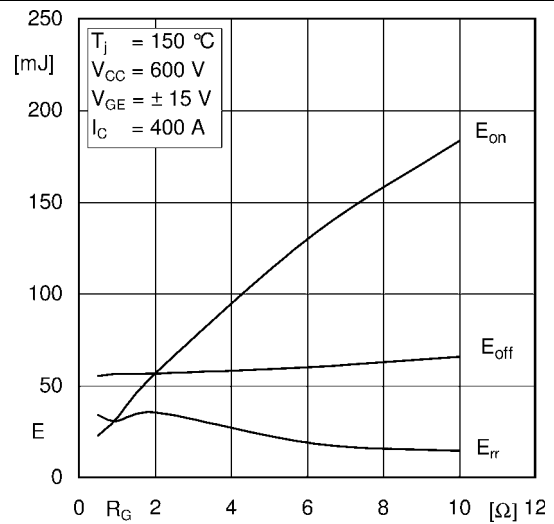

Fig. 4: Typ. turn-on /-off energy =  $f(R_G)$

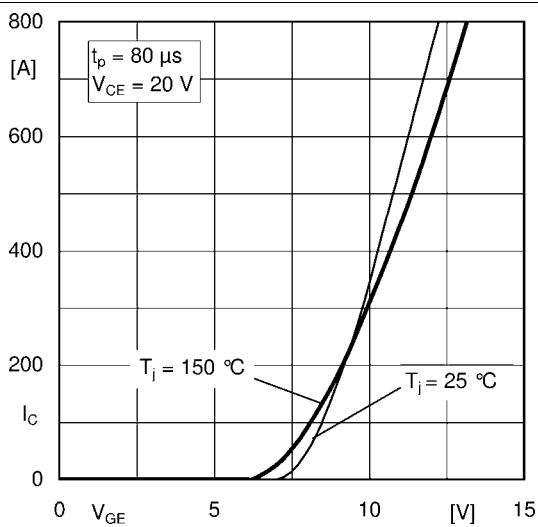

Fig. 5: Typ. transfer characteristic

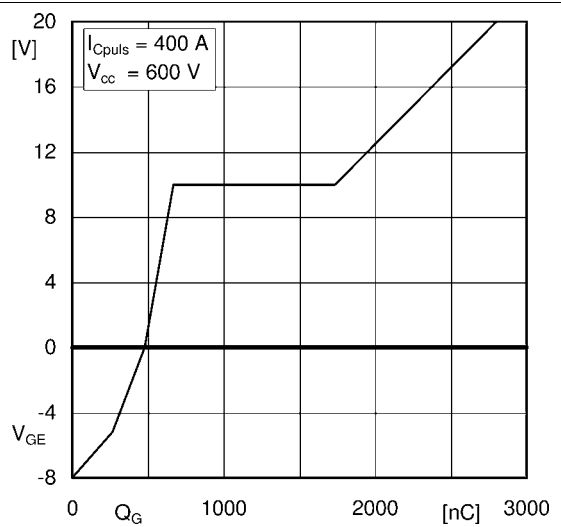

Fig. 6: Typ. gate charge characteristic

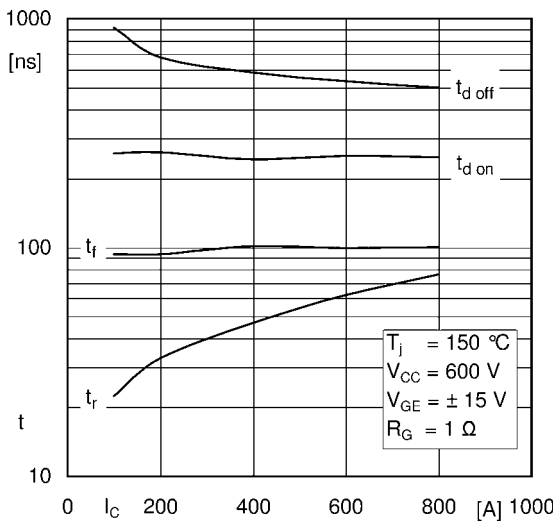

Fig. 7: Typ. switching times vs.  $I_C$

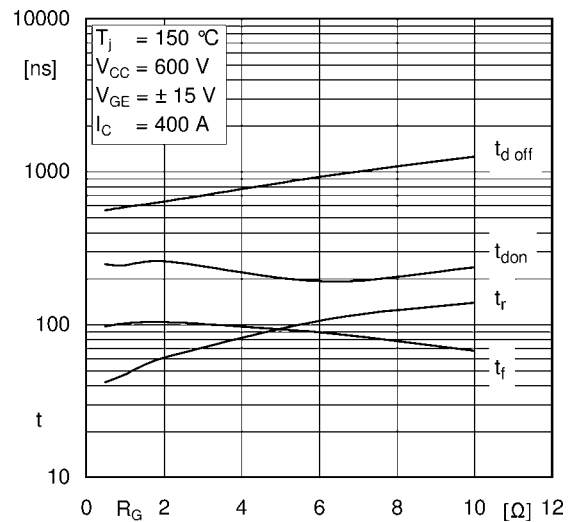

Fig. 8: Typ. switching times vs. gate resistor  $R_G$

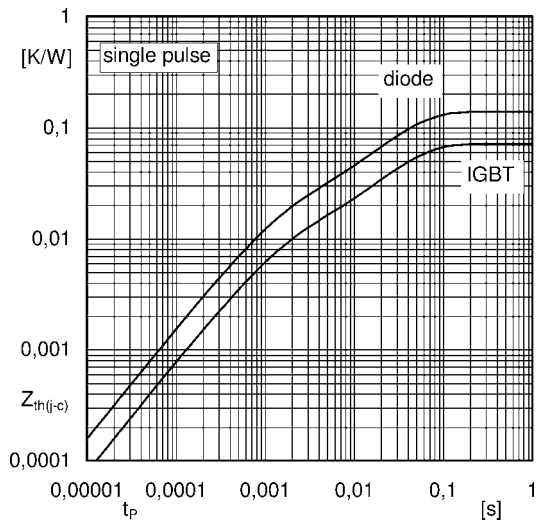

Fig. 9: Transient thermal impedance

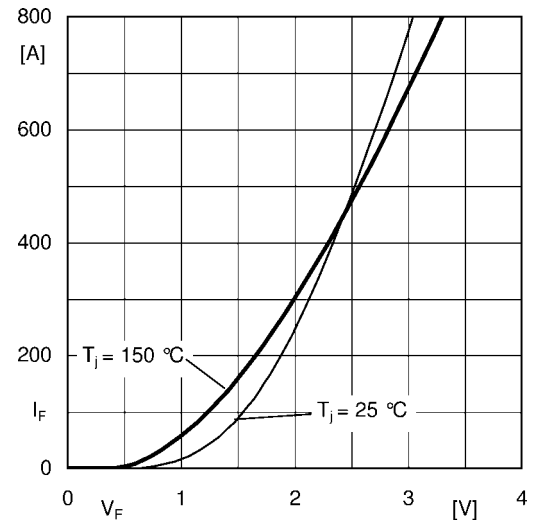

Fig. 10: CAL diode forward characteristic

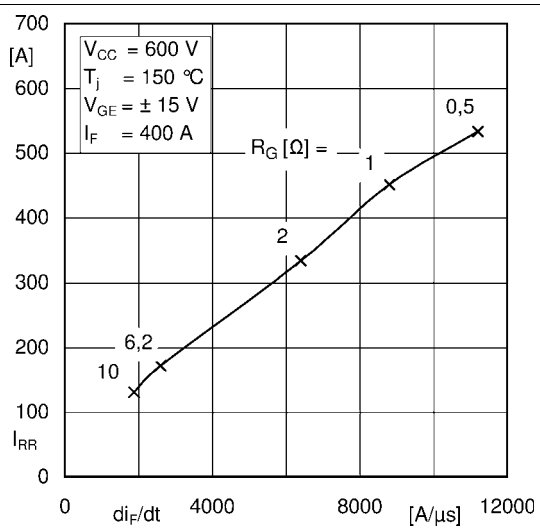

Fig. 11: CAL diode peak reverse recovery current

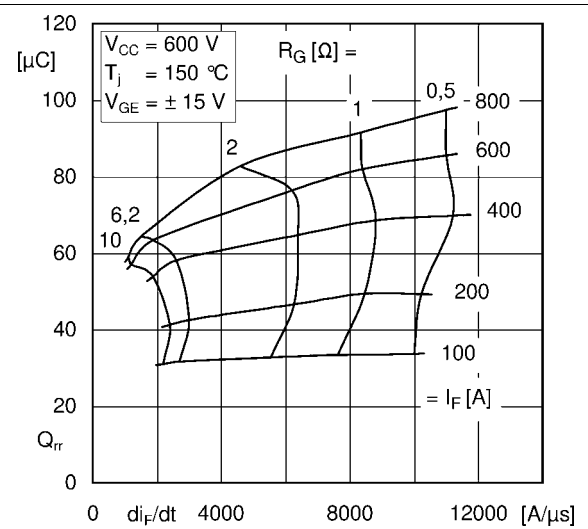
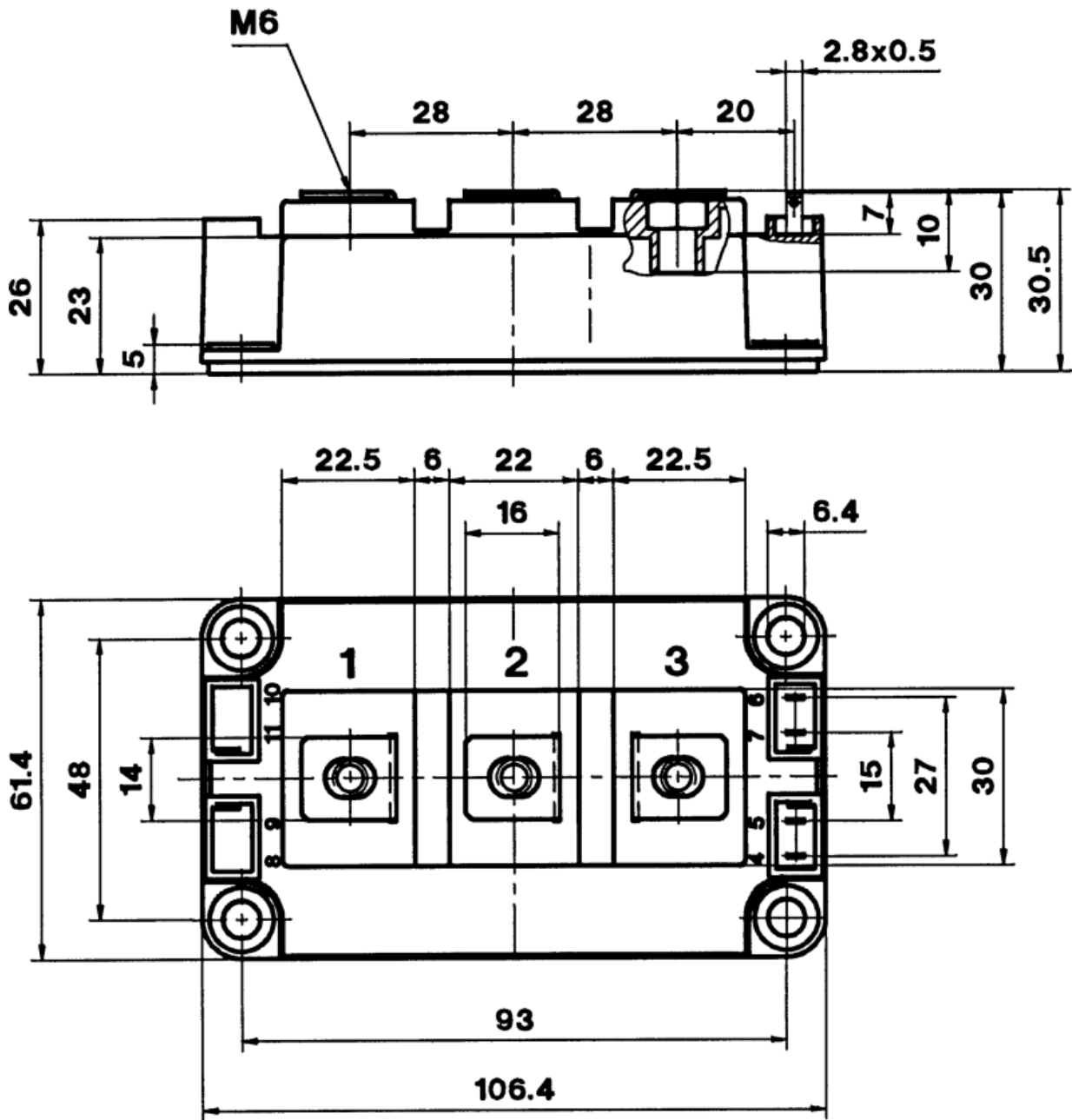
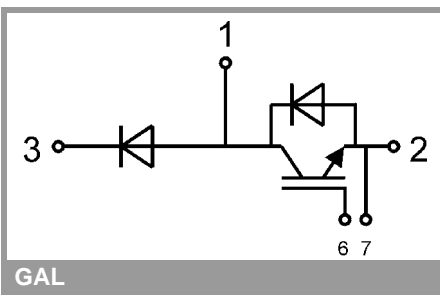

Fig. 12: Typ. CAL diode peak reverse recovery charge



Semitrans 3



GAL

This is an electrostatic discharge sensitive device (ESDS), international standard IEC 60747-1, Chapter IX.

This technical information specifies semiconductor devices but promises no characteristics. No warranty or guarantee expressed or implied is made regarding delivery, performance or suitability.