

SKKT 500, SKKH 500



SEMIPACK[®] 5

Thyristor / Diode Modules

SKKT 500

SKKH 500

Features

- Heat transfer through aluminium nitride ceramic isolated metal baseplate
- Precious metal pressure contacts for high reliability
- UL recognized, file no. E 63 532

Typical Applications

- AC motor softstarters
- Input converters for AC inverter drives
- DC motor control (e. g. for machine tools)
- Temperature control (e. g. for ovens, chemical processes)
- Professional light dimming (studios, theaters)

- 1) See the assembly instructions
- 2) The screws must be lubricated

V_{RSM} V	V_{RRM}, V_{DRM} V	$I_{TRMS} = 920$ A (maximum value for continuous operation) $I_{TAV} = 500$ A (sin. 180; $T_c = 89$ °C)	
900	800	SKKT 500/08E	SKKH 500/08E
1300	1200	SKKT 500/12E	SKKH 500/12E
1500	1400	SKKT 500/14E	SKKH 500/14E
1700	1600	SKKT 500/16E	SKKH 500/16E
1900	1800	SKKT 500/18E	SKKH 500/18E

Symbol	Conditions	Values	Units
I_{TAV}	sin. 180; $T_c = 85$ (100) °C;	540 (390)	A
I_D	P16/200F; $T_a = 35$ °C; B2 / B6	665 / 845	A
I_{RMS}	P16/300F; $T_a = 35$ °C; W1 / W3	850 / 3 * 670	A
I_{TSM}	$T_{vj} = 25$ °C; 10 ms	17000	A
	$T_{vj} = 130$ °C; 10 ms	15000	A
i^2t	$T_{vj} = 25$ °C; 8,3 ... 10 ms	1445000	A ² s
	$T_{vj} = 130$ °C; 8,3 ... 10 ms	1125000	A ² s
V_T	$T_{vj} = 25$ °C; $I_T = 1700$ A	max. 1,5	V
$V_{T(TO)}$	$T_{vj} = 130$ °C	max. 0,925	V
r_T	$T_{vj} = 130$ °C	max. 0,27	mΩ
I_{DD}, I_{RD}	$T_{vj} = 130$ °C; $V_{RD} = V_{RRM}, V_{DD} = V_{DRM}$	max. 100	mA
t_{gd}	$T_{vj} = 25$ °C; $I_G = 1$ A; $di_G/dt = 1$ A/μs	1	μs
t_{gr}	$V_D = 0,67 * V_{DRM}$	2	μs
$(di/dt)_{cr}$	$T_{vj} = 130$ °C	max. 200	A/μs
$(dv/dt)_{cr}$	$T_{vj} = 130$ °C	max. 1000	V/μs
t_q	$T_{vj} = 130$ °C	100 ... 200	μs
I_H	$T_{vj} = 25$ °C; typ. / max.	150 / 500	mA
I_L	$T_{vj} = 25$ °C; $R_G = 33$ Ω; typ. / max.	300 / 2000	mA
V_{GT}	$T_{vj} = 25$ °C; d.c.	min. 3	V
I_{GT}	$T_{vj} = 25$ °C; d.c.	min. 200	mA
V_{GD}	$T_{vj} = 130$ °C; d.c.	max. 0,25	V
I_{GD}	$T_{vj} = 130$ °C; d.c.	max. 10	mA
$R_{th(j-c)}$	cont.; per thyristor / per module	0,062 / 0,031	K/W
$R_{th(j-c)}$	sin. 180; per thyristor / per module	0,065 / 0,032	K/W
$R_{th(j-c)}$	rec. 120; per thyristor / per module	0,07 / 0,035	K/W
$R_{th(c-s)}$	per thyristor / per module	0,02 / 0,01	K/W
T_{vj}		- 40 ... + 130	°C
T_{stg}		- 40 ... + 130	°C
V_{isol}	a. c. 50 Hz; r.m.s.; 1 s / 1 min.	3600 / 3000	V~
M_s	to heatsink	5 ± 15 % ¹⁾	Nm
M_t	to terminals	12 ± 15 % ²⁾	Nm
a		5 * 9,81	m/s ²
m	approx.	1420	g
Case	SKKT	A 60 a	
	SKKH	A 66 a	

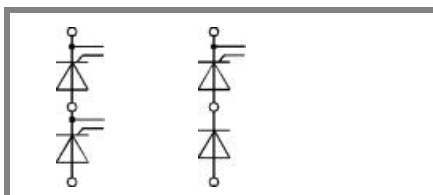

SKKT

SKKH

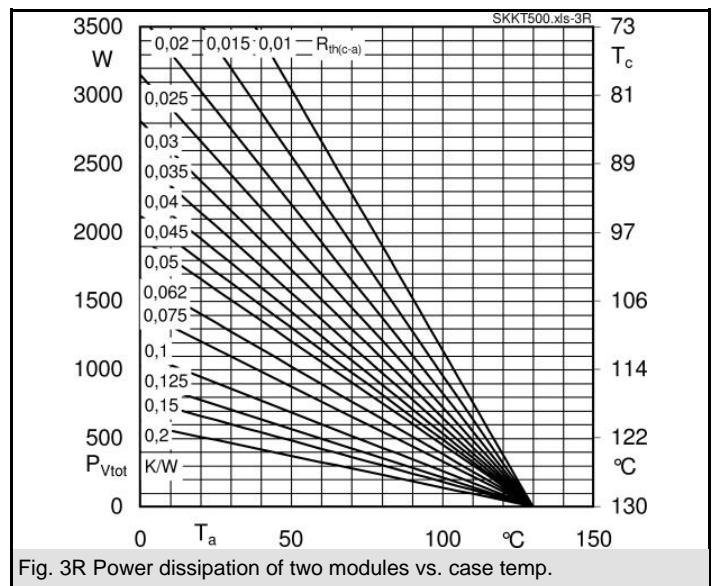
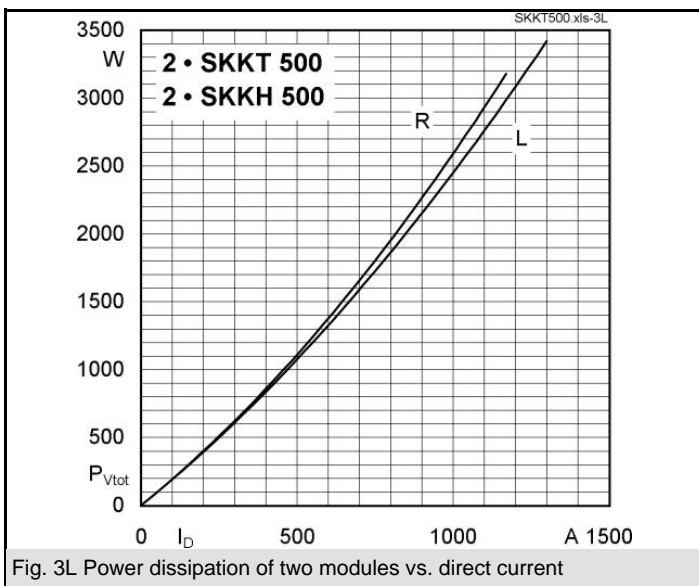
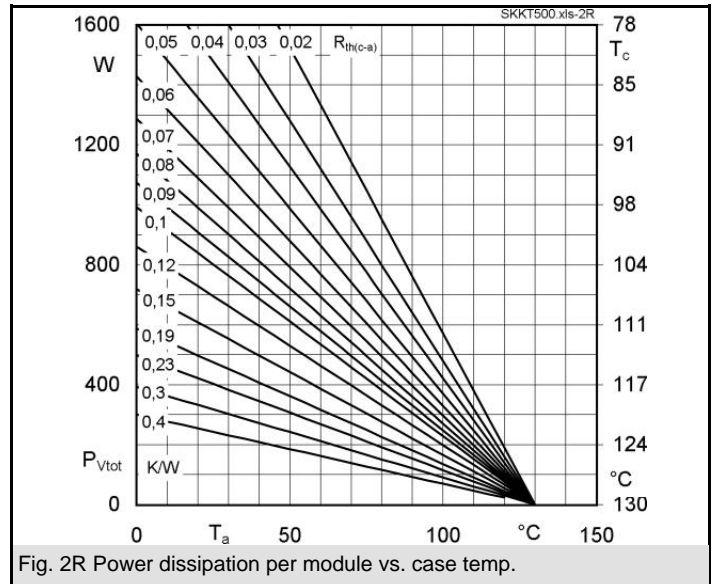
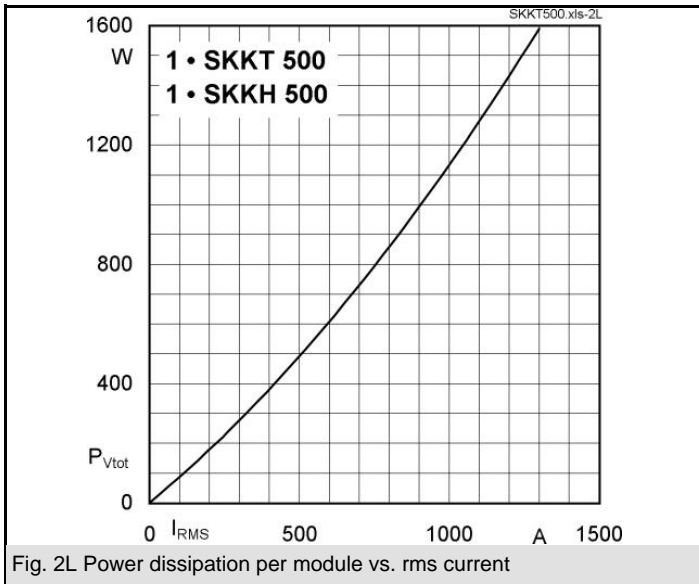
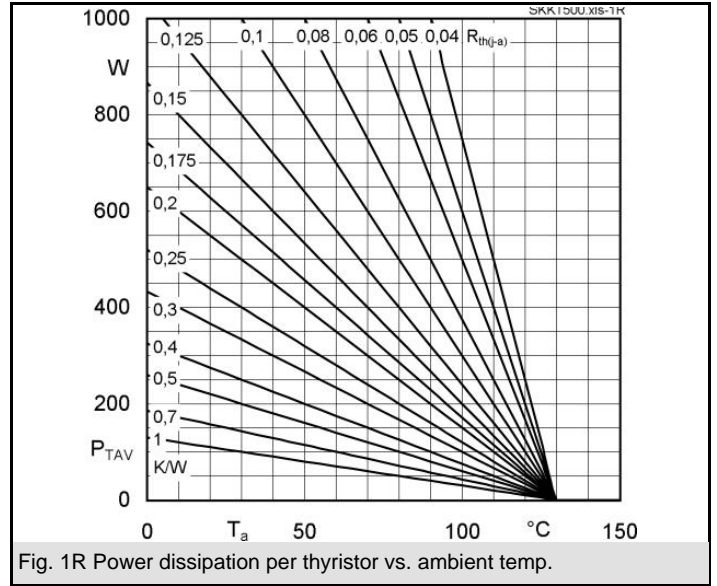
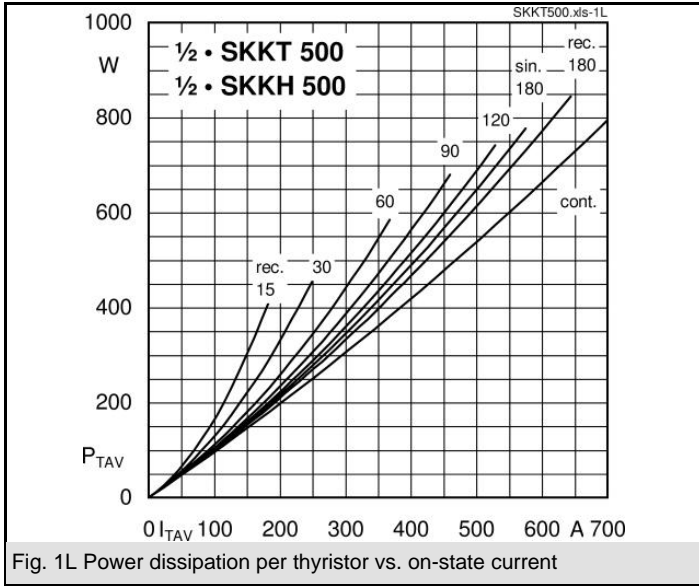

SKKT 500, SKKH 500

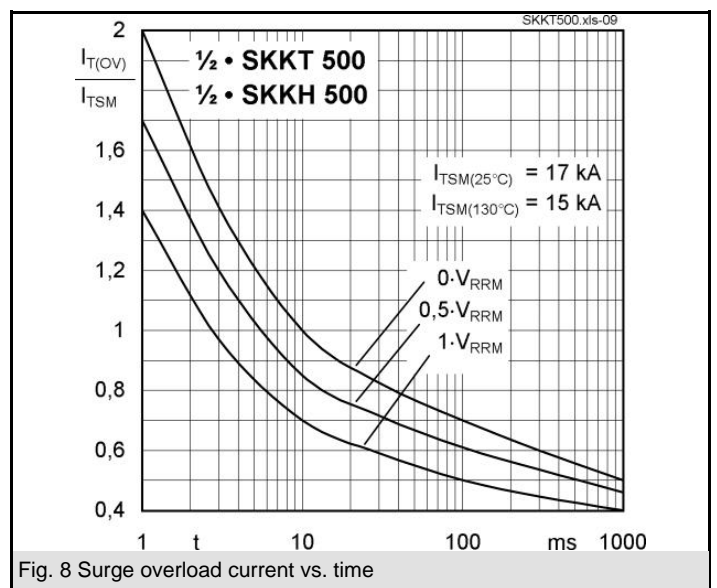
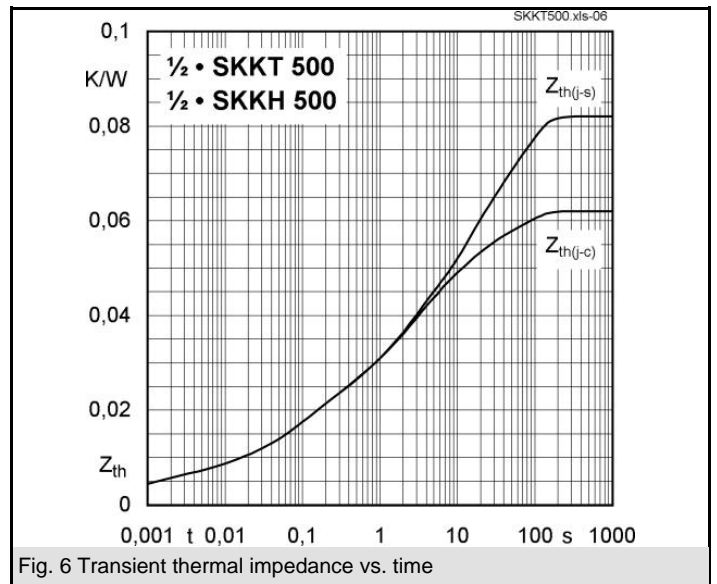
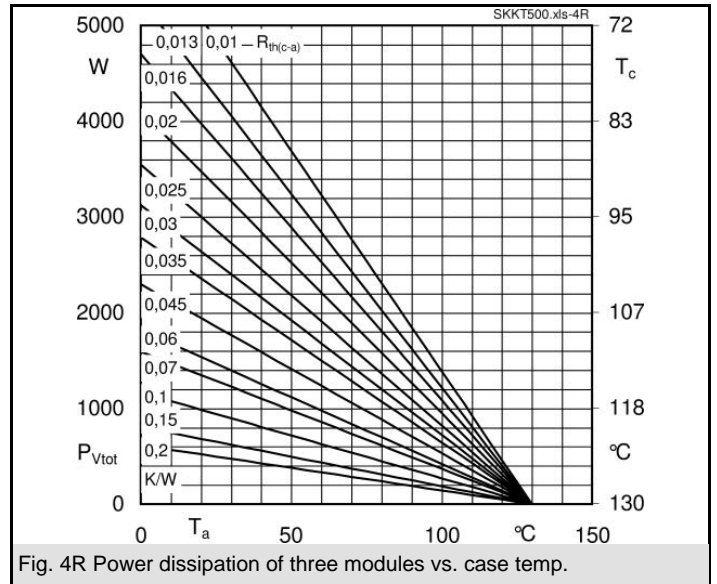
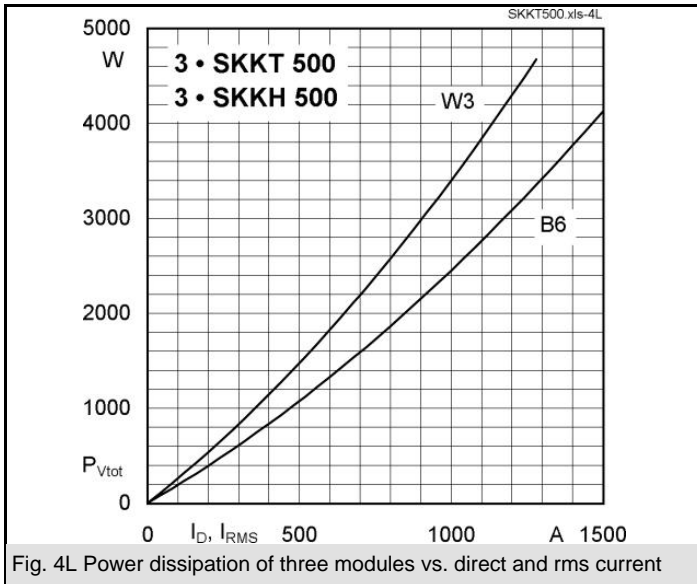

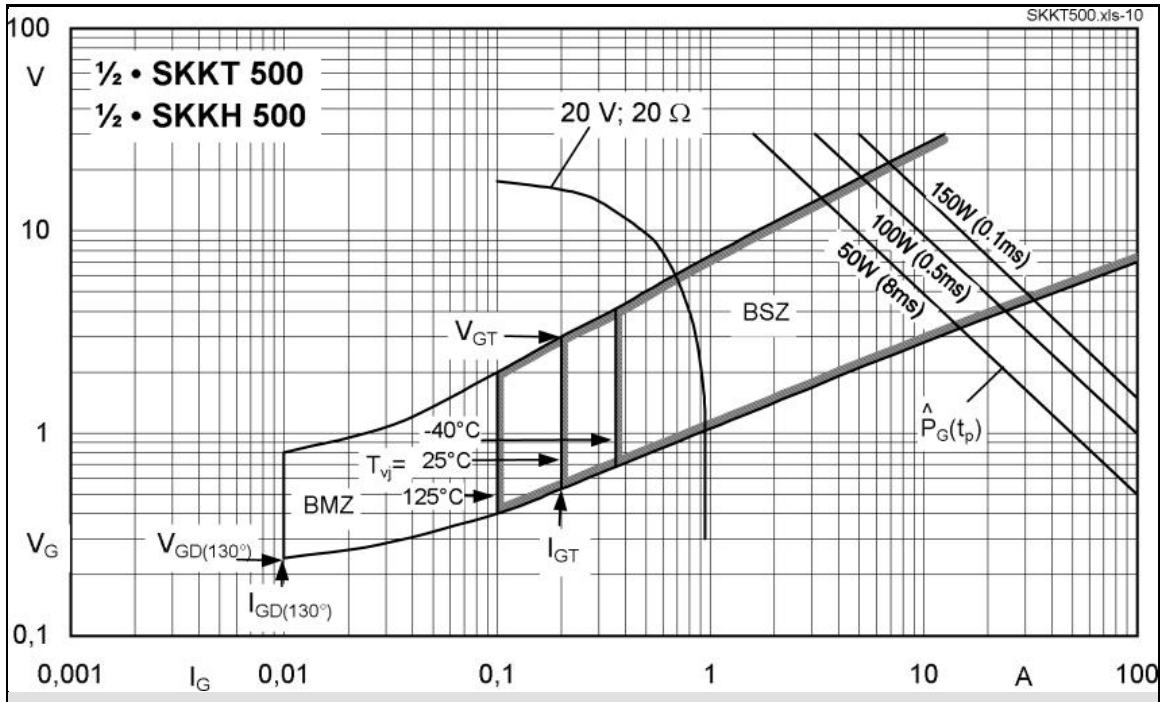
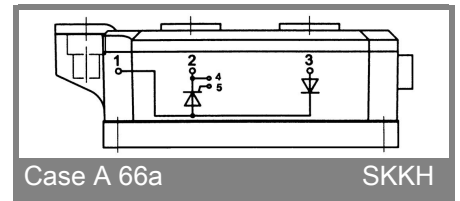
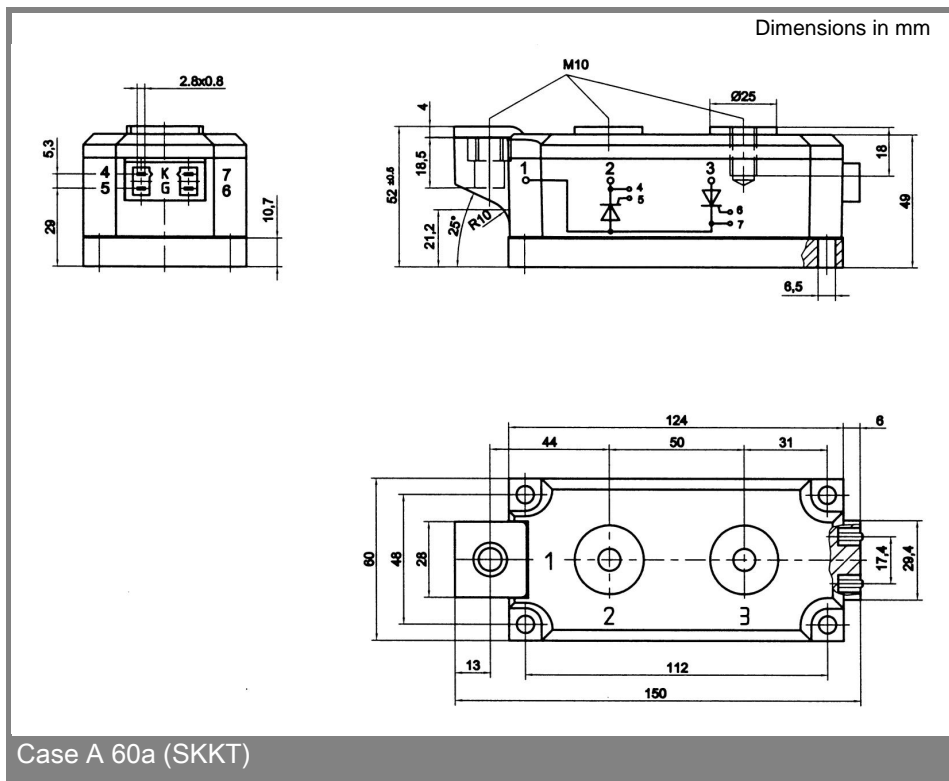

Fig. 9 Gate trigger characteristics



This technical information specifies semiconductor devices but promises no characteristics. No warranty or guarantee expressed or implied is made regarding delivery, performance or suitability.