

# SKKT 42, SKKT 42B, SKKH 42



**SEMIPACK® 1**

## Thyristor / Diode Modules

**SKKT 42**

**SKKT 42B**

**SKKH 42**

### Features

- Heat transfer through aluminium oxide ceramic isolated metal baseplate
- Hard soldered joints for high reliability
- UL recognized, file no. E 63 532

### Typical Applications

- DC motor control (e. g. for machine tools)
- AC motor soft starters
- Temperature control (e. g. for ovens, chemical processes)
- Professional light dimming (studios, theaters)

1) See the assembly instructions

$V_{RSM}$ V	$V_{RRM}, V_{DRM}$ V	$I_{TRMS} = 75$ A (maximum value for continuous operation)		
		$I_{TAV} = 40$ A (sin. 180; $T_c = 85$ °C)		
900	800	SKKT 42/08E	SKKT 42B08E	SKKH 42/08E
1300	1200	SKKT 42/12E	SKKT 42B12E	SKKH 42/12E
1500	1400	SKKT 42/14E	SKKT 42B14E	SKKH 42/14E
1700	1600	SKKT 42/16E	SKKT 42B16E	SKKH 42/16E
1900	1800	SKKT 42/18E	SKKT 42B18E	SKKH 42/18E

Symbol	Conditions	Values	Units
$I_{TAV}$	sin. 180; $T_c = 85$ (100) °C	40 (28)	A
$I_D$	P3/180; $T_a = 45$ °C; B2 / B6	50 / 60	A
	P3/180F; $T_a = 35$ °C; B2 / B6	85 / 110	A
$I_{RMS}$	P3/180F; $T_a = 35$ °C; W1 / W3	110 / 3 * 85	A
$I_{TSM}$	$T_{vj} = 25$ °C; 10 ms	1000	A
	$T_{vj} = 125$ °C; 10 ms	850	A
$i^2t$	$T_{vj} = 25$ °C; 8,3 ... 10 ms	5000	A <sup>2</sup> s
	$T_{vj} = 125$ °C; 8,3 ... 10 ms	3600	A <sup>2</sup> s
$V_T$	$T_{vj} = 25$ °C; $I_T = 200$ A	max. 1,95	V
$V_{T(TO)}$	$T_{vj} = 125$ °C	1	V
$r_T$	$T_{vj} = 125$ °C	4,5	mΩ
$I_{DD}; I_{RD}$	$T_{vj} = 125$ °C; $V_{RD} = V_{RRM}; V_{DD} = V_{DRM}$	max. 15	mA
$t_{gd}$	$T_{vj} = 25$ °C; $I_G = 1$ A; $di_G/dt = 1$ A/μs	1	μs
$t_{gr}$	$V_D = 0,67 * V_{DRM}$	2	μs
$(di/dt)_{cr}$	$T_{vj} = 125$ °C	max. 150	A/μs
$(dv/dt)_{cr}$	$T_{vj} = 125$ °C	max. 1000	V/μs
$t_q$	$T_{vj} = 125$ °C	80	μs
$I_H$	$T_{vj} = 25$ °C; typ. / max.	150 / 250	mA
$I_L$	$T_{vj} = 25$ °C; $R_G = 33$ Ω; typ. / max.	300 / 600	mA
$V_{GT}$	$T_{vj} = 25$ °C; d.c.	min. 3	V
$I_{GT}$	$T_{vj} = 25$ °C; d.c.	min. 150	mA
$V_{GD}$	$T_{vj} = 125$ °C; d.c.	max. 0,25	V
$I_{GD}$	$T_{vj} = 125$ °C; d.c.	max. 6	mA
$R_{th(j-c)}$	cont.; per thyristor / per module	0,65 / 0,33	K/W
$R_{th(j-c)}$	sin. 180; per thyristor / per module	0,69 / 0,35	K/W
$R_{th(j-c)}$	rec. 120; per thyristor / per module	0,73 / 0,37	K/W
$R_{th(c-s)}$	per thyristor / per module	0,2 / 0,1	K/W
$T_{vj}$		- 40 ... + 125	°C
$T_{stg}$		- 40 ... + 125	°C
$V_{isol}$	a. c. 50 Hz; r.m.s.; 1 s / 1 min.	3600 / 3000	V~
$M_s$	to heatsink	5 ± 15 % <sup>1)</sup>	Nm
$M_t$	to terminals	3 ± 15 %	Nm
$a$		5 * 9,81	m/s <sup>2</sup>
$m$	approx.	95	g
Case	SKKT	A 46	
	SKKT ...B	A 48	
	SKKH	A 47	

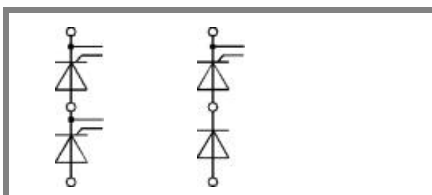

SKKT

SKKH

# SKKT 42, SKKT 42B, SKKH 42

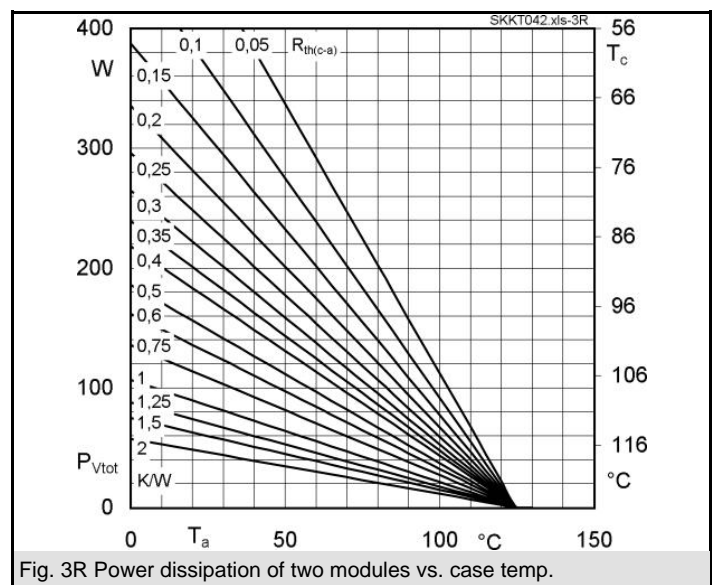
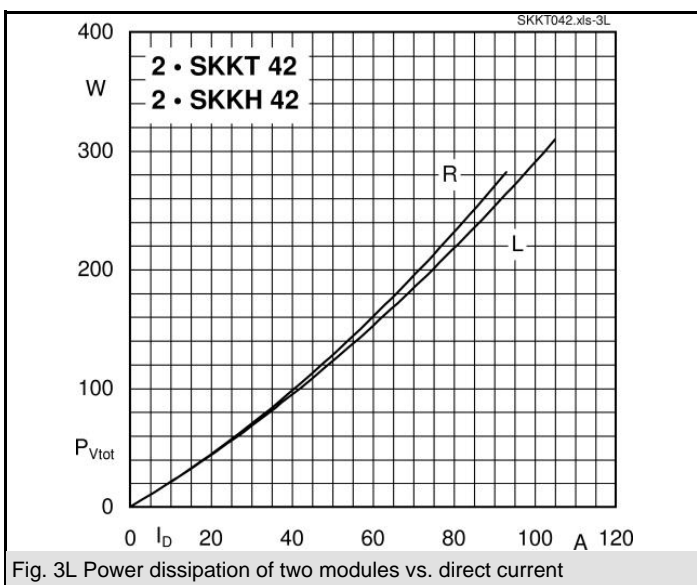
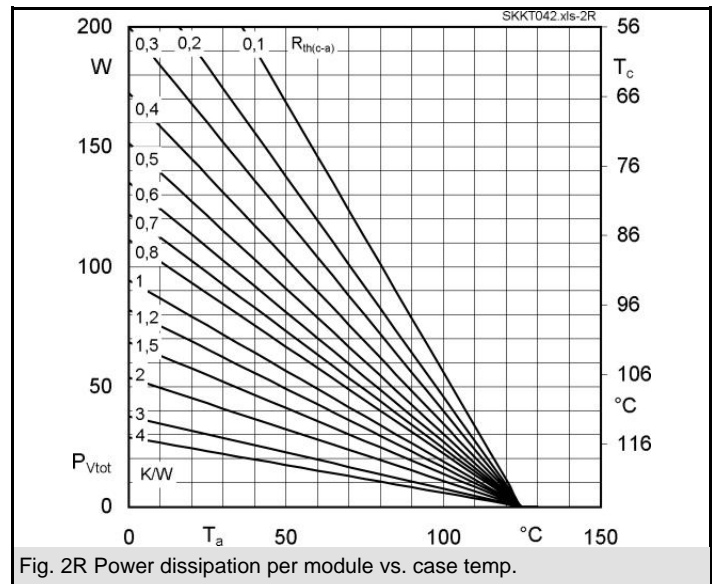
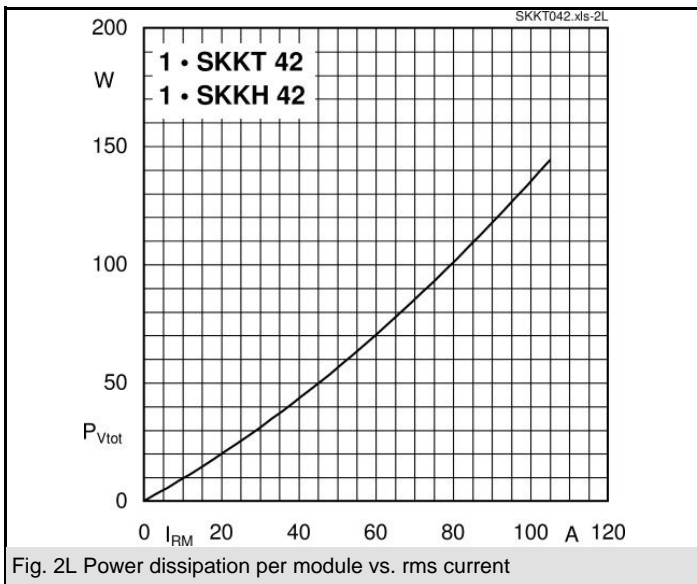
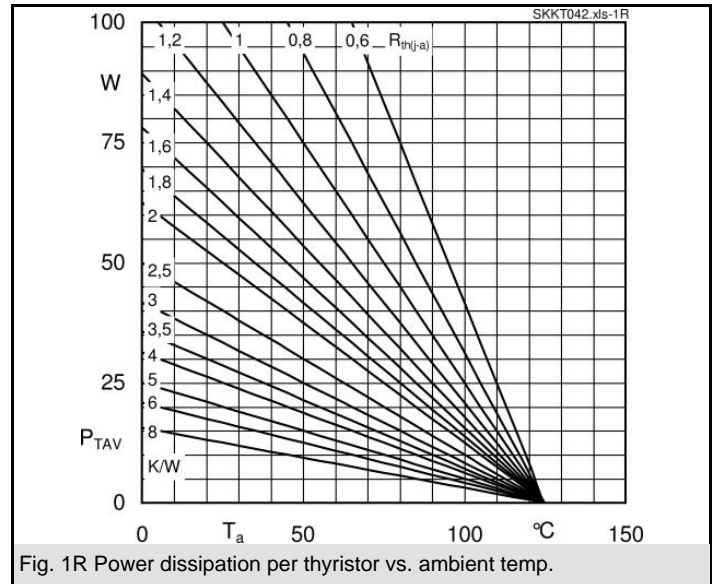
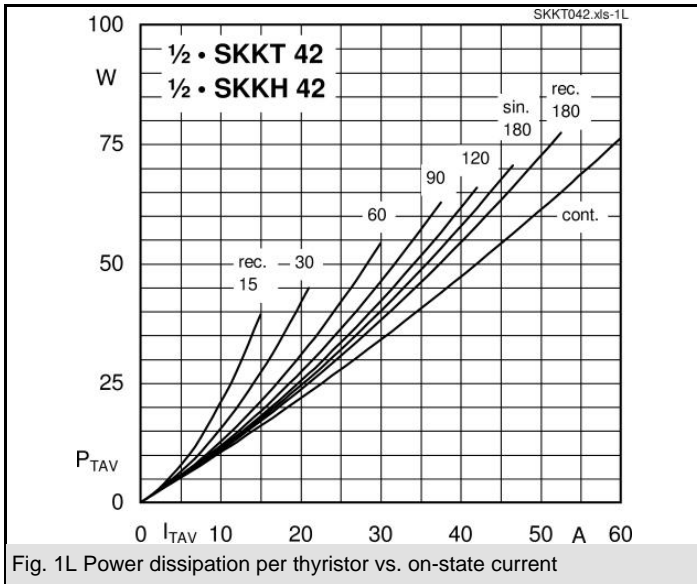

# SKKT 42, SKKT 42B, SKKH 42

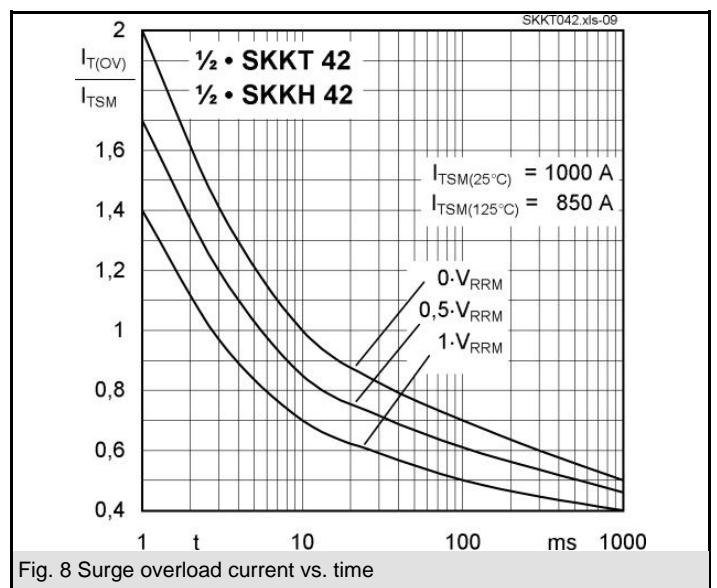
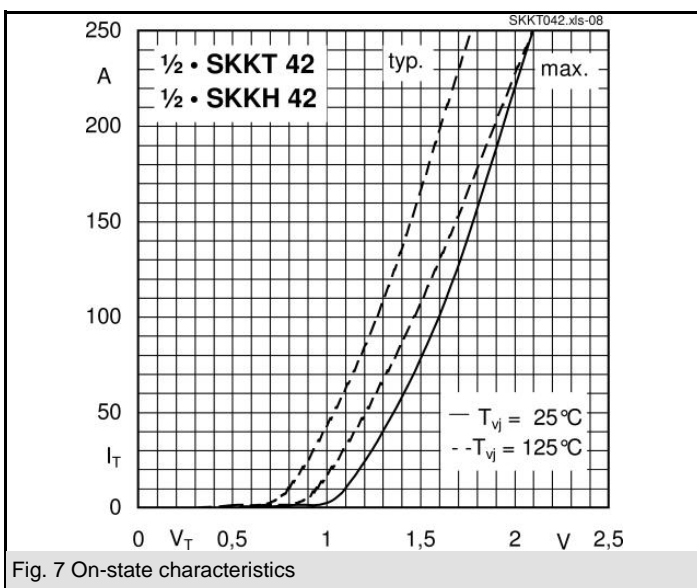
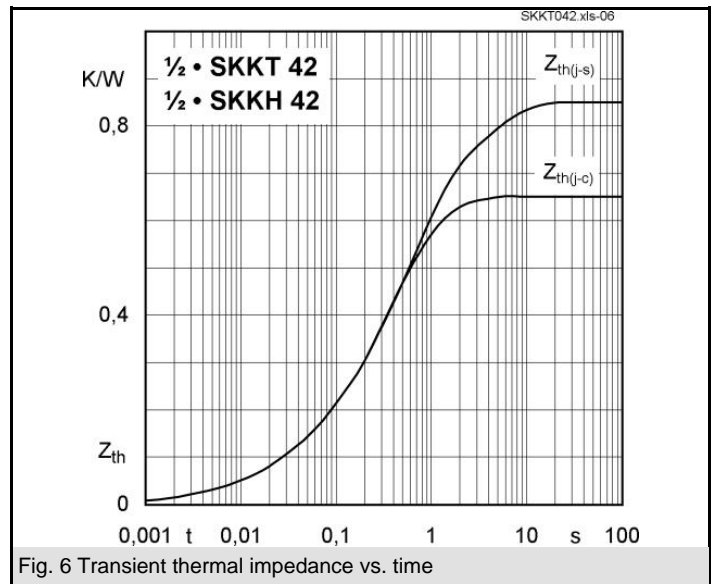
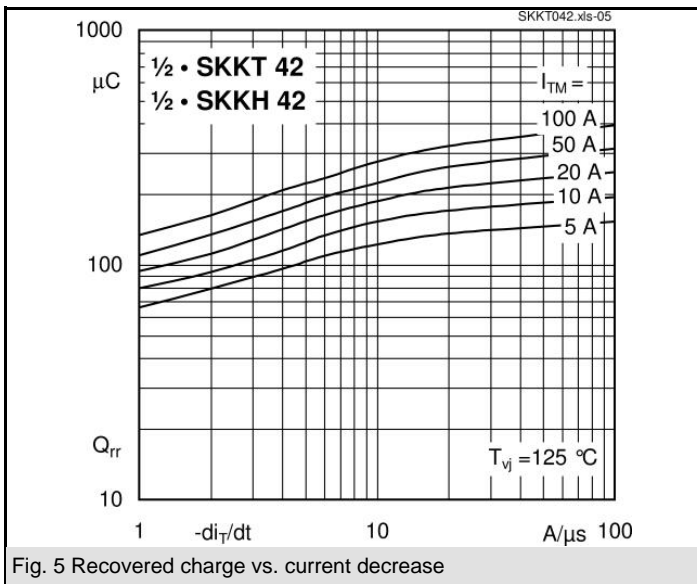
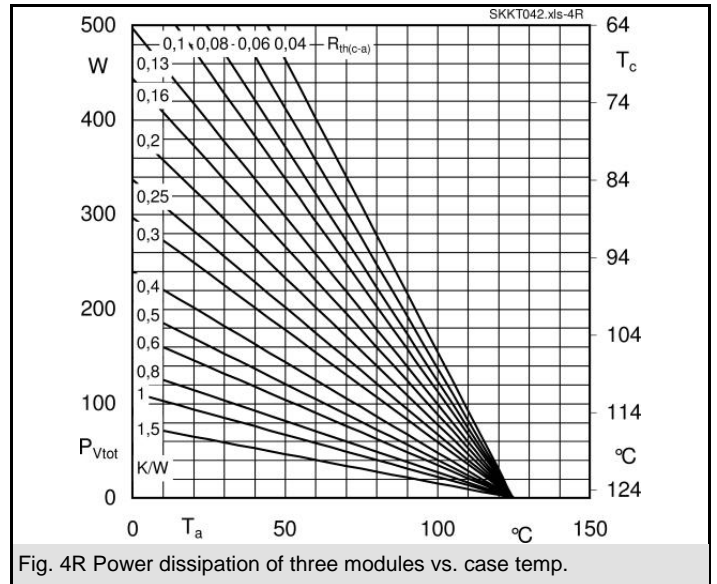
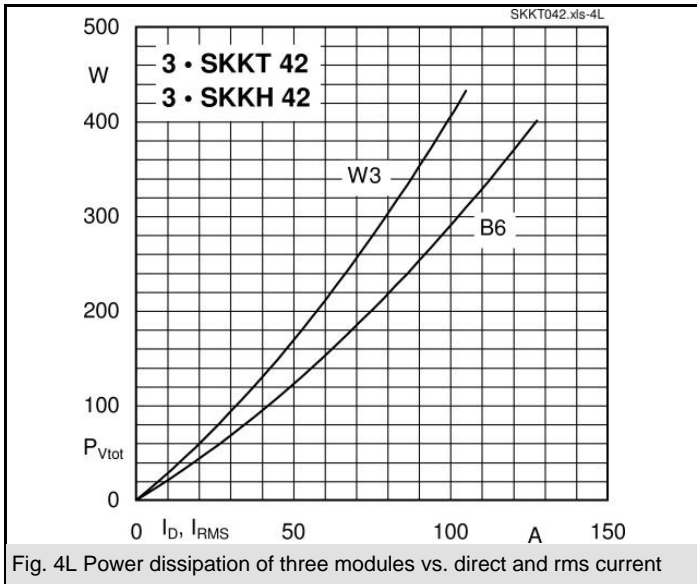

# SKKT 42, SKKT 42B, SKKH 42

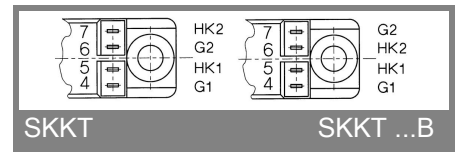
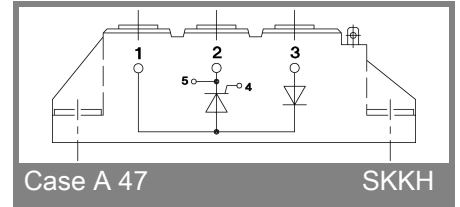
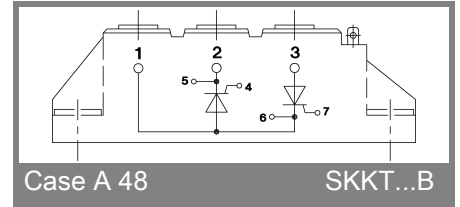
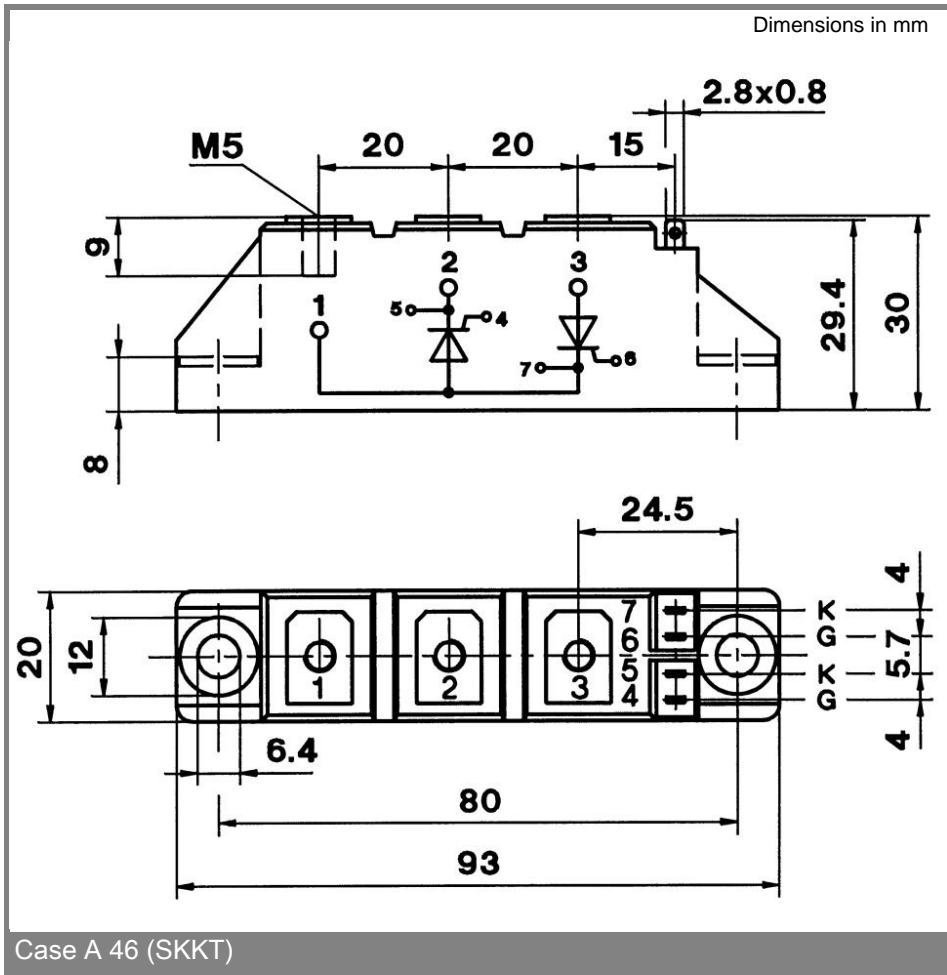

This technical information specifies semiconductor devices but promises no characteristics. No warranty or guarantee expressed or implied is made regarding delivery, performance or suitability.