

SKKT 42, SKKT 42B, SKKH 42



SEMIPACK[®] 1

Thyristor / Diode Modules

SKKT 42

SKKT 42B

SKKH 42

Features

- Heat transfer through aluminium oxide ceramic isolated metal baseplate
- Hard soldered joints for high reliability
- UL recognized, file no. E 63 532

Typical Applications

- DC motor control (e. g. for machine tools)
- AC motor soft starters
- Temperature control (e. g. for ovens, chemical processes)
- Professional light dimming (studios, theaters)

1) See the assembly instructions

V_{RSM} V	V_{RRM}, V_{DRM} V	$I_{TRMS} = 75$ A (maximum value for continuous operation)		
		$I_{TAV} = 40$ A (sin. 180; $T_c = 85$ °C)		
900	800	SKKT 42/08E	SKKT 42B08E	SKKH 42/08E
1300	1200	SKKT 42/12E	SKKT 42B12E	SKKH 42/12E
1500	1400	SKKT 42/14E	SKKT 42B14E	SKKH 42/14E
1700	1600	SKKT 42/16E	SKKT 42B16E	SKKH 42/16E
1900	1800	SKKT 42/18E	SKKT 42B18E	SKKH 42/18E

Symbol	Conditions	Values	Units
I_{TAV}	sin. 180; $T_c = 85$ (100) °C	40 (28)	A
I_D	P3/180; $T_a = 45$ °C; B2 / B6	50 / 60	A
	P3/180F; $T_a = 35$ °C; B2 / B6	85 / 110	A
I_{RMS}	P3/180F; $T_a = 35$ °C; W1 / W3	110 / 3 * 85	A
I_{TSM}	$T_{vj} = 25$ °C; 10 ms	1000	A
	$T_{vj} = 125$ °C; 10 ms	850	A
i^2t	$T_{vj} = 25$ °C; 8,3 ... 10 ms	5000	A ² s
	$T_{vj} = 125$ °C; 8,3 ... 10 ms	3600	A ² s
V_T	$T_{vj} = 25$ °C; $I_T = 200$ A	max. 1,95	V
$V_{T(TO)}$	$T_{vj} = 125$ °C	1	V
r_T	$T_{vj} = 125$ °C	4,5	mΩ
$I_{DD}; I_{RD}$	$T_{vj} = 125$ °C; $V_{RD} = V_{RRM}; V_{DD} = V_{DRM}$	max. 15	mA
t_{gd}	$T_{vj} = 25$ °C; $I_G = 1$ A; $di_G/dt = 1$ A/μs	1	μs
t_{gr}	$V_D = 0,67 * V_{DRM}$	2	μs
$(di/dt)_{cr}$	$T_{vj} = 125$ °C	max. 150	A/μs
$(dv/dt)_{cr}$	$T_{vj} = 125$ °C	max. 1000	V/μs
t_q	$T_{vj} = 125$ °C	80	μs
I_H	$T_{vj} = 25$ °C; typ. / max.	150 / 250	mA
I_L	$T_{vj} = 25$ °C; $R_G = 33$ Ω; typ. / max.	300 / 600	mA
V_{GT}	$T_{vj} = 25$ °C; d.c.	min. 3	V
I_{GT}	$T_{vj} = 25$ °C; d.c.	min. 150	mA
V_{GD}	$T_{vj} = 125$ °C; d.c.	max. 0,25	V
I_{GD}	$T_{vj} = 125$ °C; d.c.	max. 6	mA
$R_{th(j-c)}$	cont.; per thyristor / per module	0,65 / 0,33	K/W
$R_{th(j-c)}$	sin. 180; per thyristor / per module	0,69 / 0,35	K/W
$R_{th(j-c)}$	rec. 120; per thyristor / per module	0,73 / 0,37	K/W
$R_{th(c-s)}$	per thyristor / per module	0,2 / 0,1	K/W
T_{vj}		- 40 ... + 125	°C
T_{stg}		- 40 ... + 125	°C
V_{isol}	a. c. 50 Hz; r.m.s.; 1 s / 1 min.	3600 / 3000	V~
M_s	to heatsink	5 ± 15 % ¹⁾	Nm
M_t	to terminals	3 ± 15 %	Nm
a		5 * 9,81	m/s ²
m	approx.	95	g
Case	SKKT	A 46	
	SKKT ...B	A 48	
	SKKH	A 47	



SKKT

SKKH

SKKT 42, SKKT 42B, SKKH 42

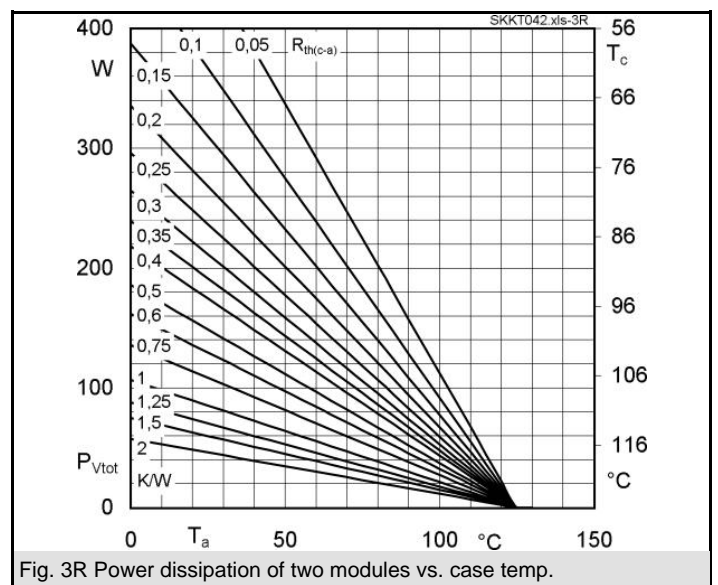
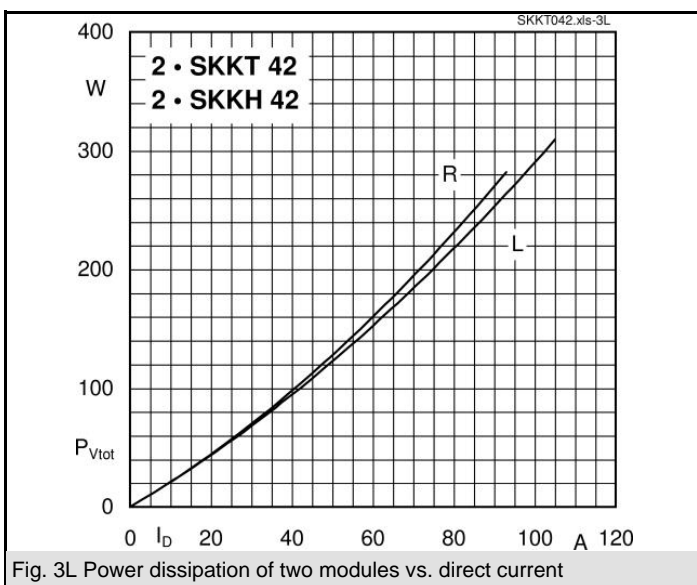
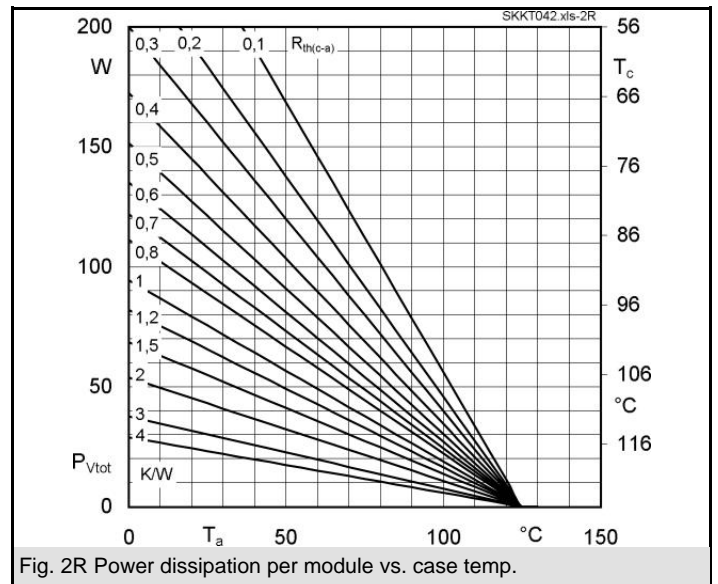
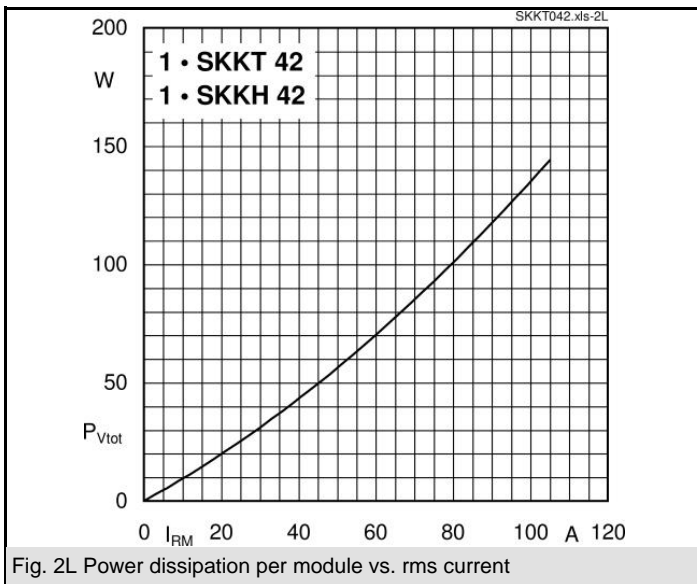
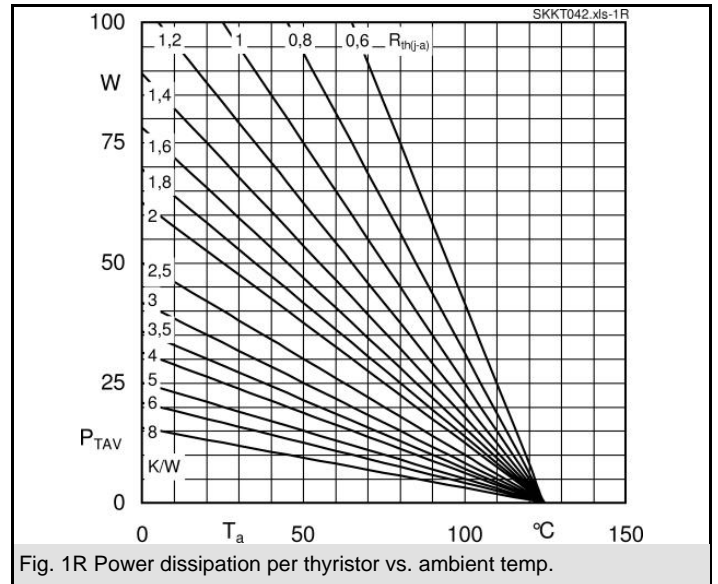
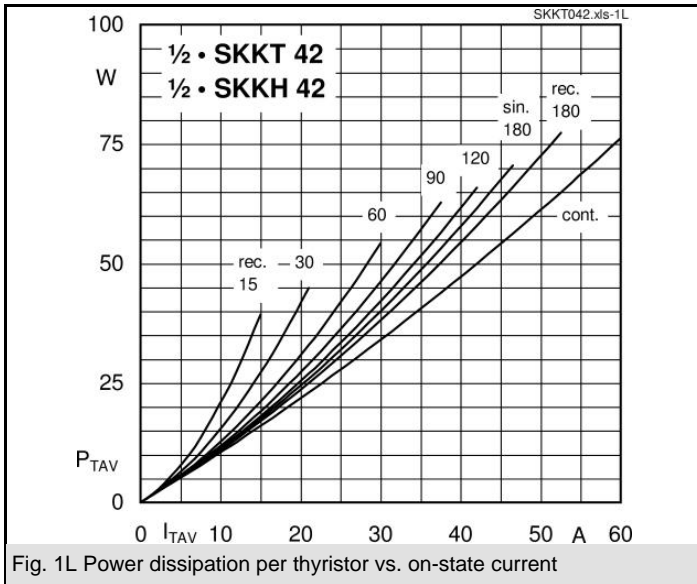

SKKT 42, SKKT 42B, SKKH 42

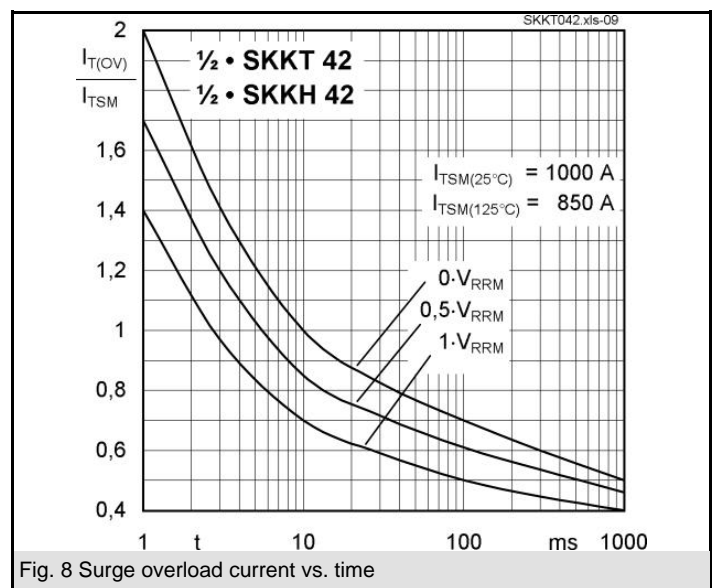
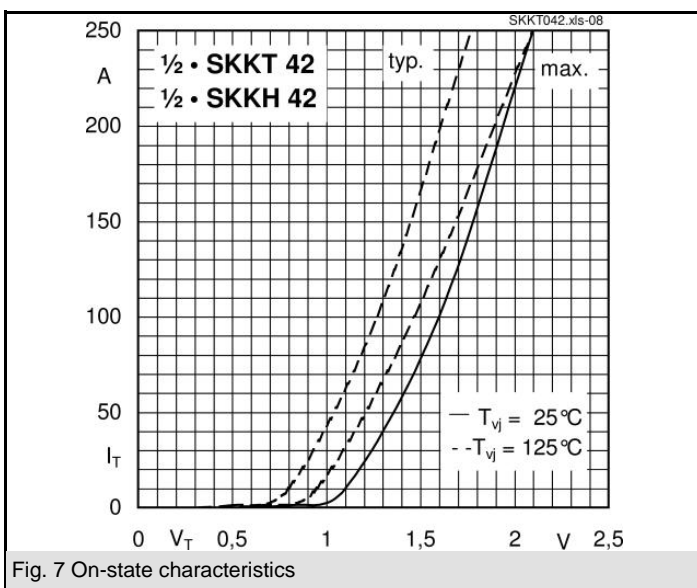
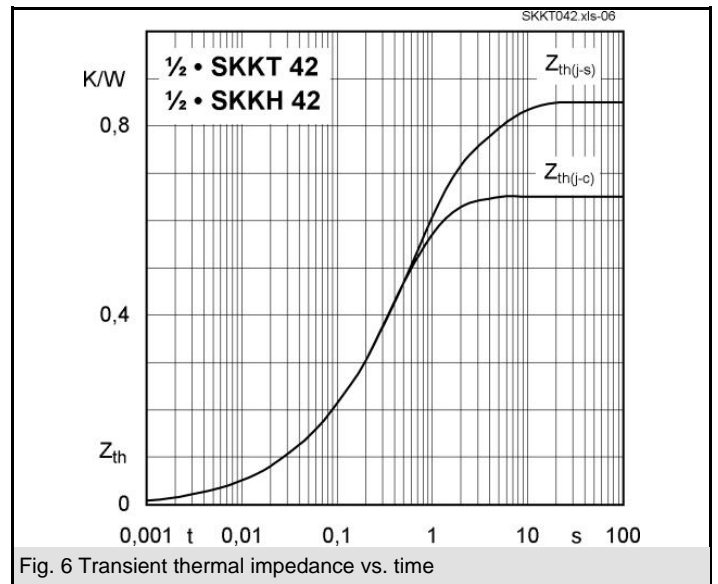
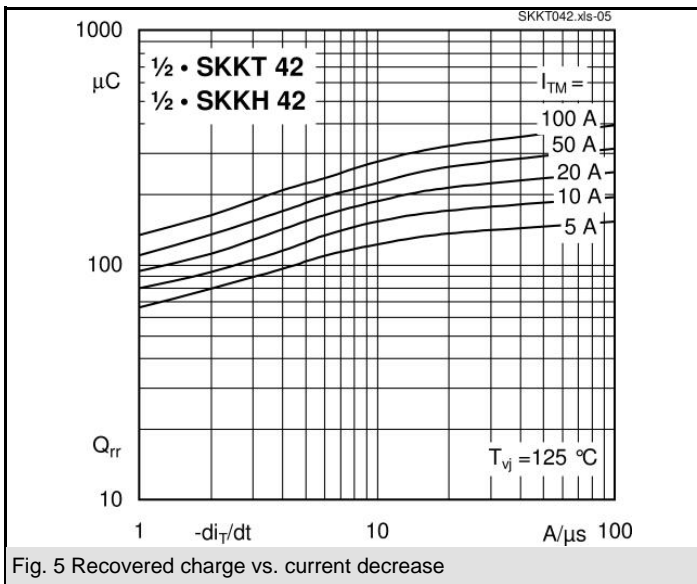
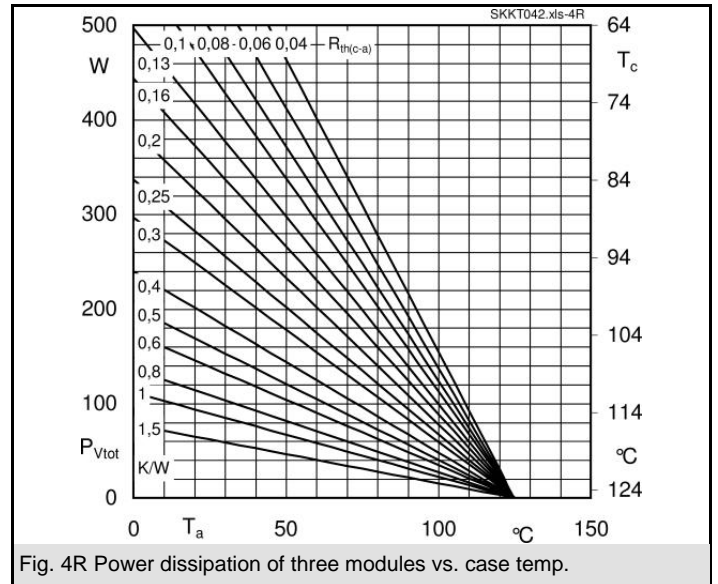
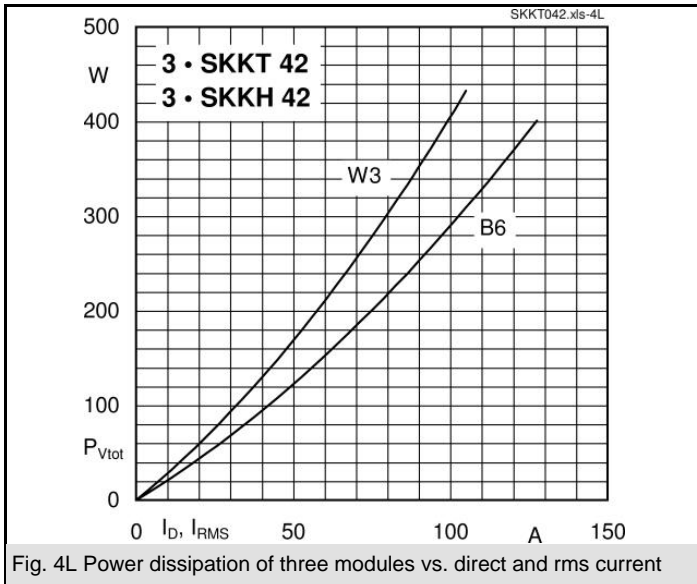

SKKT 42, SKKT 42B, SKKH 42

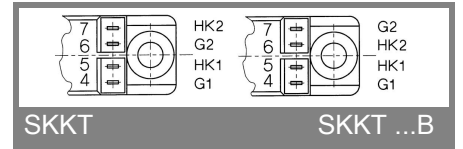
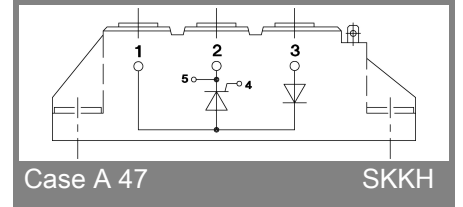
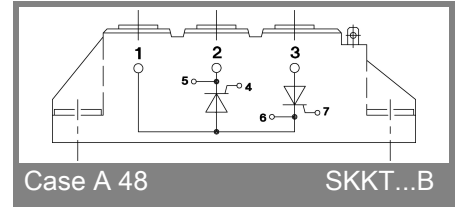
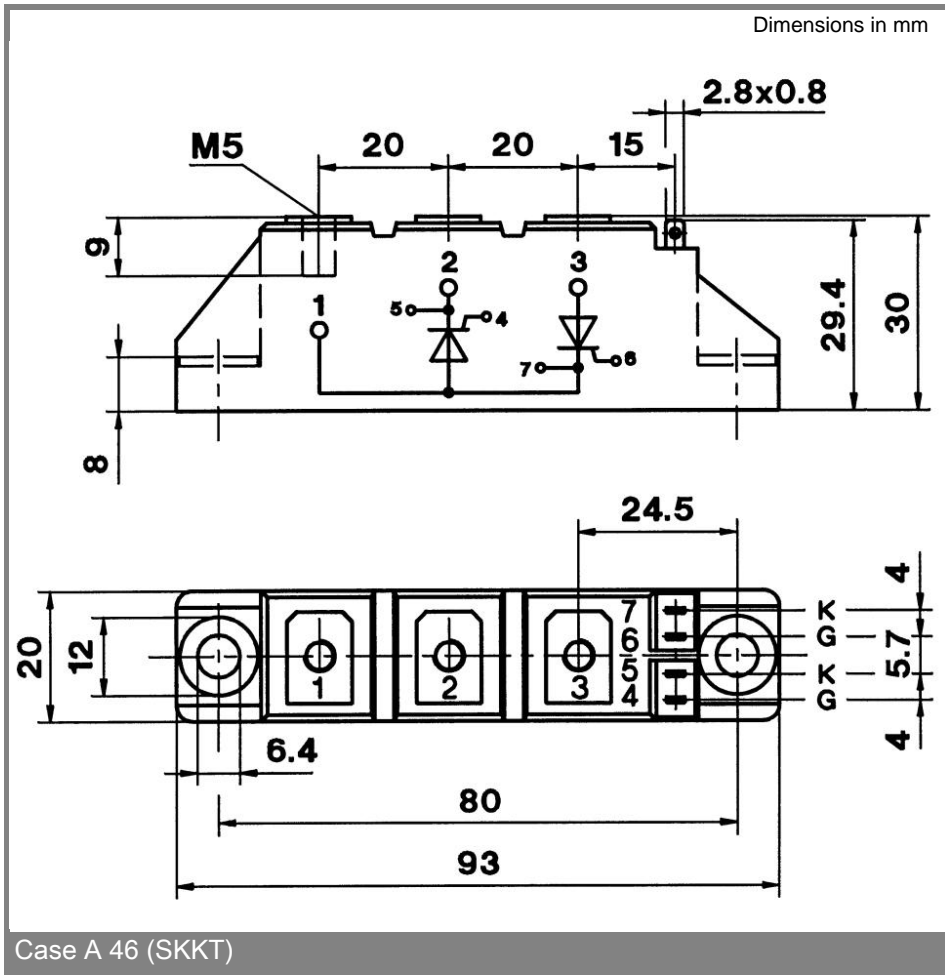

This technical information specifies semiconductor devices but promises no characteristics. No warranty or guarantee expressed or implied is made regarding delivery, performance or suitability.