

# SKKD 42F, SKMD 42F, SKND 42F

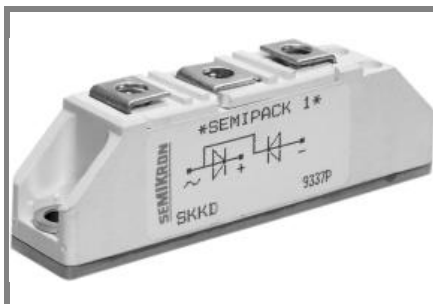

## SEMIPACK<sup>®</sup> 1

### Fast Diode Modules

**SKKD 42F**

**SKMD 42F**

**SKND 42F**

### Features

- Heat transfer through ceramic isolated metal baseplate
- Hard soldered joints for high reliability
- SKKD half bridge connection; SKMD common cathode; SKND common anode
- UL recognized, file no. E 63 532

### Typical Applications\*

- Self-commutated inverters
- DC choppers
- AC motor speed control
- Inductive heating
- Uninterruptible power supplies
- Electronic welders
- General power switching applications

$V_{RSM}$ V	$V_{RRM}$ V	$I_{FRMS} = 120$ A (maximum value for continuous operation)		
		$I_{FAV} = 42$ A (sin. 180; 50 Hz; $T_c = 85$ °C)		
1000	1000	SKKD 42F10	SKMD 42F10	
1200	1200	SKKD 42F12	SKMD 42F12	SKND 42F12
1400	1400	SKKD 42F14	SKMD 42F14	SKND 42F14
1500	1500	SKKD 42F15	SKMD 42F15	SKKD 42F15

Symbol	Conditions	Values	Units
$I_{FAV}$	sin. 180; $T_c = 85$ (100) °C	42 (31)	A
$I_{FSM}$	$T_{vj} = 25$ °C; 10 ms	1200	A
	$T_{vj} = 130$ °C; 10 ms	1100	A
$i^2t$	$T_{vj} = 25$ °C; 8,3 ... 10 ms	7200	A <sup>2</sup> s
	$T_{vj} = 130$ °C; 8,3 ... 10 ms	6000	A <sup>2</sup> s
$V_F$	$T_{vj} = 25$ °C; $I_F = 150$ A	max. 1,85	V
$V_{(TO)}$	$T_{vj} = 130$ °C	max. 1	V
$r_T$	$T_{vj} = 130$ °C	max. 5	mΩ
$I_{RD}$	$T_{vj} = 25$ °C; $V_{RD} = V_{RRM}$	max. 0,4	mA
$I_{RD}$	$T_{vj} = 130$ °C; $V_{RD} = V_{RRM}$	max. 30	mA
$Q_{rr}$	$T_{vj} = 130$ °C; $I_F = 50$ A,	75	μC
$I_{RM}$	$-di/dt = 50$ A/μs, $V_R = 30$ V	70	A
$t_{rr}$		2140	ns
$E_{rr}$		1,12	mJ
$R_{th(j-c)}$	per diode / per module	0,7 / 0,35	K/W
$R_{th(c-s)}$	per diode / per module	0,2 / 0,1	K/W
$T_{vj}$		- 40 ... + 130	°C
$T_{stg}$		- 40 ... + 125	°C
$V_{isol}$	a. c. 50 Hz; r.m.s.; 1 s / 1 min.	3600 / 3000	V~
$M_s$	to heatsink	5 ± 15 %	Nm
$M_t$	to terminals	3 ± 15 %	Nm
$a$		5 * 9,81	m/s <sup>2</sup>
$m$	approx.	120	g
Case	SKKD	A 10	
	SKMD	A 33	
	SKND	A 37	

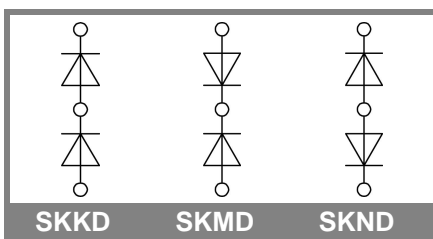

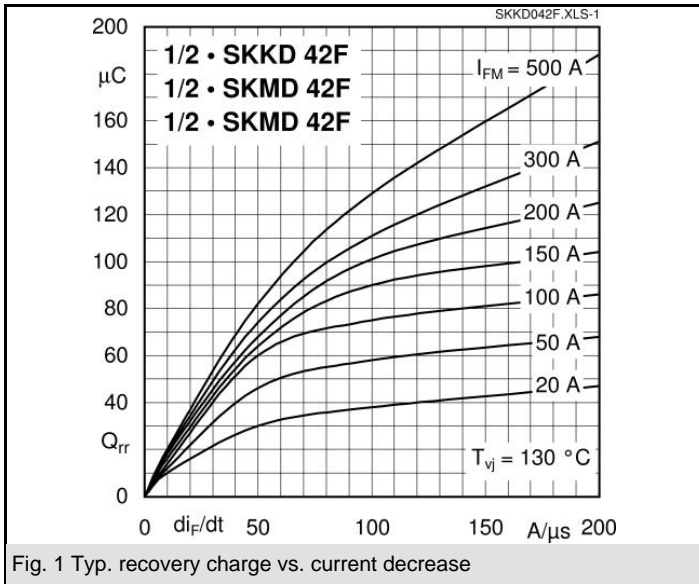

Fig. 1 Typ. recovery charge vs. current decrease

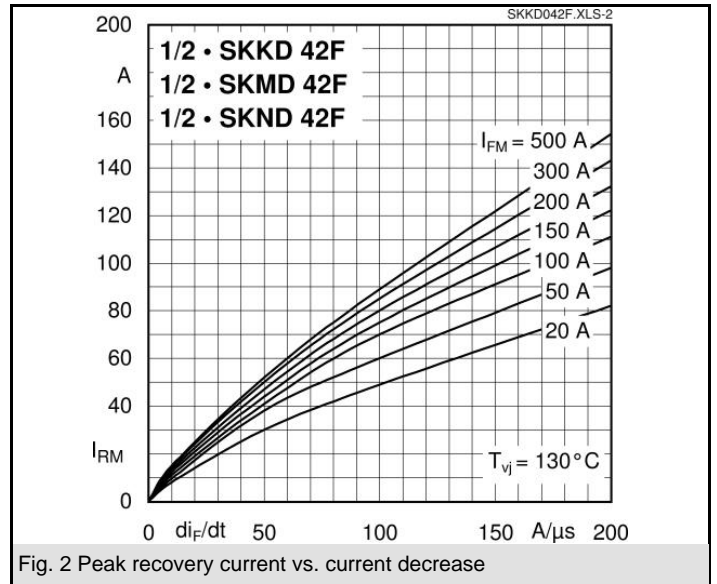

Fig. 2 Peak recovery current vs. current decrease

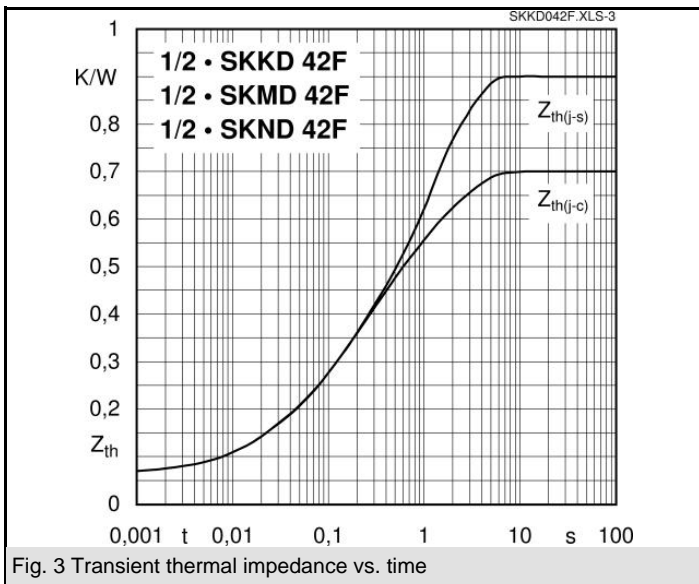

Fig. 3 Transient thermal impedance vs. time

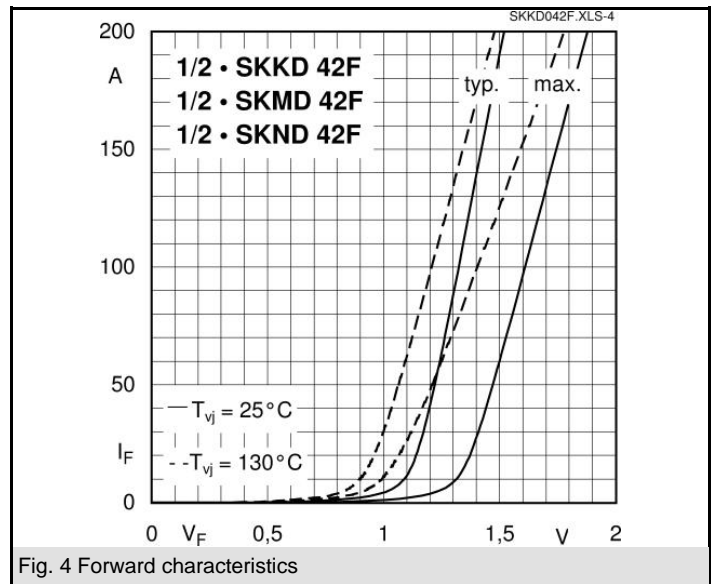

Fig. 4 Forward characteristics

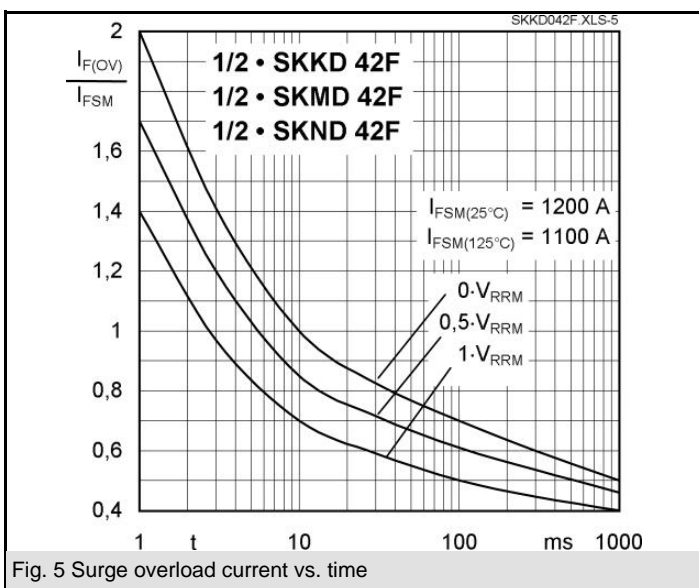
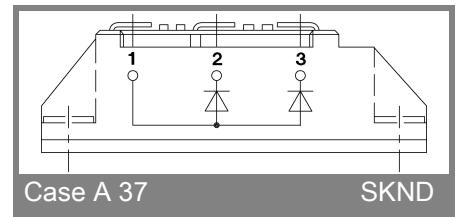
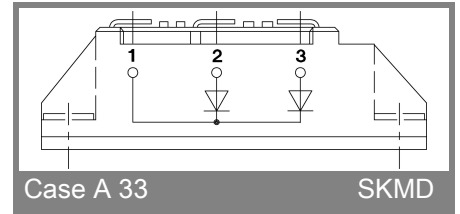
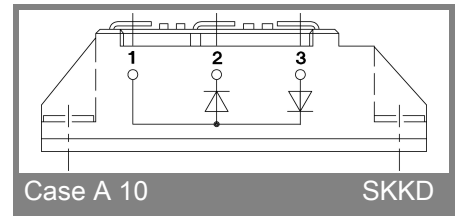
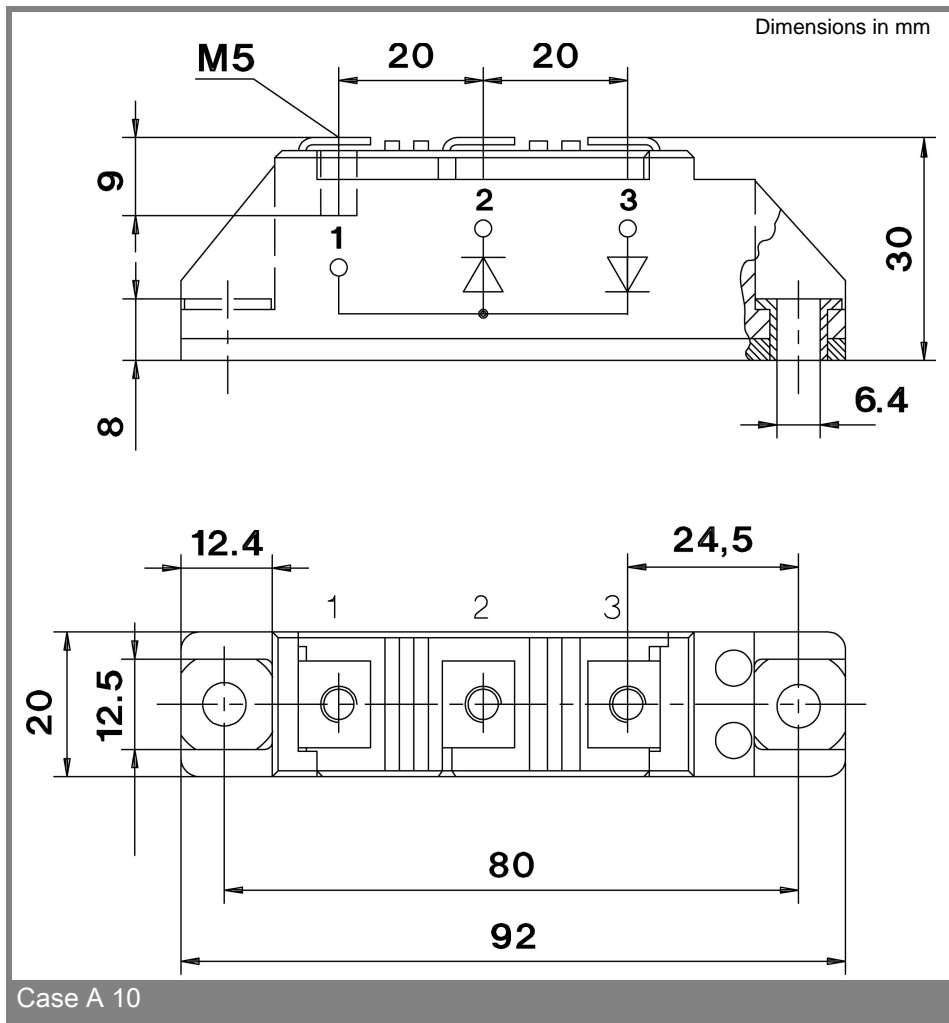

Fig. 5 Surge overload current vs. time

# SKKD 42F, SKMD 42F, SKND 42F



\* The specifications of our components may not be considered as an assurance of component characteristics. Components have to be tested for the respective application. Adjustments may be necessary. The use of SEMIKRON products in life support appliances and systems is subject to prior specification and written approval by SEMIKRON. We therefore strongly recommend prior consultation of our personal.