

# SKKD 115F

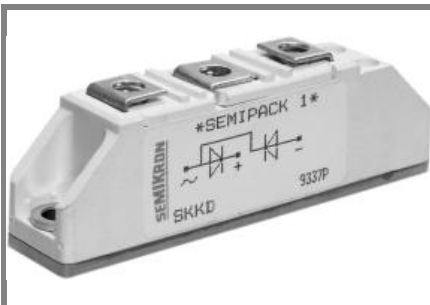

## SEMIPACK<sup>®</sup> 1

### Fast Diode Modules

#### SKKD 115F

#### Features

- Heat transfer through ceramic isolated metal baseplate
- Hard soldered joints for high reliability
- UL recognized, file no. E 63 532

#### Typical Applications\*

- Self-commutated inverters
- DC choppers
- AC motor speed control
- Inductive heating
- Uninterruptible power supplies
- Electronic welders
- General power switching applications

$V_{RSM}$ V	$V_{RRM}$ V	$I_{FRMS} = 200$ A (maximum value for continuous operation) $I_{FAV} = 115$ A (sin. 180; $T_c = 83$ °C)	
1200	1200	SKKD 115F12	
1400	1400	SKKD 115F14	

Symbol	Conditions	Values	Units
$I_{FAV}$	sin. 180; $T_c = 85$ (100) °C	113 (83)	A
$I_{FSM}$	$T_{vj} = 25$ °C; 10 ms	2500	A
	$T_{vj} = 130$ °C; 10 ms	2100	A
$i^2t$	$T_{vj} = 25$ °C; 8,3 ... 10 ms	31250	A <sup>2</sup> s
	$T_{vj} = 130$ °C; 8,3 ... 10 ms	22000	A <sup>2</sup> s
$V_F$	$T_{vj} = 25$ °C; $I_F = 300$ A	max. 1,8	V
$V_{(TO)}$	$T_{vj} = 130$ °C	max. 1,1	V
$r_T$	$T_{vj} = 130$ °C	max. 2	mΩ
$I_{RD}$	$T_{vj} = 25$ °C; $V_{RD} = V_{RRM}$	max. 1	mA
$I_{RD}$	$T_{vj} = 130$ °C; $V_{RD} = V_{RRM}$	max. 30	mA
$Q_{rr}$	$T_{vj} = 130$ °C, $I_F = 100$ A,	90	μC
$I_{RM}$	$-di/dt = 50$ A/μs, $V_R = 30$ V	90	A
$t_{rr}$		2000	ns
$E_{rr}$		1,35	mJ
$R_{th(j-c)}$	per diode / per module	0,24 / 0,12	K/W
$R_{th(c-s)}$	per diode / per module	0,2 / 0,1	K/W
$T_{vj}$		- 40 ... + 130	°C
$T_{stg}$		- 40 ... + 125	°C
$V_{isol}$	a. c. 50 Hz; r.m.s.; 1 s / 1 min.	3600 / 3000	V~
$M_s$	to heatsink	5 ± 15 %	Nm
$M_t$	to terminals	3 ± 15 %	Nm
$a$		5 * 9,81	m/s <sup>2</sup>
$m$	approx.	120	g
Case		A 10	

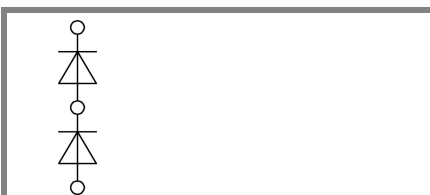

SKKD

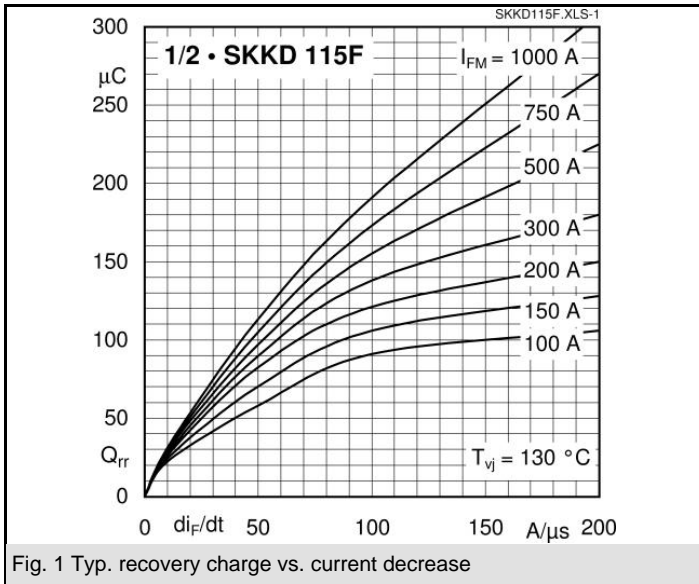

Fig. 1 Typ. recovery charge vs. current decrease

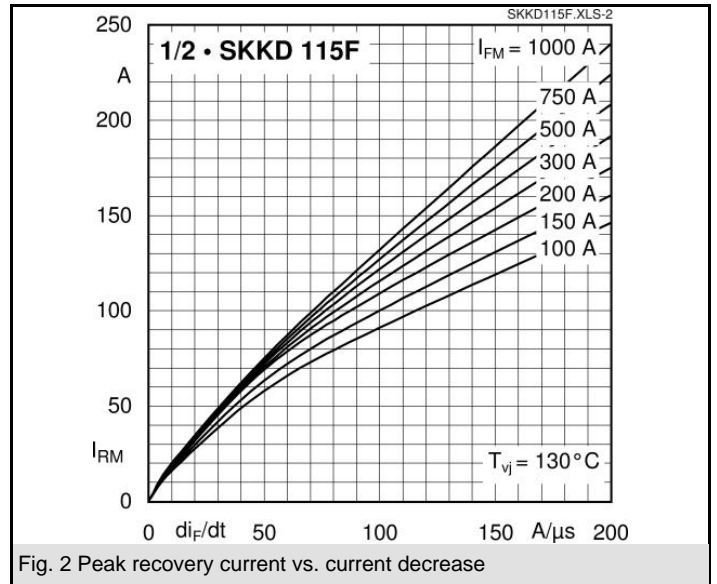

Fig. 2 Peak recovery current vs. current decrease

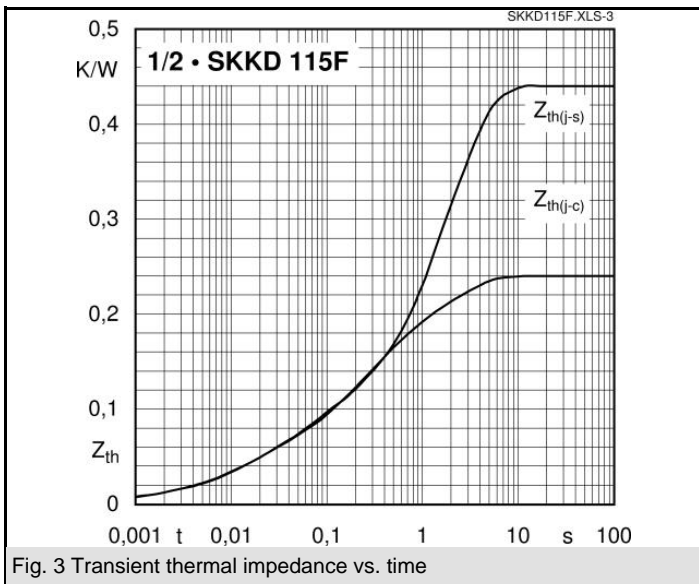

Fig. 3 Transient thermal impedance vs. time

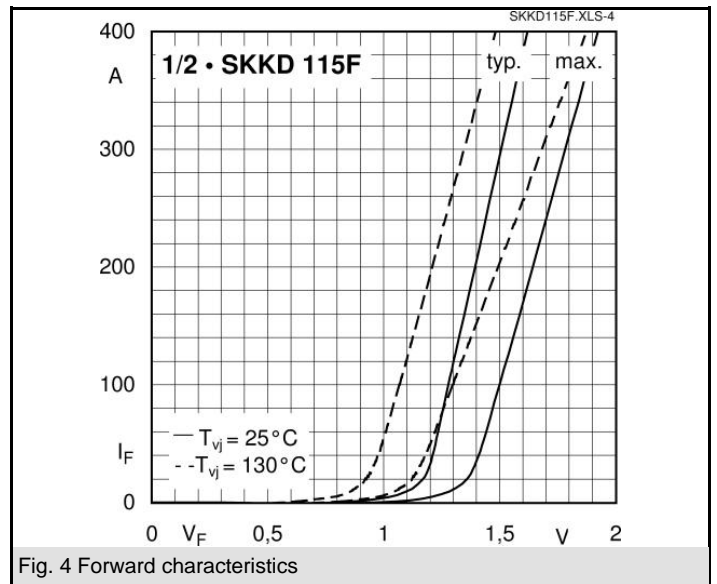

Fig. 4 Forward characteristics

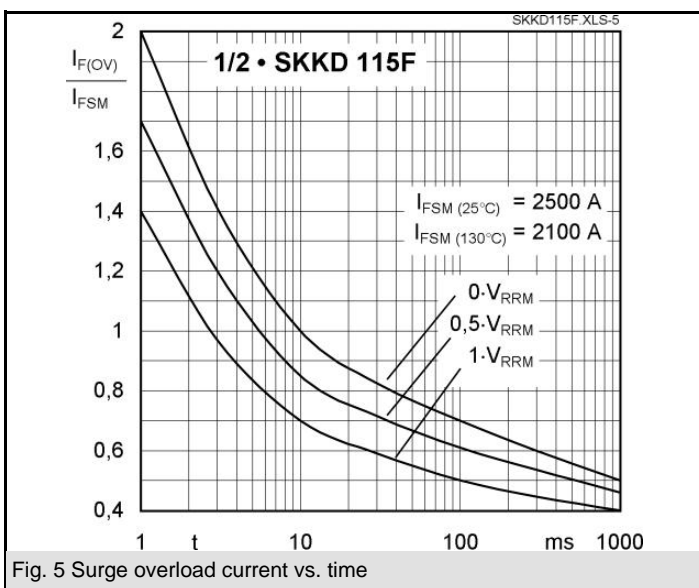
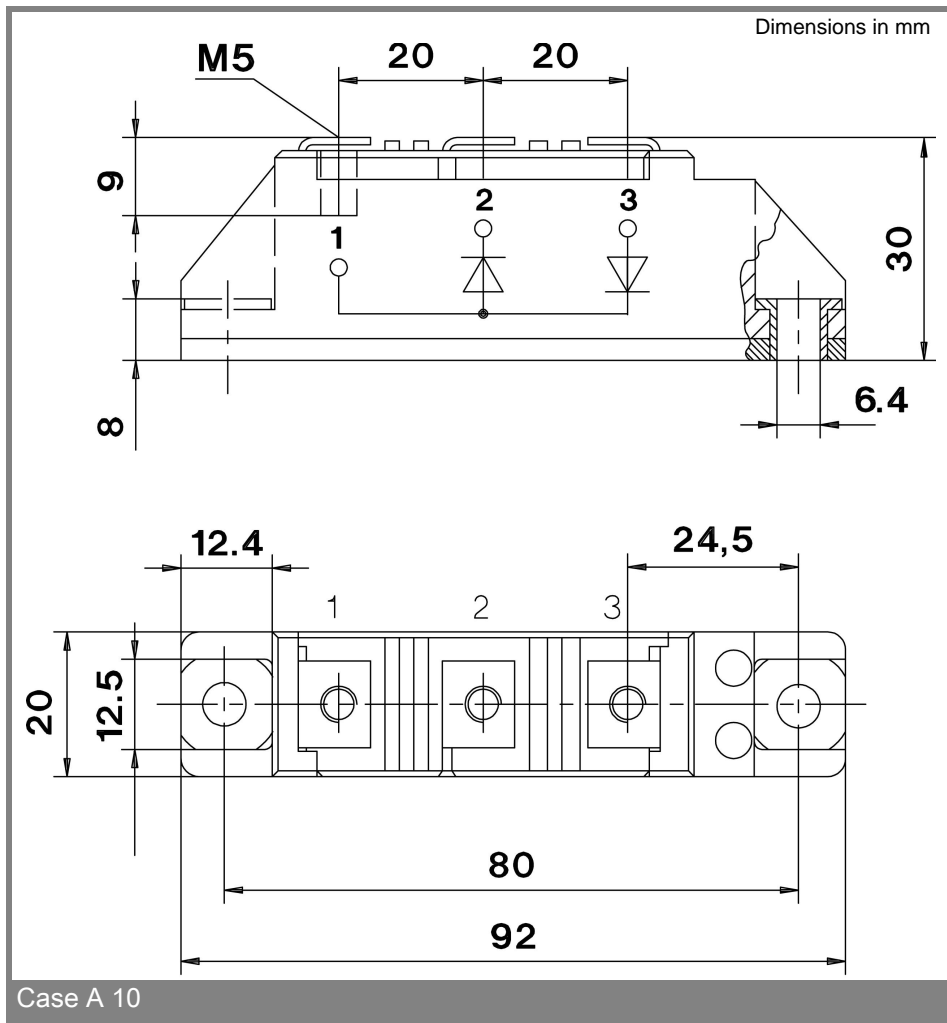

Fig. 5 Surge overload current vs. time



\* The specifications of our components may not be considered as an assurance of component characteristics. Components have to be tested for the respective application. Adjustments may be necessary. The use of SEMIKRON products in life support appliances and systems is subject to prior specification and written approval by SEMIKRON. We therefore strongly recommend prior consultation of our personal.