

SKiiP 03NAC066V3



MiniSKiiP[®] 0

3-phase bridge rectifier +
3-phase bridge inverter

SKiiP 03NAC066V3

Target Data

Features

- Trench IGBTs
- Robust and soft freewheeling diodes in CAL technology
- Highly reliable spring contacts for electrical connections
- UL recognised file no. E63532

Typical Applications*

- Inverter up to 5,6 kVA
- Typical motor power 3,0 kW

Remarks

- Case temperature limited to $T_C = 125^\circ\text{C}$ max.
- Product reliability results are valid for $T_j = 150^\circ\text{C}$
- SC data: $t_p \leq 6 \mu\text{s}$; $V_{GE} \leq 15 \text{ V}$; $T_j = 150^\circ\text{C}$; $V_{CC} = 360 \text{ V}$
- V_{CEsat} , V_F = chip level value

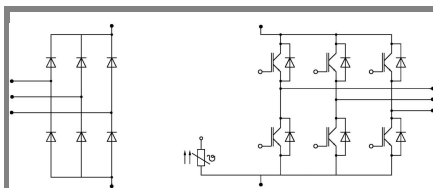

NAC

Absolute Maximum Ratings		$T_s = 25^\circ\text{C}$, unless otherwise specified	
Symbol	Conditions	Values	Units
IGBT - Inverter			
V_{CES}		600	V
I_C	$T_s = 25 (70)^\circ\text{C}$, $T_j = 150^\circ\text{C}$	24 (17)	A
I_C	$T_s = 25 (70)^\circ\text{C}$, $T_j = 175^\circ\text{C}$	27 (20)	A
I_{CRM}	$t_p = 1 \text{ ms}$	30	A
V_{GES}		± 20	V
Diode - Inverter			
I_F	$T_s = 25 (70)^\circ\text{C}$, $T_j = 150^\circ\text{C}$	24 (16)	A
I_F	$T_s = 25 (70)^\circ\text{C}$, $T_j = 175^\circ\text{C}$	28 (21)	A
I_{FRM}	$t_p = 1 \text{ ms}$	30	A
Diode - Rectifier			
V_{RRM}		800	V
I_F	$T_s = 70^\circ\text{C}$	35	A
I_{FSM}	$t_p = 10 \text{ ms}$, $\sin 180^\circ$, $T_j = 25^\circ\text{C}$	220	A
i^2t	$t_p = 10 \text{ ms}$, $\sin 180^\circ$, $T_j = 25^\circ\text{C}$	240	A ² s
I_{tRMS}	per power terminal (20 A / spring)	20	A
T_j	IGBT, Diode	-40...+175	$^\circ\text{C}$
T_{stg}		-40...+125	$^\circ\text{C}$
V_{isol}	AC, 1 min.	2500	V

Characteristics		$T_s = 25^\circ\text{C}$, unless otherwise specified			Units
Symbol	Conditions	min.	typ.	max.	Units
IGBT - Inverter					
$V_{CE(sat)}$	$I_{Cnom} = 15 \text{ A}$, $T_j = 25 (150)^\circ\text{C}$	1,1	1,45 (1,65)	1,85 (2,05)	V
$V_{GE(th)}$	$V_{GE} = V_{CE}$, $I_C = 1 \text{ mA}$		5,8		V
$V_{CE(TO)}$	$T_j = 25 (150)^\circ\text{C}$		0,9 (0,85)	1 (0,9)	V
r_{CE}	$T_j = 25 (150)^\circ\text{C}$		40 (57)	60 (80)	m Ω
C_{ies}	$V_{CE} = 25 \text{ V}$, $V_{GE} = 0 \text{ V}$, $f = 1 \text{ MHz}$		0,86		nF
C_{oes}	$V_{CE} = 25 \text{ V}$, $V_{GE} = 0 \text{ V}$, $f = 1 \text{ MHz}$		0,18		nF
C_{res}	$V_{CE} = 25 \text{ V}$, $V_{GE} = 0 \text{ V}$, $f = 1 \text{ MHz}$		0,12		nF
$R_{CC+EE'}$	spring contact-chip $T_s = ()^\circ\text{C}$				m Ω
$R_{th(j-s)}$	per IGBT		1,8		K/W
$t_{d(on)}$	under following conditions		20		ns
t_r	$V_{CC} = 300 \text{ V}$, $V_{GE} = \pm 15 \text{ V}$		30		ns
$t_{d(off)}$	$I_{Cnom} = 15 \text{ A}$, $T_j = 150^\circ\text{C}$		155		ns
t_f	$R_{Gon} = R_{Goff} = 22 \Omega$		45		ns
$E_{on} (E_{off})$	inductive load		0,6 (0,5)		mJ
Diode - Inverter					
$V_F = V_{EC}$	$I_F = 15 \text{ A}$, $T_j = 25 (150)^\circ\text{C}$		1,4 (1,4)	1,7 (1,7)	V
$V_{(TO)}$	$T_j = 25 (150)^\circ\text{C}$		1 (0,9)	1,1 (1)	V
r_T	$T_j = 25 (150)^\circ\text{C}$		27 (34)	40 (47)	m Ω
$R_{th(j-s)}$	per diode		2,5		K/W
I_{RRM}	under following conditions		20		A
Q_{rr}	$I_{Fnom} = 15 \text{ A}$, $V_R = 300 \text{ V}$		1,8		μC
E_{rr}	$V_{GE} = 0 \text{ V}$, $T_j = 150^\circ\text{C}$		0,5		mJ
	$di_F/dt = 930 \text{ A}/\mu\text{s}$				
Diode - Rectifier					
V_F	$I_{Fnom} = 15 \text{ A}$, $T_j = 25^\circ\text{C}$		1,1		V
$V_{(TO)}$	$T_j = 150^\circ\text{C}$		0,8		V
r_T	$T_j = 150^\circ\text{C}$		20		m Ω
$R_{th(j-s)}$	per diode		1,5		K/W
Temperature Sensor					
R_{ts}	3 %, $T_r = 25 (100)^\circ\text{C}$		1000(1670)		Ω
Mechanical Data					
w			21,5		g
M_s	Mounting torque	2		2,5	Nm

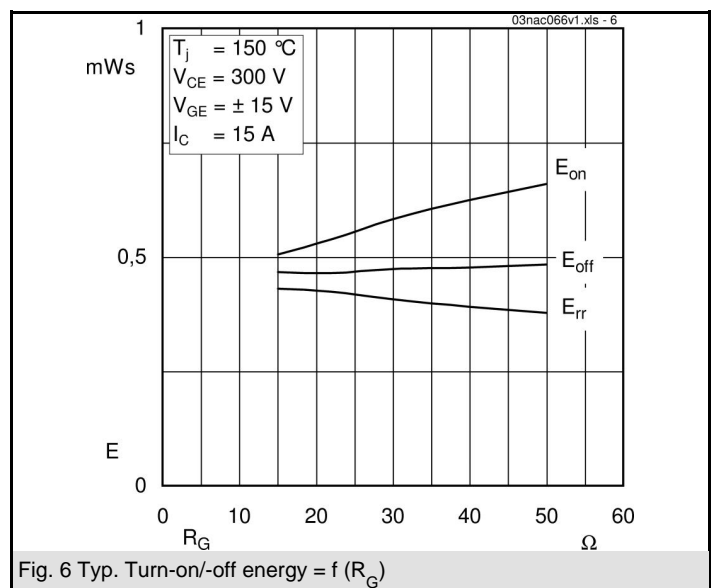
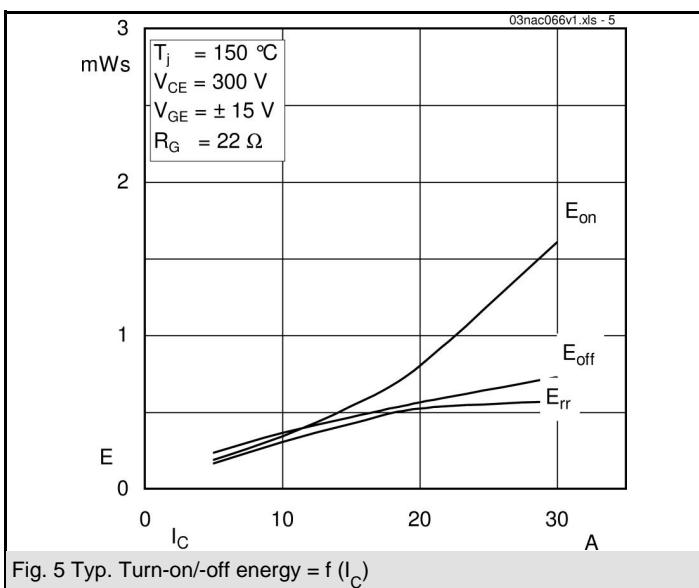
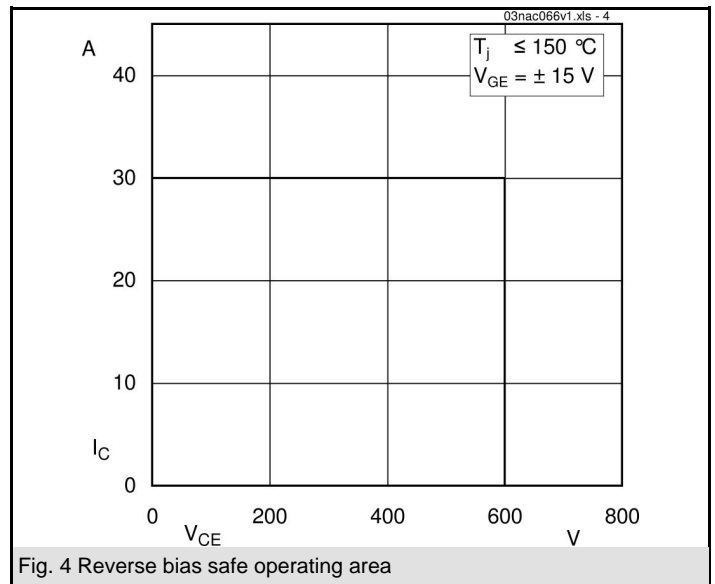
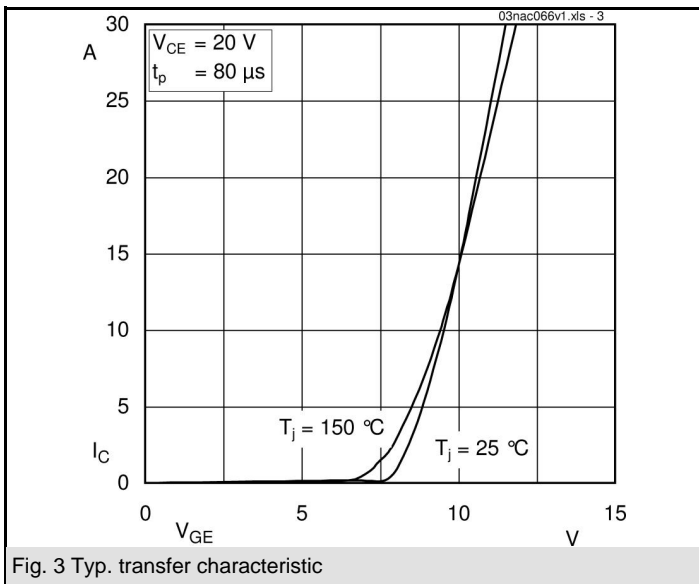
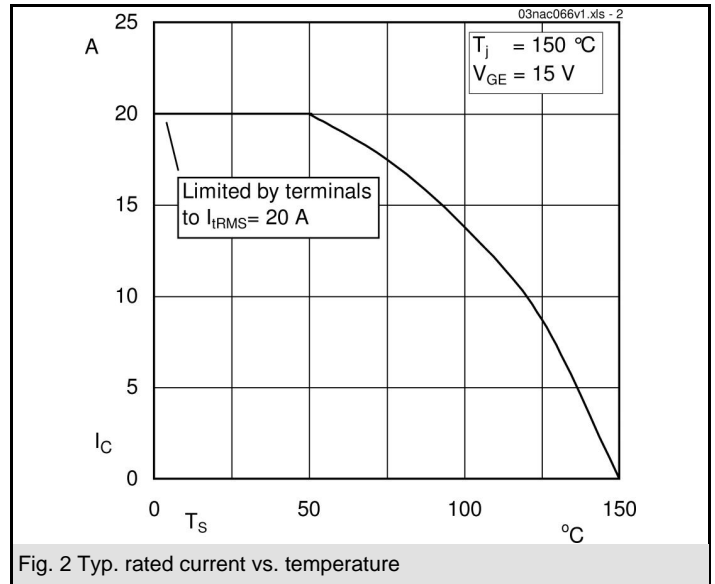
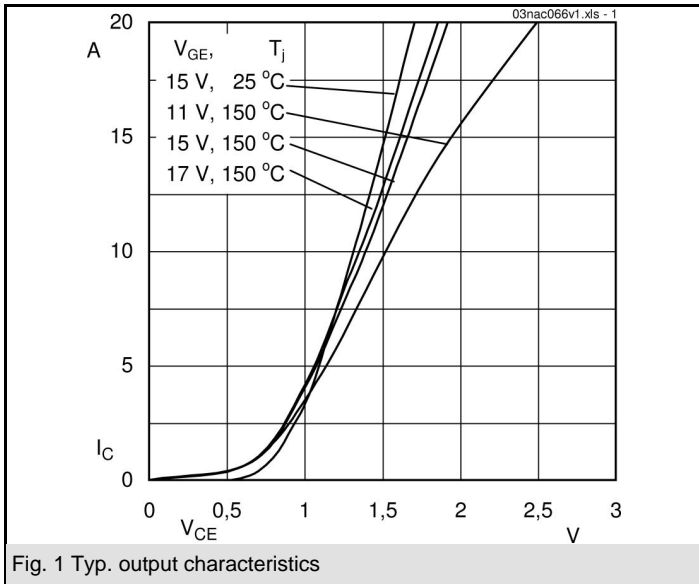

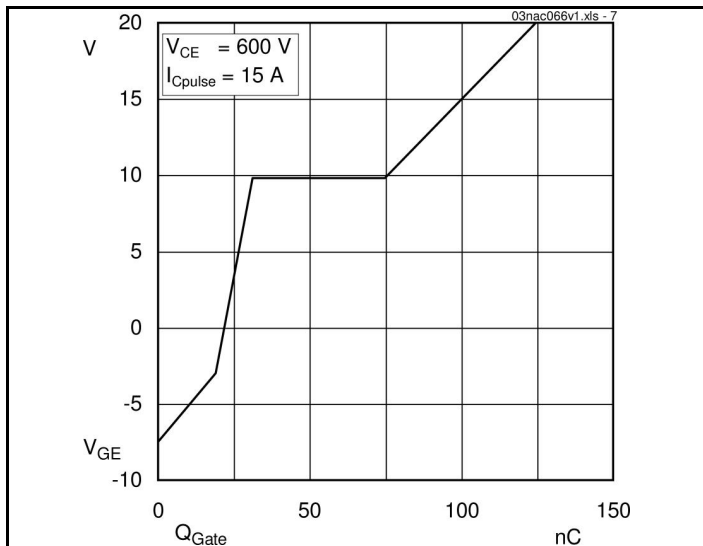

Fig. 7 Typ. gate charge characteristic

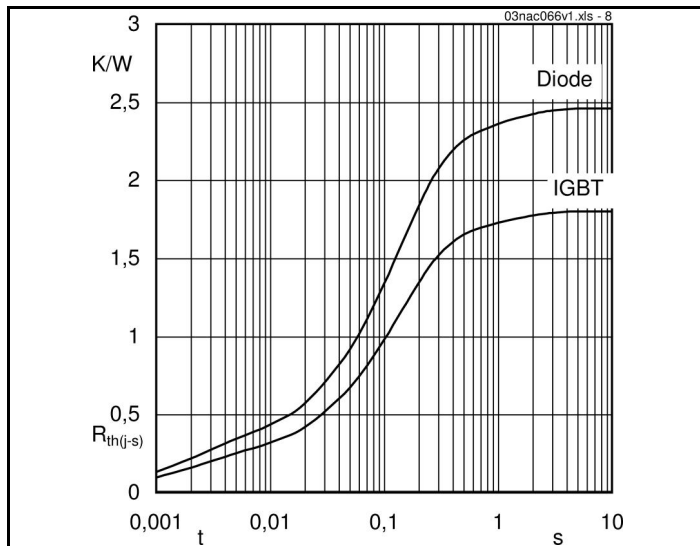

Fig. 8 Typ. thermal impedance

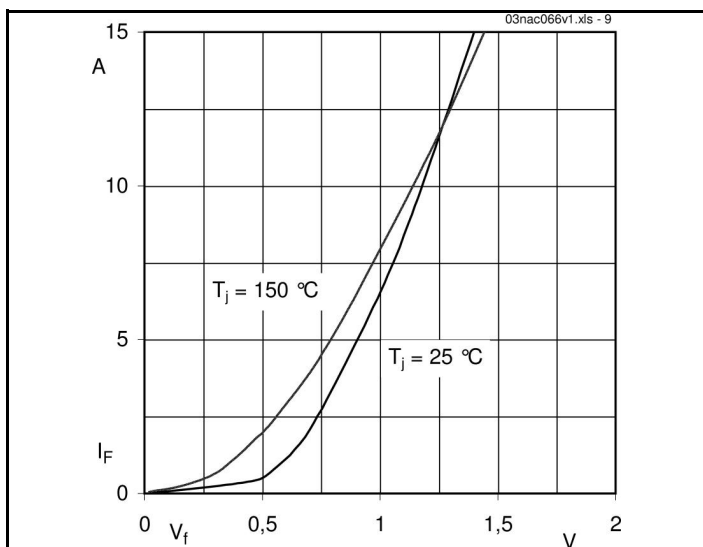

Fig. 9 Typ. freewheeling diode forward characteristic

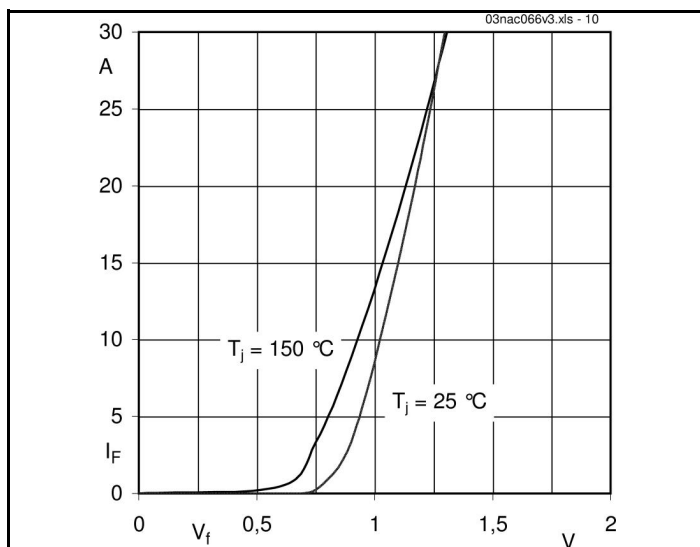
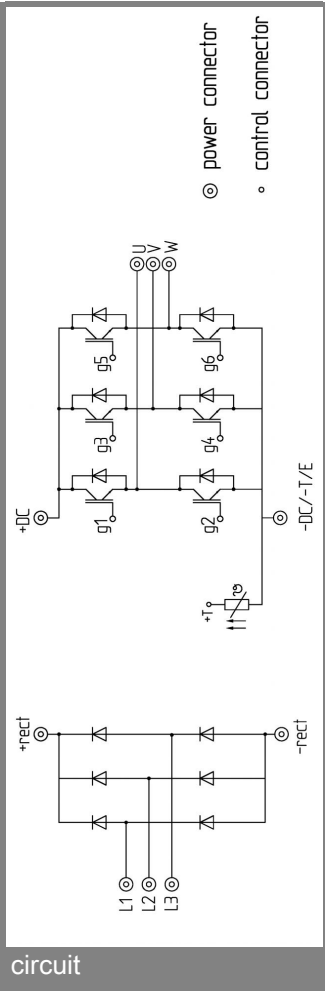

Fig. 10 Typ. input bridge forward characteristic



circuit

