

SEMITOP® 2

IGBT Module

SK70GAL063

SK70GAR063

Preliminary Data

Features

- Compact design
- One screw mounting
- Heat transfer and isolation through direct copper bonded aluminium oxide ceramic (DCB)
- High short circuit capability
- Low tail current with low temperature dependence

Typical Applications*

- Switching (not for linear use)
- Inverter
- Switched mode power supplies
- UPS

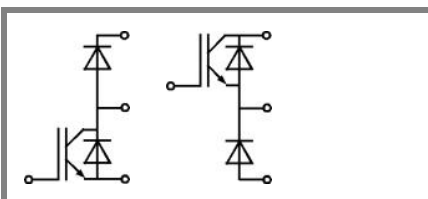

GAL

GAR

Absolute Maximum Ratings		$T_s = 25\text{ °C}$, unless otherwise specified		
Symbol	Conditions	Values		Units
IGBT				
V_{CES}	$T_j = 25\text{ °C}$	600		V
I_C	$T_j = 125\text{ °C}$	$T_s = 25\text{ °C}$	81	A
		$T_s = 80\text{ °C}$	57	A
I_{CRM}	$I_{CRM} = 2 \times I_{Cnom}$	200		A
V_{GES}		± 20		V
t_{psc}	$V_{CC} = 300\text{ V}; V_{GE} \leq 20\text{ V}; T_j = 125\text{ °C}$ $V_{CES} < 600\text{ V}$	10		µs
Inverse Diode				
I_F	$T_j = 150\text{ °C}$	$T_s = 25\text{ °C}$	22	A
		$T_s = 80\text{ °C}$	15	A
I_{FRM}	$I_{FRM} = 2 \times I_{Fnom}$	28		A
I_{FSM}	$t_p = 10\text{ ms}; \text{half sine wave } T_j = 150\text{ °C}$	100		A
Freewheeling Diode				
I_F	$T_j = 150\text{ °C}$	$T_s = 25\text{ °C}$	79	A
		$T_s = 80\text{ °C}$	53	A
I_{FRM}		150		A
I_{FSM}	$t_p = 10\text{ ms}; \text{half sine wave } T_j = 150\text{ °C}$	720		A
Module				
$I_{t(RMS)}$				A
T_{vj}		-40 ... +150		°C
T_{stg}		-40 ... +125		°C
V_{isol}	AC, 1 min.	2500		V

Characteristics		$T_s = 25\text{ °C}$, unless otherwise specified			
Symbol	Conditions	min.	typ.	max.	Units
IGBT					
$V_{GE(th)}$	$V_{GE} = V_{CE}, I_C = 1,5\text{ mA}$	4,5	5,5	6,5	V
I_{CES}	$V_{GE} = 0\text{ V}, V_{CE} = V_{CES}$	$T_j = 25\text{ °C}$	0,3		mA
		$T_j = 125\text{ °C}$			mA
I_{GES}	$V_{CE} = 0\text{ V}, V_{GE} = 30\text{ V}$	$T_j = 25\text{ °C}$	300		nA
		$T_j = 125\text{ °C}$			nA
V_{CE0}		$T_j = 25\text{ °C}$	1		V
		$T_j = 125\text{ °C}$	1,1		V
r_{CE}	$V_{GE} = 15\text{ V}$	$T_j = 25\text{ °C}$	11		mΩ
		$T_j = 125\text{ °C}$	9		mΩ
$V_{CE(sat)}$	$I_{Cnom} = 100\text{ A}, V_{GE} = 15\text{ V}$	$T_j = 25\text{ °C}_{chiplev.}$	2,1	2,5	V
		$T_j = 125\text{ °C}_{chiplev.}$	2	2,3	V
C_{ies}	$V_{CE} = 25, V_{GE} = 0\text{ V}$	4,3		nF	
C_{oes}				nF	
C_{res}		0,4		nF	
Q_G	$V_{GE} = 0 \dots 20\text{ V}$	310		nC	
$t_{d(on)}$	$R_{Gon} = 10\text{ Ω}$	$V_{CC} = 300\text{ V}$ $I_C = 100\text{ A}$	50		ns
t_r			40		ns
E_{on}			4		mJ
$t_{d(off)}$	$R_{Goff} = 10\text{ Ω}$	$T_j = 125\text{ °C}$ $V_{GE} = \pm 15\text{ V}$	300		ns
t_f			35		ns
E_{off}			3		mJ
$R_{th(j-s)}$	per IGBT	0,6		K/W	

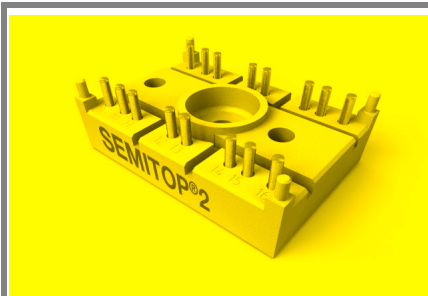

SEMITOP[®] 2

IGBT Module

SK70GAL063

SK70GAR063

Preliminary Data

Features

- Compact design
- One screw mounting
- Heat transfer and isolation through direct copper bonded aluminium oxide ceramic (DCB)
- High short circuit capability
- Low tail current with low temperature dependence

Typical Applications*

- Switching (not for linear use)
- Inverter
- Switched mode power supplies
- UPS

Characteristics			min.	typ.	max.	Units
Inverse Diode						
$V_F = V_{EC}$	$I_{Fnom} = 10 \text{ A}; V_{GE} = 0 \text{ V}$	$T_j = 25 \text{ }^\circ\text{C}_{\text{chiplev.}}$		1,45	1,7	V
		$T_j = 125 \text{ }^\circ\text{C}_{\text{chiplev.}}$		1,4	1,7	V
V_{F0}		$T_j = 125 \text{ }^\circ\text{C}$		0,85	0,9	V
r_F		$T_j = 125 \text{ }^\circ\text{C}$		55	80	mΩ
I_{RRM}	$I_F = 10 \text{ A}$	$T_j = 125 \text{ }^\circ\text{C}$		6,5		A
Q_{rr}	$di/dt = -200 \text{ A}/\mu\text{s}$			1		μC
E_{rr}	$V_{CC} = 300\text{V}$			0,1		mJ
$R_{th(j-s)D}$	per diode				2,3	K/W
Freewheeling Diode						
$V_F = V_{EC}$	$I_{Fnom} = 60 \text{ A}; V_{GE} = 0 \text{ V}$	$T_j = 25 \text{ }^\circ\text{C}_{\text{chiplev.}}$		1,4		V
		$T_j = 125 \text{ }^\circ\text{C}_{\text{chiplev.}}$		1,3		V
V_{F0}		$T_j = 125 \text{ }^\circ\text{C}$		0,85	0,9	V
r_F		$T_j = 125 \text{ }^\circ\text{C}$		6,5	11	V
I_{RRM}	$I_F = 60 \text{ A}$	$T_j = 125 \text{ }^\circ\text{C}$		90		A
Q_{rr}	$di/dt = -3000 \text{ A}/\mu\text{s}$			7		μC
E_{rr}	$V_R = 300\text{V}$			1,2		mJ
$R_{th(j-s)FD}$	per diode				0,9	K/W
M_s	to heat sink M1				2	Nm
w					19	g

This is an electrostatic discharge sensitive device (ESDS), international standard IEC 60747-1, Chapter IX.

* The specifications of our components may not be considered as an assurance of component characteristics. Components have to be tested for the respective application. Adjustments may be necessary. The use of SEMIKRON products in life support appliances and systems is subject to prior specification and written approval by SEMIKRON. We therefore strongly recommend prior consultation of our personal.

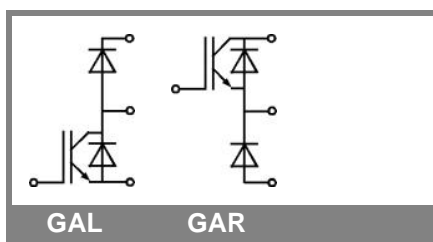

GAL

GAR

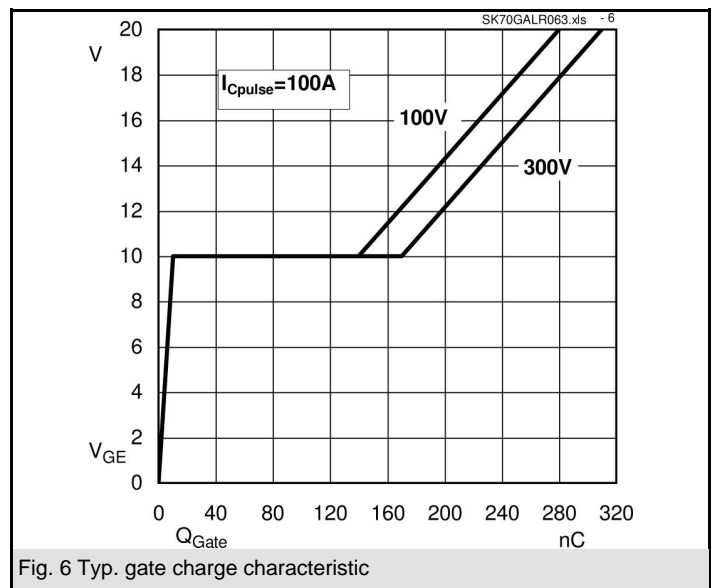
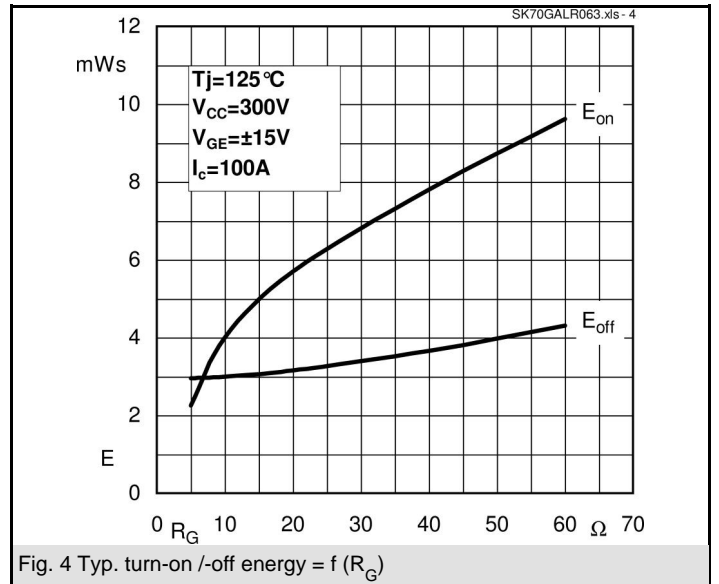
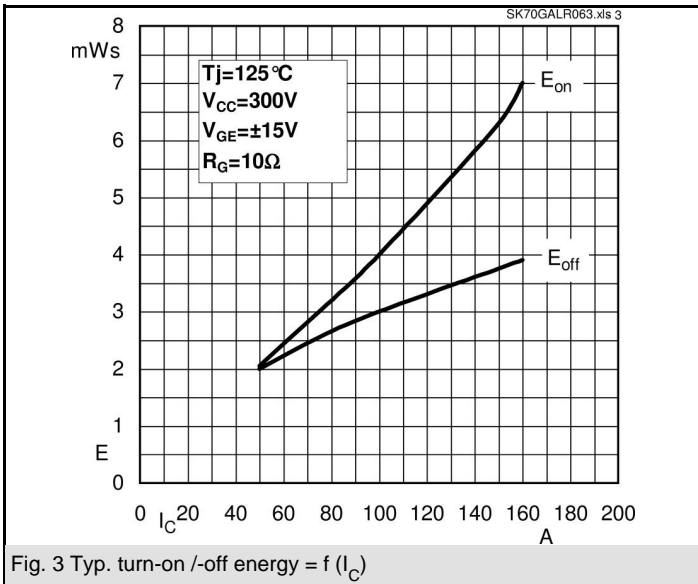
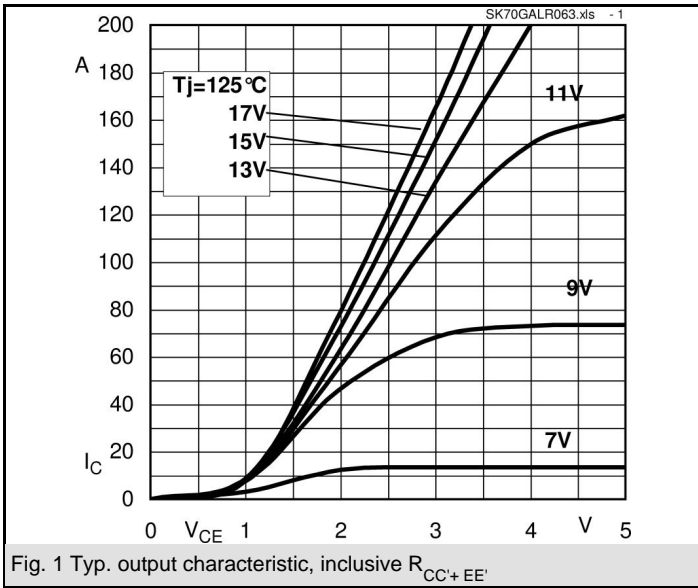

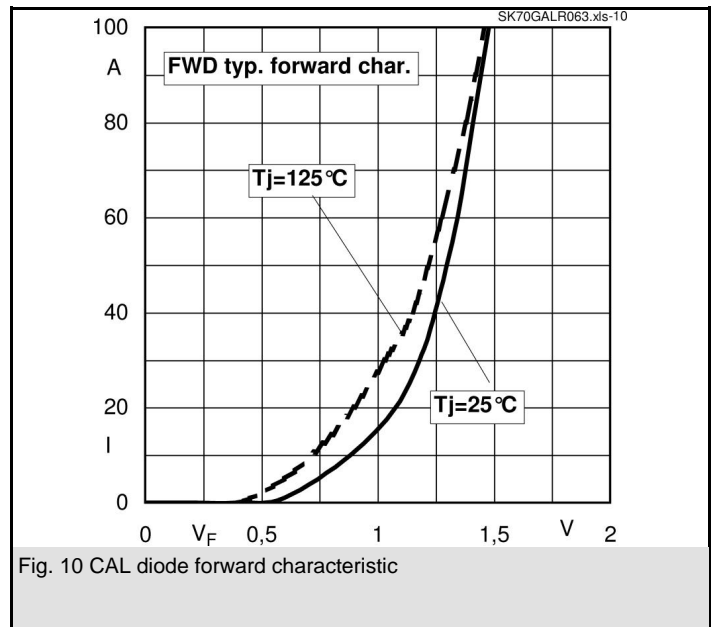
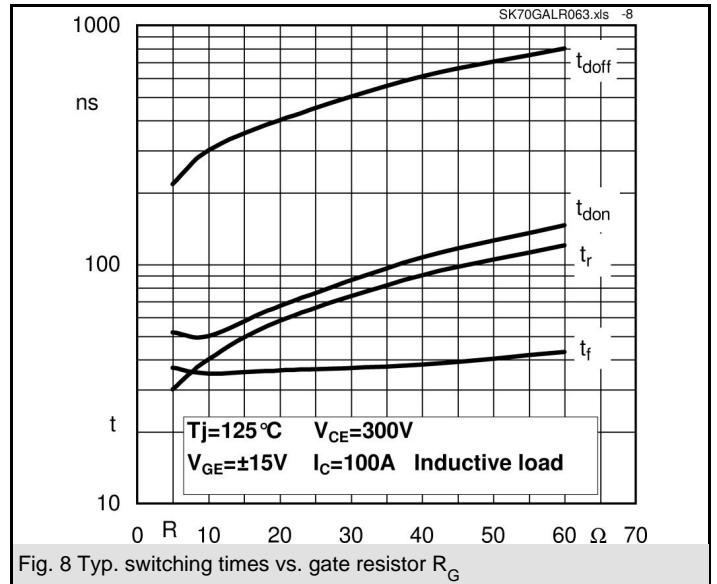
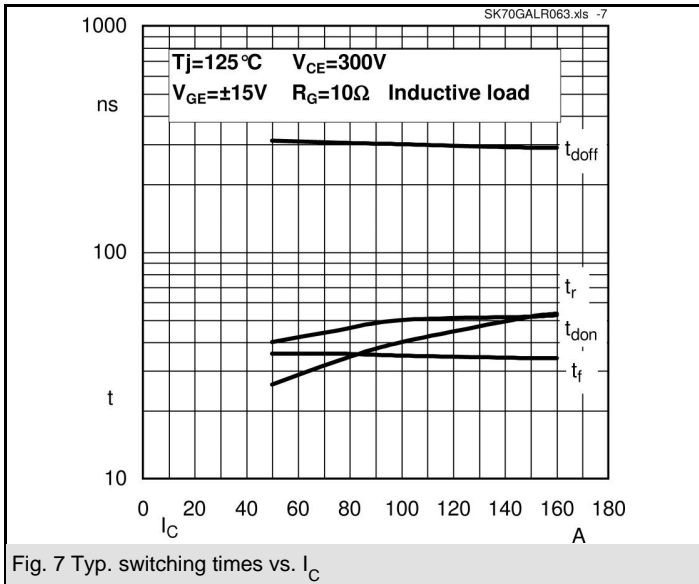

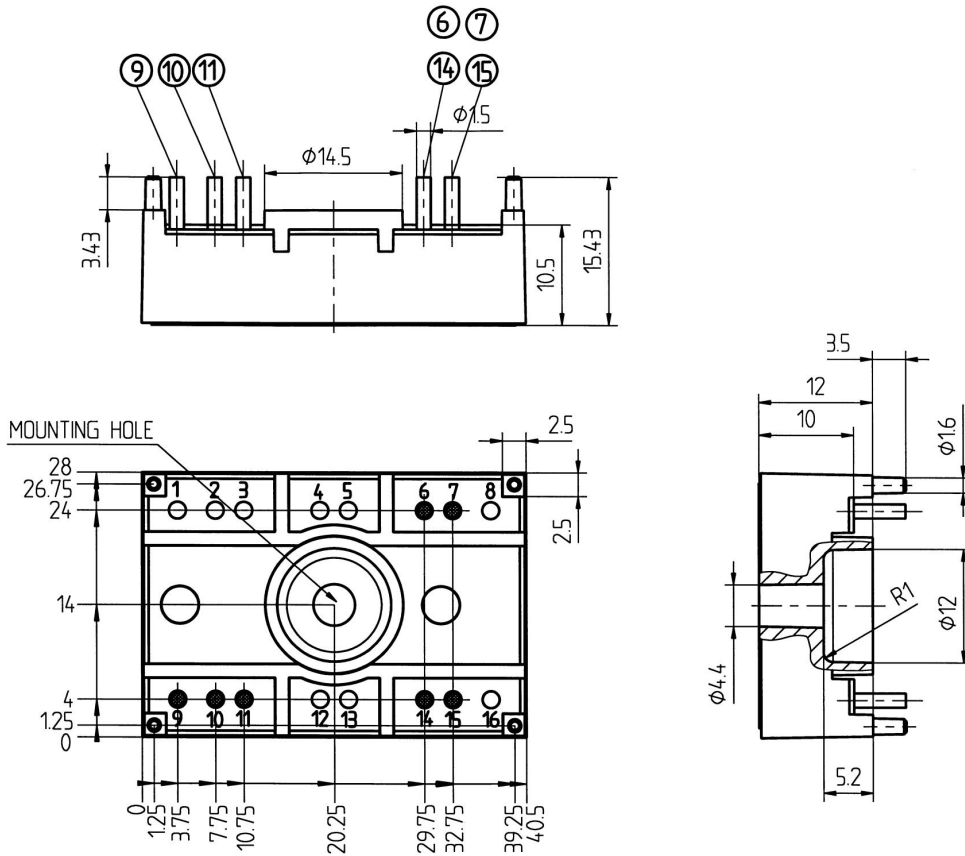

Case T18 (Suggested hole diameter, in the PCB, for solder pins and plastic mounting pins: 2mm)

