

SK 70 B

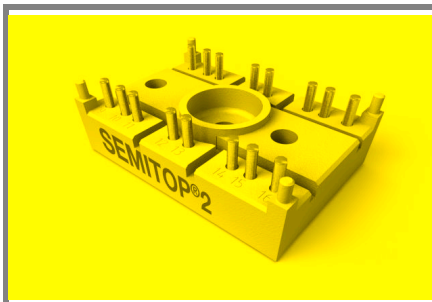

SEMITOP[®] 2

Bridge Rectifier

SK 70 B

Preliminary Data

Features

- Compact design
- One screw mounting
- Heat transfer and insulation through direct copper bonded aluminium oxide ceramic (DCB)
- Up 1600V reverse voltage
- High surge current
- Glass passivated diode chips
- UL recognized, file no. E 63 532

Typical Applications*

- Input rectifier for power supplies
- Rectifier

V_{RSM} V	V_{RRM}, V_{DRM} V	$I_D = 68$ A (full conduction) ($T_s = 80$ °C)
800	800	SK 70 B 08
1200	1200	SK 70 B 12
1600	1600	SK 70 B 16

Symbol	Conditions	Values	Units
I_D	$T_s = 80$ °C	68	A
I_{FSM}	$T_{vj} = 25$ °C; 10 ms $T_{vj} = 125$ °C; 10 ms	700 560	A A
i^2t	$T_{vj} = 25$ °C; 8,3...10 ms $T_{vj} = 125$ °C; 8,3...10 ms	2450 1370	A ² s A ² s
V_F	$T_{vj} = 25$ °C; $I_F = 35$ A	max. 1,2	V
$V_{(TO)}$	$T_{vj} = 125$ °C	max. 0,8	V
r_T	$T_{vj} = 125$ °C	max. 11	mΩ
I_{RD}	$T_{vj} = 150$ °C; $V_{DD} = V_{DRM}$; $V_{RD} = V_{RRM}$	max. 4	mA mA
$R_{th(f-s)}$	per diode per module	1,2 0,3	K/W K/W
T_{solder}	terminals, 10s	260	°C
T_{vj}		-40...+150	°C
T_{stg}		-40...+125	°C
V_{isol}	a. c. 50 Hz; r.m.s.; 1 s / 1 min.	3000 (2500)	V
M_s	mounting torque to heatsink	2	Nm
M_t			
m	approx. weight	19	g
Case	SEMITOP [®] 2	T 6	

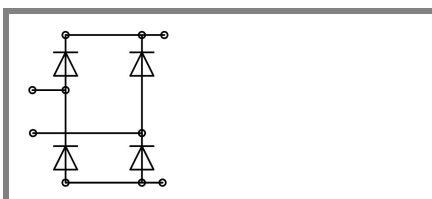

B

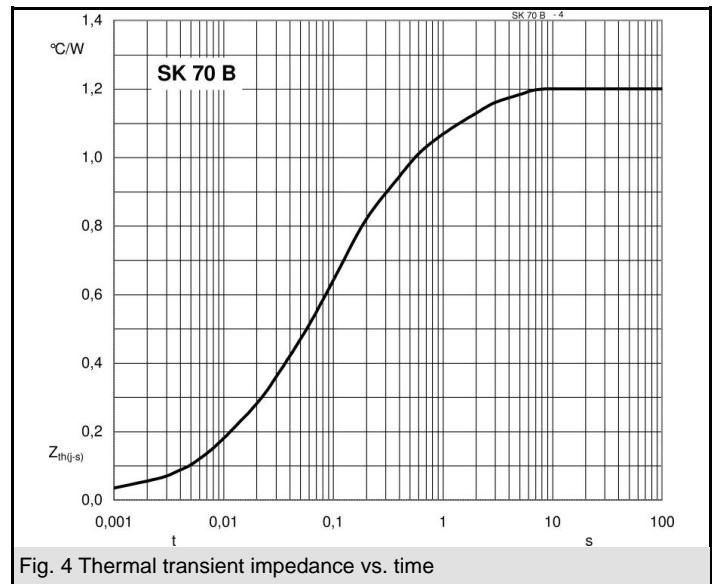
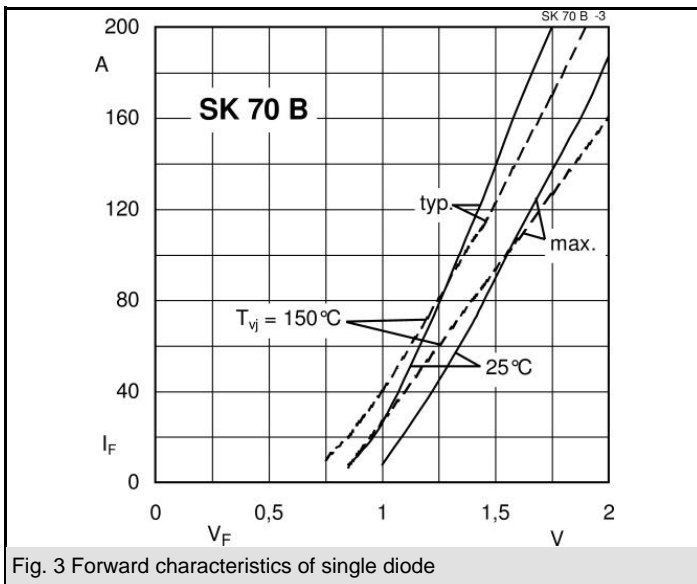
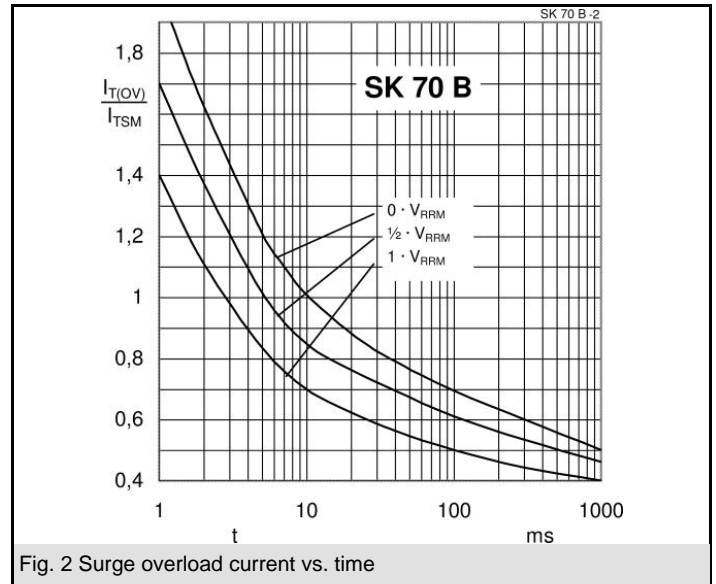
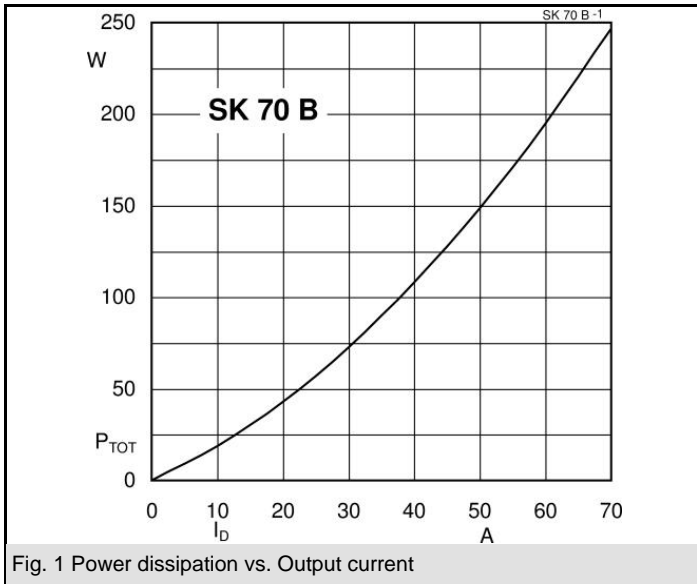

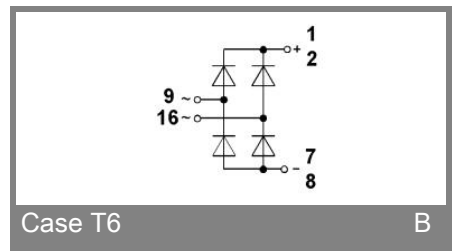
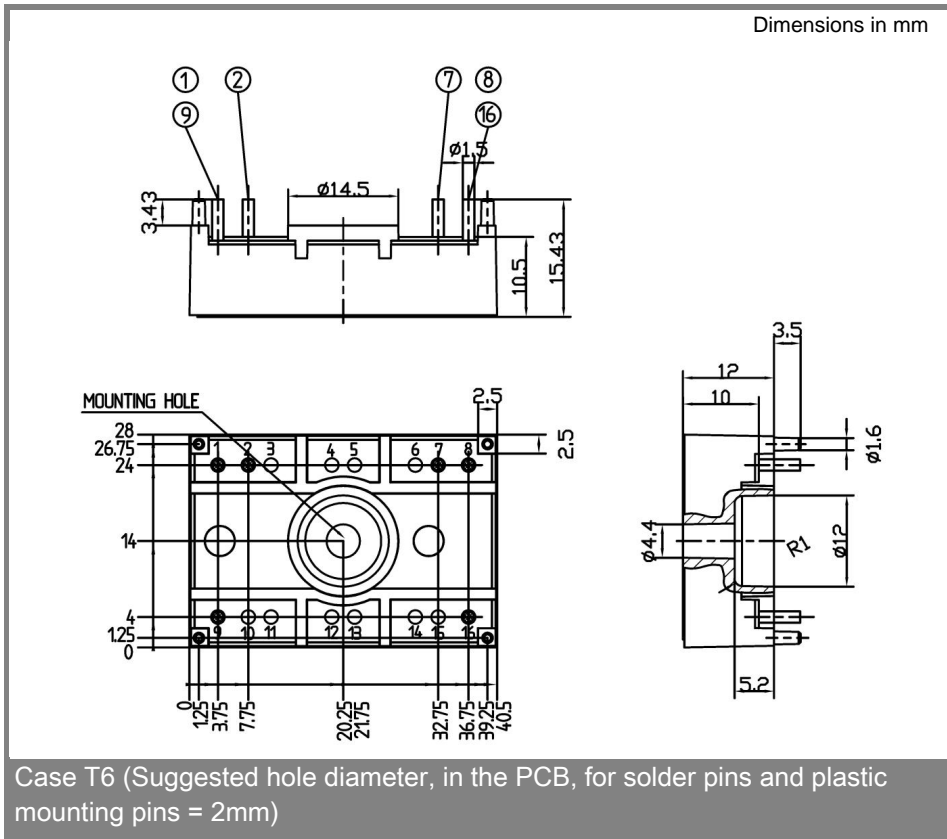

* The specifications of our components may not be considered as an assurance of component characteristics. Components have to be tested for the respective application. Adjustments may be necessary. The use of SEMIKRON products in life support appliances and systems is subject to prior specification and written approval by SEMIKRON. We therefore strongly recommend prior consultation of our personal.