

SK 45 STA

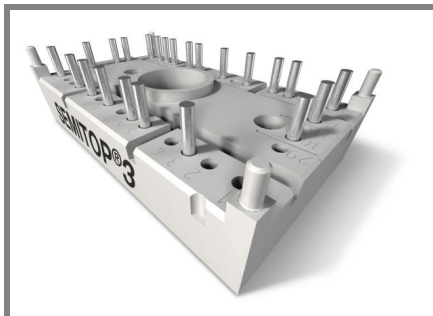

SEMITOP® 3

Six Separated Thyristors Module

SK 45 STA

Preliminary Data

Features

- Compact design
- One screw mounting
- Heat transfer and isolation through direct copper bonded aluminium oxide ceramic (DCB)
- Glass passivated thyristor chips
- Up to 1600 V reverse voltage

Typical Applications*

- Soft starters
- Light control (studios, theatres...)
- Temperature control

V_{RSM} V	V_{RRM}, V_{DRM} V	$I_{TRMS} = 41$ A ($T_s = 75$ °C)
900	800	SK 45 STA 08
1300	1200	SK 45 STA 12
1700	1600	SK 45 STA 16

Characteristics		$T_h = 25$ °C, unless otherwise specified	
Symbol	Conditions	Values	Units
I_{rms} (W1C)	sin. 180°; $T_s = 100$ °C	33	A
I_{rms} (W1C)	sin. 180°; $T_s = 85$ °C	47	A
			A
I_{TSM}/I_{FSM}	$T_{vj} = 25$ (125) °C; 10 ms	450 (380)	A
I^2t	$T_{vj} = 25$ (125) °C; 8,3 ... 10 ms ms	1000 (720)	A²s
T_{stg}		- 40 ... + 125	°C
T_{solder}	terminals, 10 s	260	°C
Thyristor			
$(dv/dt)_{cr}$	$T_{vj} = 125$ °C	1000	V/μs
$(di/dt)_{cr}$	$T_{vj} = 125$ °C; $f = 50 \dots 60$ Hz	50	A/μs
t_q	$T_{vj} = 125$ °C; typ.	80	μs
I_H	$T_{vj} = 25$ °C; typ. / max.	80 / 150	mA
I_L	$T_{vj} = 25$ °C; $R_G = 33$ Ω; typ. / max.	150 / 300	mA
V_T	$T_{vj} = 25$ °C; ($I_T = 75$ A); max.	1,9	V
$V_{T(TO)}$	$T_{vj} = 125$ °C	max. 1	V
r_T	$T_{vj} = 125$ °C	max. 10	mΩ
I_{DD}, I_{RD}	$T_{vj} = 125$ °C; $V_{DD} = V_{DRM}, V_{RD} = V_{RRM}$	max. 10	mA
$R_{th(j-s)}$		1,2	K/W
T_{vj}		- 40 ... + 125	°C
V_{GT}	$T_{vj} = 25$ °C; d.c.	3	V
I_{GT}	$T_{vj} = 25$ °C; d.c.	100	mA
V_{GD}	$T_{vj} = 125$ °C; d.c.	0,25	V
I_{GD}	$T_{vj} = 125$ °C; d.c.	3	mA
Diode			
V_F	$T_{vj} =$ °C; ($I_F =$ A); max.		V
$V_{(TO)}$	$T_{vj} =$ °C		V
r_T	$T_{vj} =$ °C		mΩ
I_{RD}	$T_{vj} =$ °C; $V_{RD} = V_{RRM}$		mA
$R_{th(j-s)}$			K/W
T_{vj}			°C
Mechanical data			
V_{isol}	a.c. 50 Hz; r.m.s.; 1 min / 1s	2500 (3000)	V
M_1	mounting torque	2,5	Nm
w		30	g
Case	SEMITOP® 3	T56	

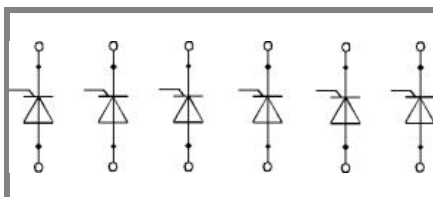

STA

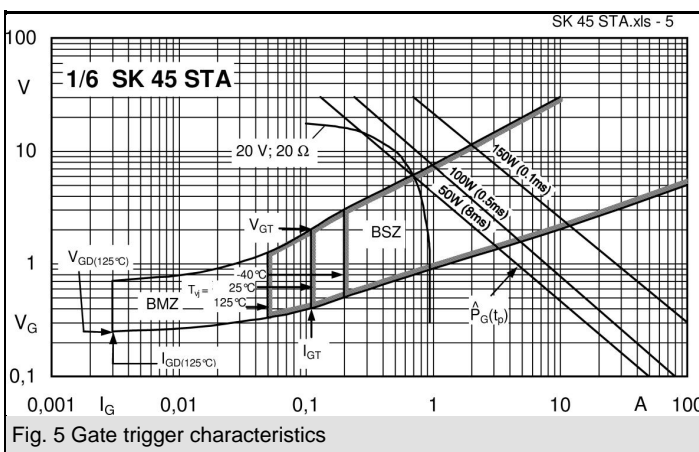
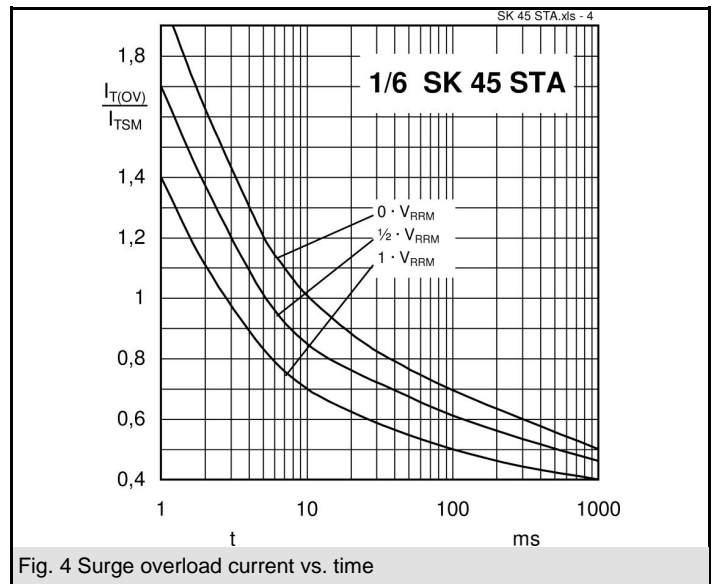
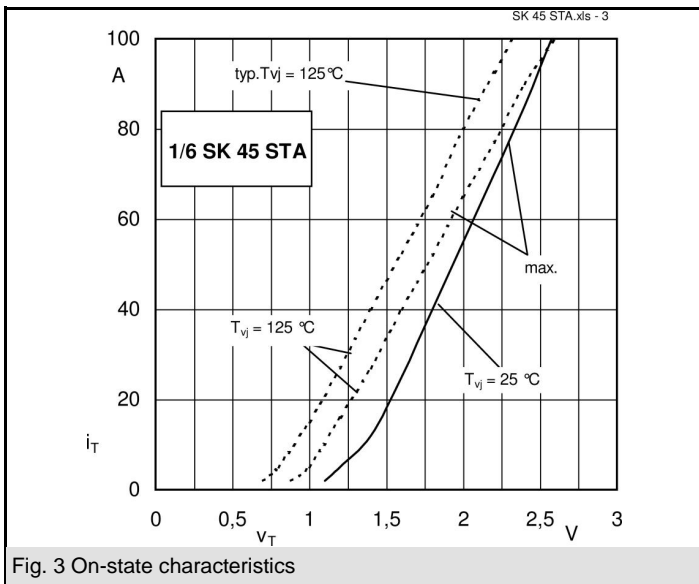
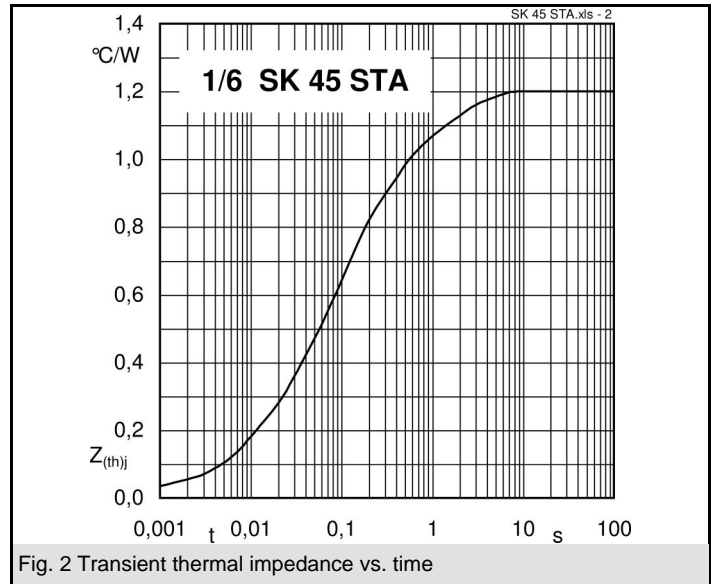
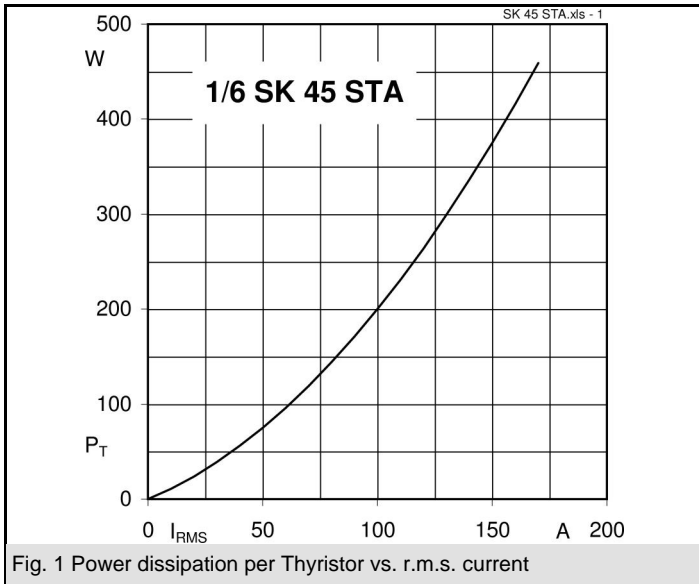

SK 45 STA

UL Recognized
File no. E 63532

Dimensions in mm

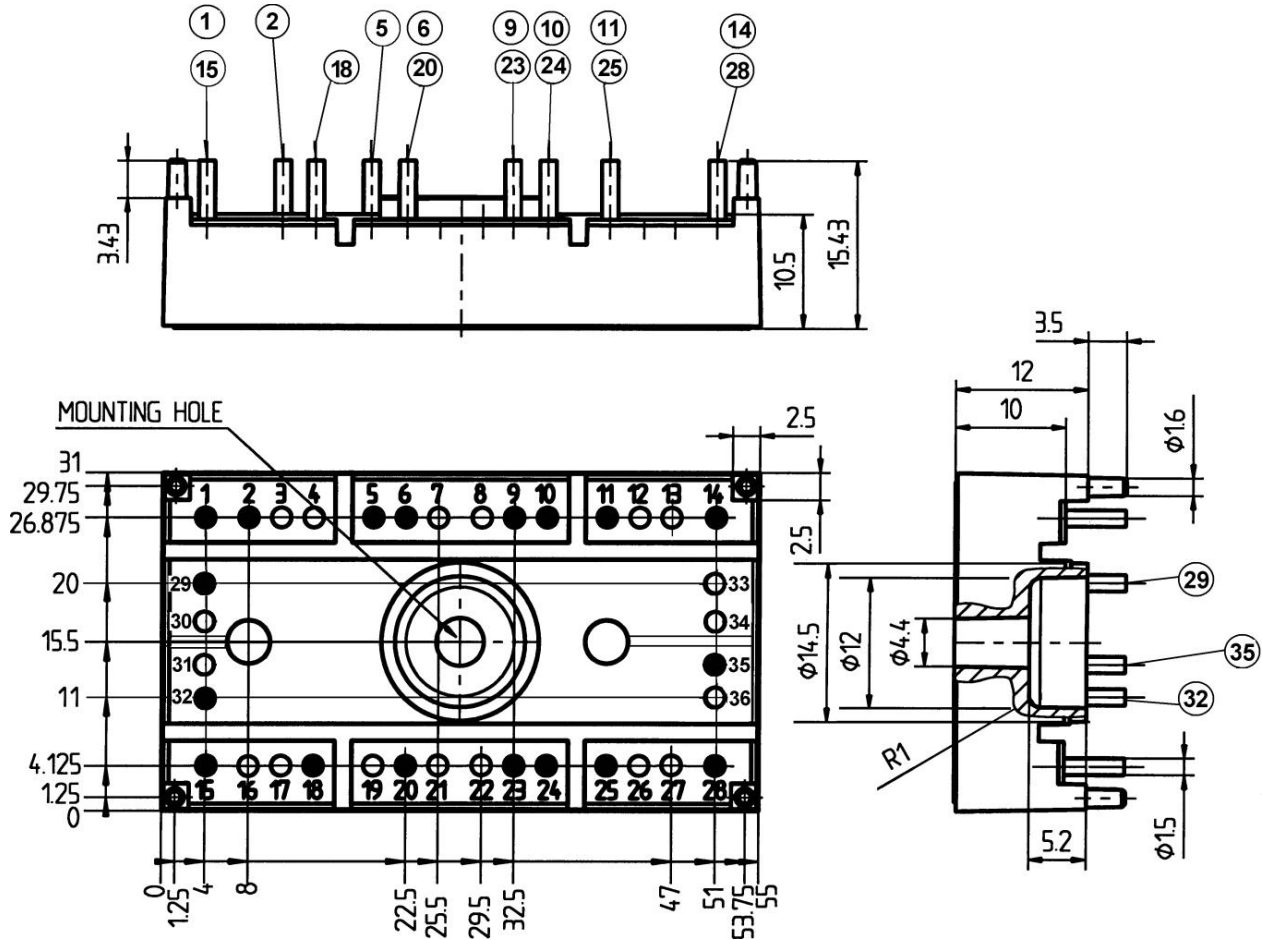

SUGGESTED HOLEDIAMETER FOR THE SOLDER PINS AND THE MOUNTING PINS IN THE PCB: 2 mm

Case T56 (Suggested hole diameter in the PCB for solder pins and mounting pins: 2mm)

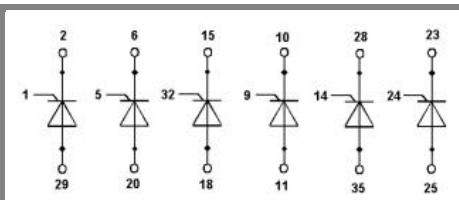

Case T56

This is an electrostatic discharge sensitive device (ESDS), international standard IEC 60747-1, Chapter IX.

* The specifications of our components may not be considered as an assurance of component characteristics. Components have to be tested for the respective application. Adjustments may be necessary. The use of SEMIKRON products in life support appliances and systems is subject to prior specification and written approval by SEMIKRON. We therefore strongly recommend prior consultation of our personal.