

SK 35 NT



SEMITOP®1

Thyristor Module

SK 35 NT

Preliminary Data

Features

- Compact design
- One screw mounting
- Heat transfer and isolation through direct copper bonded aluminium oxide (DCB)
- Glass passivated thyristor chips
- Up to 1600V reverse voltage
- High surge currents
- UL recognized, file no. E 63 532

Typical Applications*

- Soft starters
- Light control (studios, theaters)
- Temperature control

V_{RSM} V	V_{RRM}, V_{DRM} V	$I_{RMS} = (T_h = 80^\circ\text{C})$ A (full conduction) ($T_h = 85^\circ\text{C}$)
900	800	SK 35 NT 08
1300	1200	SK 35 NT 12
1700	1600	SK 35 NT 16

Symbol	Conditions	Values	Units
I_{RMS}	; sin. 180° ; ; sin. 180° ;		A A
I_{TAV}	sin. 180° ; $T_h = 100^\circ\text{C}$	23	A
I_{TAV}	sin. 180° ; $T_h = 85^\circ\text{C}$	33	A
I_{TSM}	$T_{vj} = 25^\circ\text{C}$; 10 ms $T_{vj} = 125^\circ\text{C}$; 10 ms	1000 900	A A
i^2t	$T_{vj} = 25^\circ\text{C}$; 8,3 ... 10 ms $T_{vj} = 125^\circ\text{C}$; 8,3 ... 10 ms	5000 4000	A ² s A ² s
V_T	$T_{vj} = 25^\circ\text{C}$, $I_T = 120$ A	max. 1,8	V
$V_{T(TO)}$	$T_{vj} = 125^\circ\text{C}$	max. 1	V
r_T	$T_{vj} = 125^\circ\text{C}$	max. 6	m Ω
I_{DD}, I_{RD}	$T_{vj} = 25^\circ\text{C}$, $V_{RD} = V_{RRM}$ $T_{vj} = 125^\circ\text{C}$, $V_{RD} = V_{RRM}$	max. 0,5 max. 15	mA mA
t_{gd}	$T_{vj} = 25^\circ\text{C}$, $I_G = 1$ A; $di_G/dt = 1$ A/ μs	1	μs
t_{gr}	$V_D = 0,67 * V_{DRM}$	2	μs
$(dv/dt)_{cr}$	$T_{vj} = 125^\circ\text{C}$	1000	V/ μs
$(di/dt)_{cr}$	$T_{vj} = 125^\circ\text{C}$; $f = 50 \dots 60$ Hz	50	A/ μs
t_q	$T_{vj} = 125^\circ\text{C}$; typ.	80	μs
I_H	$T_{vj} = 25^\circ\text{C}$; typ. / max.	100 / 200	mA
I_L	$T_{vj} = 25^\circ\text{C}$; $R_G = 33 \Omega$; typ. / max.	200 / 400	mA
V_{GT}	$T_{vj} = 25^\circ\text{C}$; d.c.	min. 2	V
I_{GT}	$T_{vj} = 25^\circ\text{C}$; d.c.	min. 100	mA
V_{GD}	$T_{vj} = 125^\circ\text{C}$; d.c.	max. 0,25	V
I_{GD}	$T_{vj} = 125^\circ\text{C}$; d.c.	max. 5	mA
$R_{th(j-h)}$	cont. per thyristor cont. per module	0,8 0,4	K/W K/W
$R_{th(j-h)}$	sin 180° , per thyristor sin 180° per module	0,84 0,42	K/W K/W
T_{vj}		-40 ... +125	$^\circ\text{C}$
T_{stg}		-40 ... +125	$^\circ\text{C}$
T_{solder}	terminals, 10s	260	$^\circ\text{C}$
V_{isol}	a. c. 50 Hz; r.m.s.; 1 s / 1 min.	3000 / 2500	V~
M_s			Nm
M_t	mounting torque	1,5	Nm
a			m/s ²
m		13	g
Case	SEMITOP®1	T9	

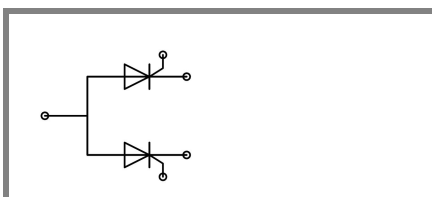

NT

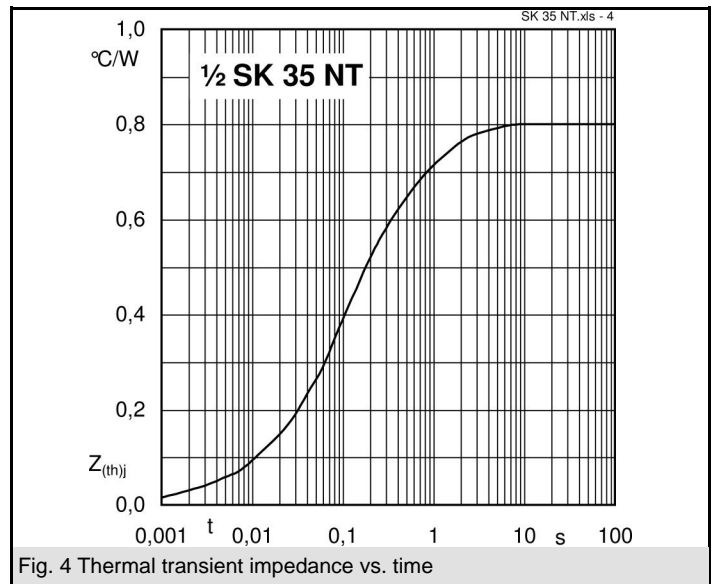
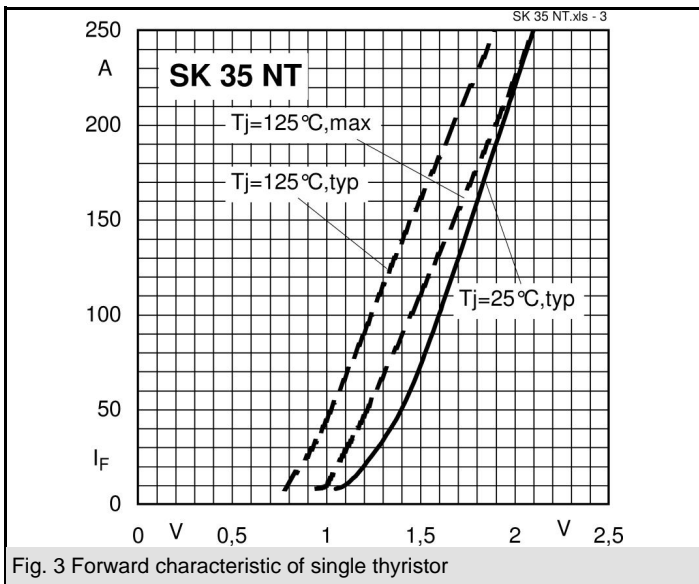
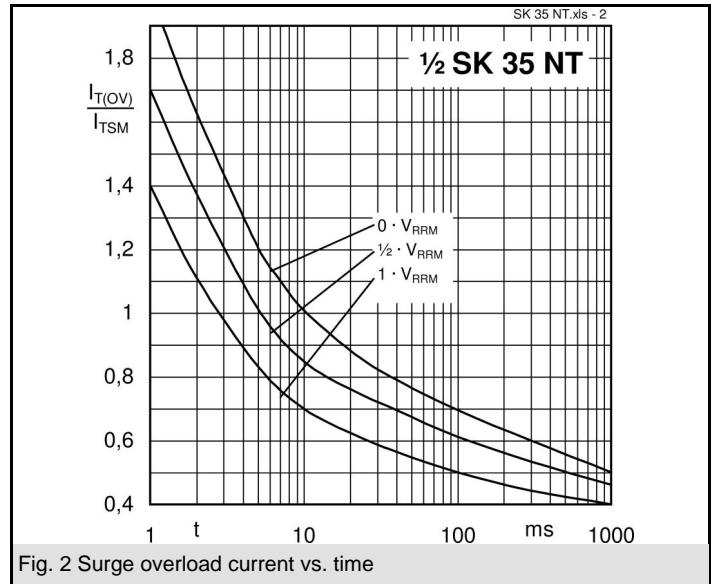
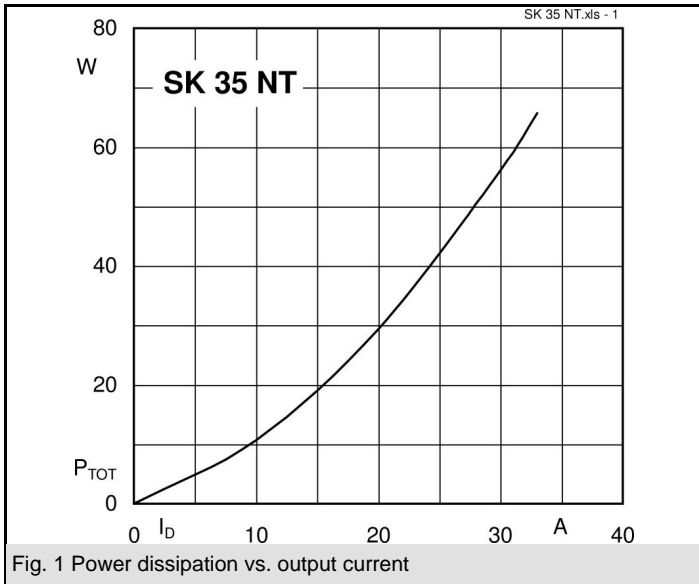

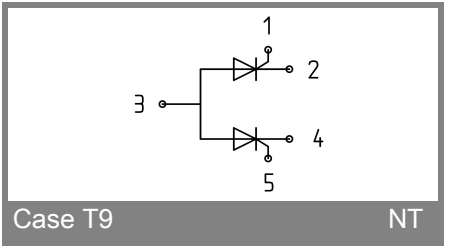
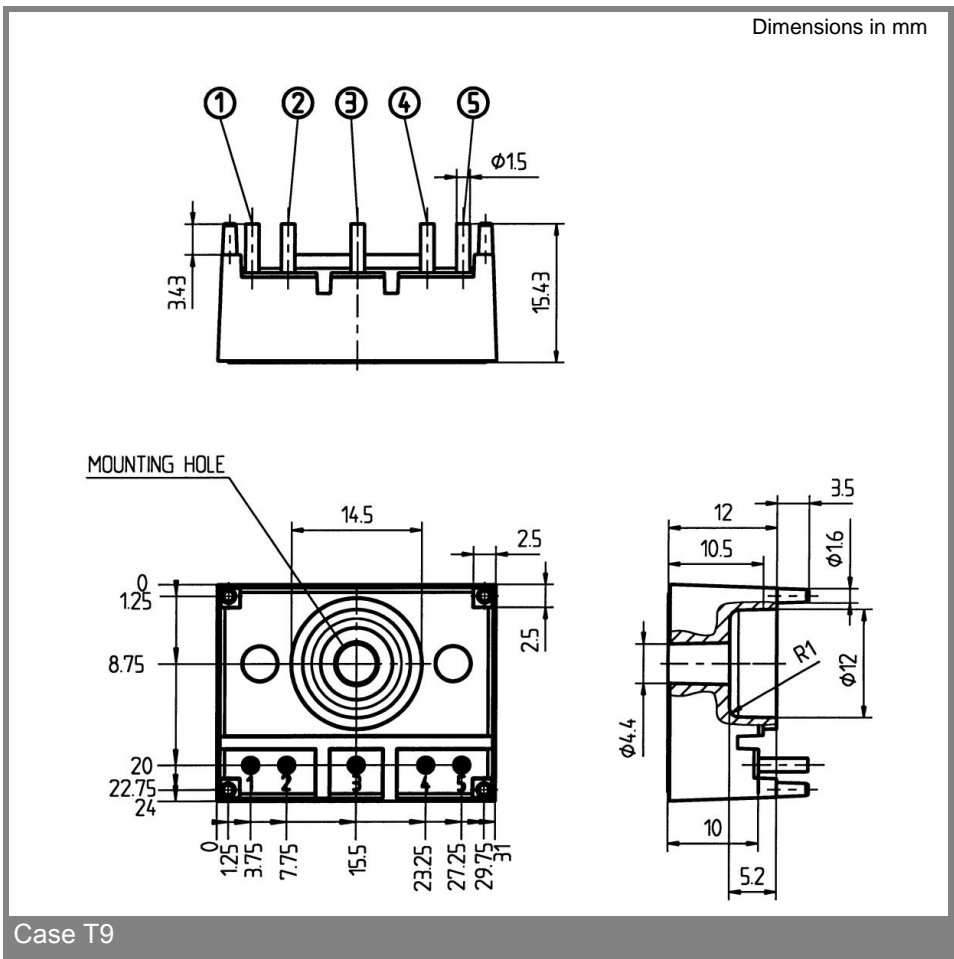
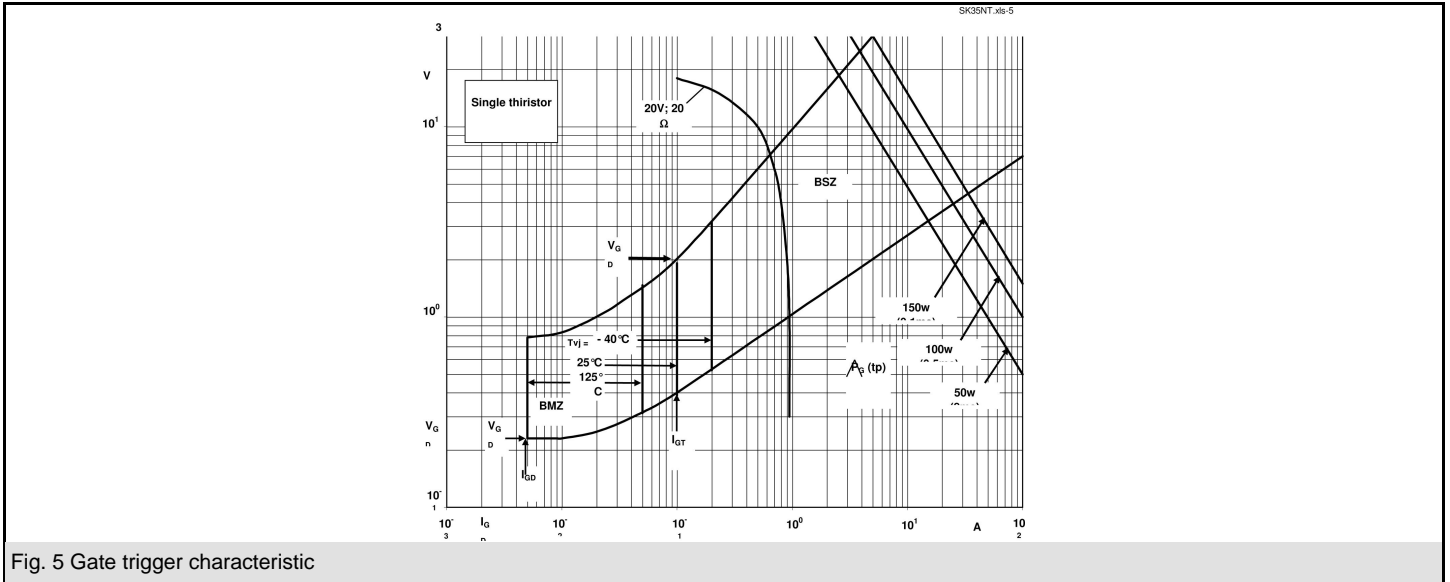

* The specifications of our components may not be considered as an assurance of component characteristics. Components have to be tested for the respective application. Adjustments may be necessary. The use of SEMIKRON products in life support appliances and systems is subject to prior specification and written approval by SEMIKRON. We therefore strongly recommend prior consultation of our personal.