



SEMITOP[®] 2

IGBT Module

SK30GB123

SK30GAL123

SK30GAR123

Preliminary Data

Features

- Compact design
- One screw mounting
- Heat transfer and isolation through direct copper bonded aluminium oxide ceramic (DCB)
- N-channel homogeneous silicon structure (NPT-Non punch-through IGBT)
- High short circuit capability
- Low tail current with low temperature dependence

Typical Applications*

- Switching (not for linear use)
- Inverter
- Switched mode power supplies
- UPS

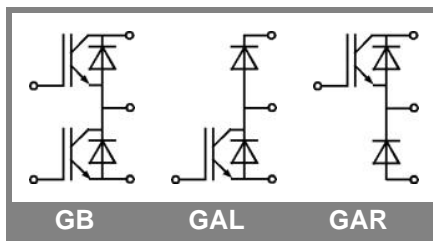

Absolute Maximum Ratings		$T_s = 25\text{ °C}$, unless otherwise specified		
Symbol	Conditions	Values		Units
IGBT				
V_{CES}	$T_j = 25\text{ °C}$	1200		V
I_C	$T_j = 125\text{ °C}$	$T_s = 25\text{ °C}$	33	A
		$T_s = 80\text{ °C}$	22	A
I_{CRM}	$I_{CRM} = 2 \times I_{Cnom}$	50		A
V_{GES}		± 20		V
t_{psc}	$V_{CC} = 600\text{ V}; V_{GE} \leq 20\text{ V}; T_j = 125\text{ °C}$ $V_{CES} < 1200\text{ V}$	10		μs
Inverse Diode				
I_F	$T_j = 150\text{ °C}$	$T_s = 25\text{ °C}$	37	A
		$T_s = 80\text{ °C}$	25	A
I_{FRM}	$I_{FRM} = 2 \times I_{Fnom}$			A
I_{FSM}	$t_p = 10\text{ ms}; \text{half sine wave } T_j = 150\text{ °C}$	350		A
Module				
$I_{t(RMS)}$				A
T_{vj}		-40 ... +150		$^{\circ}\text{C}$
T_{stg}		-40 ... +125		$^{\circ}\text{C}$
V_{isol}	AC, 1 min.	2500		V

Characteristics		$T_s = 25\text{ °C}$, unless otherwise specified				
Symbol	Conditions	min.	typ.	max.	Units	
IGBT						
$V_{GE(th)}$	$V_{GE} = V_{CE}, I_C = 1\text{ mA}$	4,5	5,5	6,5	V	
I_{CES}	$V_{GE} = 0\text{ V}, V_{CE} = V_{CES}$	$T_j = 25\text{ °C}$	0,15		mA	
		$T_j = 125\text{ °C}$			mA	
I_{GES}	$V_{CE} = 0\text{ V}, V_{GE} = 30\text{ V}$	$T_j = 25\text{ °C}$	120		nA	
		$T_j = 125\text{ °C}$			nA	
V_{CE0}		$T_j = 25\text{ °C}$	1,2		V	
		$T_j = 125\text{ °C}$	1,2		V	
r_{CE}	$V_{GE} = 15\text{ V}$	$T_j = 25\text{ °C}$	52		$\text{m}\Omega$	
		$T_j = 125\text{ °C}$	76		$\text{m}\Omega$	
$V_{CE(sat)}$	$I_{Cnom} = 25\text{ A}, V_{GE} = 15\text{ V}$	$T_j = 25\text{ °C}_{chiplev.}$	2	2,5	3	V
		$T_j = 125\text{ °C}_{chiplev.}$		3,1	3,7	V
C_{ies}	$V_{CE} = 25, V_{GE} = 0\text{ V}$	$f = 1\text{ MHz}$	1,65		nF	
C_{oes}			0,25		nF	
C_{res}			0,11		nF	
$t_{d(on)}$	$R_{Gon} = 25\ \Omega$	$V_{CC} = 600\text{ V}$ $I_C = 25\text{ A}$	40		ns	
t_r			45		ns	
E_{on}	$R_{Goff} = 25\ \Omega$	$T_j = 125\text{ °C}$ $V_{GE} = \pm 15\text{ V}$	3,5		mJ	
$t_{d(off)}$			300		ns	
t_f			45		ns	
E_{off}			2,6		mJ	
$R_{th(j-s)}$	per IGBT			1	K/W	



SEMITOP® 2

IGBT Module

SK30GB123

SK30GAL123

SK30GAR123

Preliminary Data

Features

- Compact design
- One screw mounting
- Heat transfer and isolation through direct copper bonded aluminium oxide ceramic (DCB)
- N-channel homogeneous silicon structure (NPT-Non punch-through IGBT)
- High short circuit capability
- Low tail current with low temperature dependence

Typical Applications*

- Switching (not for linear use)
- Inverter
- Switched mode power supplies
- UPS

Characteristics

Symbol	Conditions	min.	typ.	max.	Units
Inverse Diode					
$V_F = V_{EC}$	$I_{Fnom} = 25 \text{ A}; V_{GE} = 0 \text{ V}$		2	2,5	V
			1,8	2,3	V
V_{F0}			1	1,2	V
r_F			32	44	mΩ
I_{RRM}	$I_F = 22 \text{ A}$		25		A
Q_{rr}	$di/dt = -500 \text{ A}/\mu\text{s}$		4,5		μC
E_{rr}	$V_{CC} = 600\text{V}$		1		mJ
$R_{th(j-s)D}$	per diode			1,2	K/W
M_s	to heat sink M1			2	Nm
w			19		g

This is an electrostatic discharge sensitive device (ESDS), international standard IEC 60747-1, Chapter IX.

* The specifications of our components may not be considered as an assurance of component characteristics. Components have to be tested for the respective application. Adjustments may be necessary. The use of SEMIKRON products in life support appliances and systems is subject to prior specification and written approval by SEMIKRON. We therefore strongly recommend prior consultation of our personal.

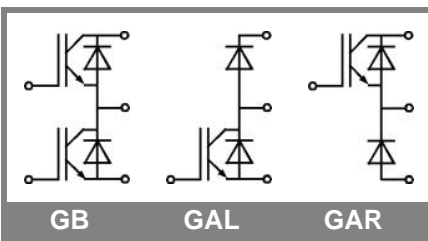

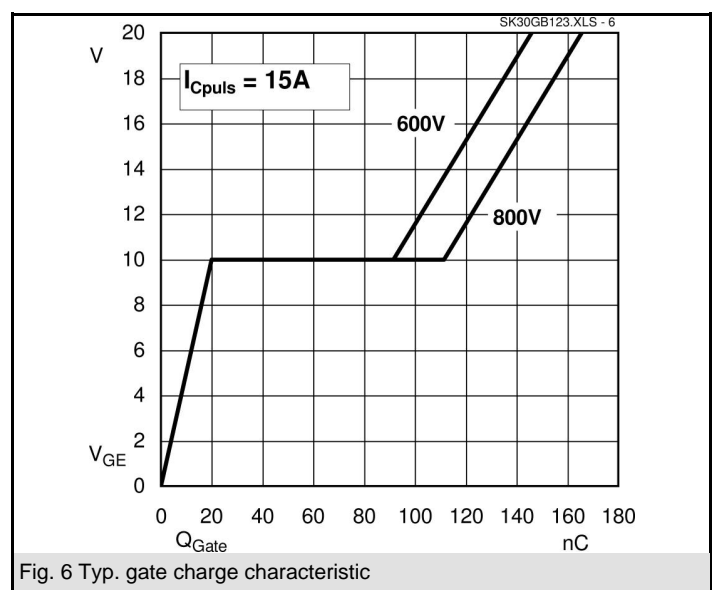
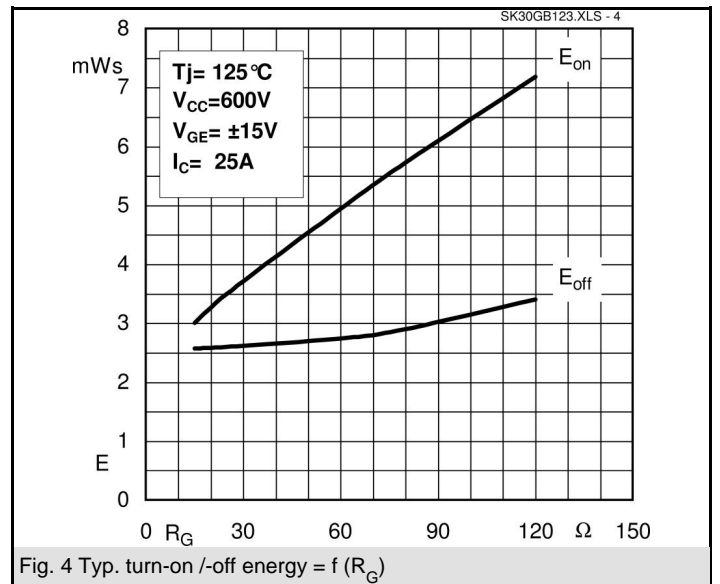
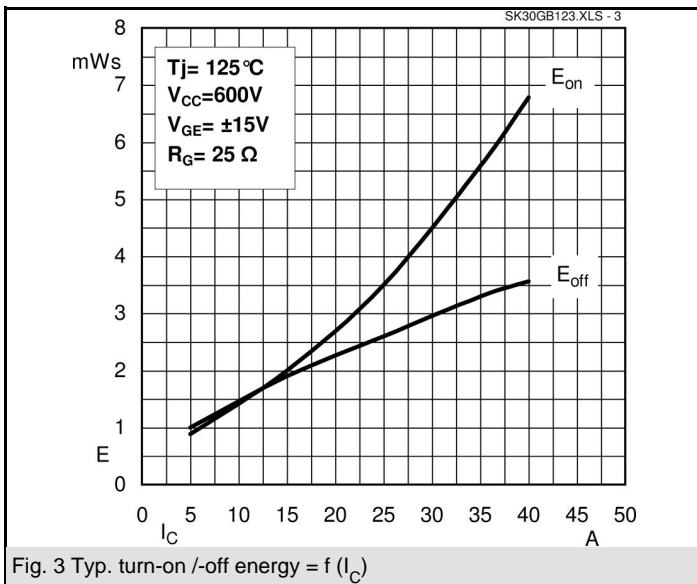
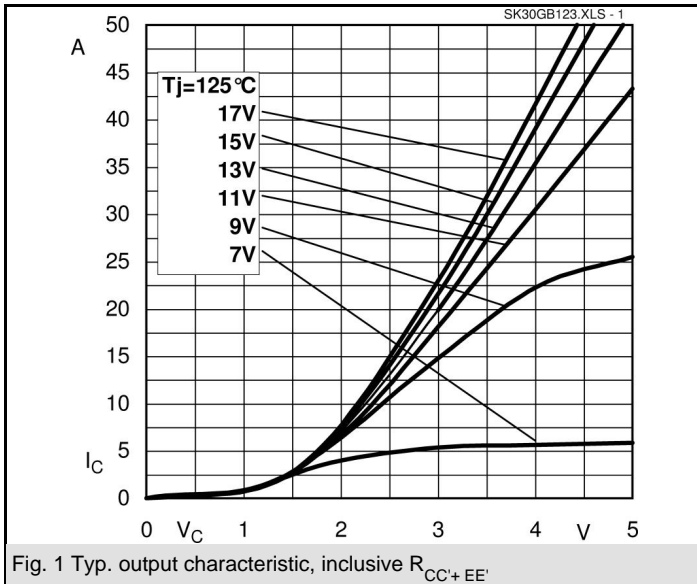

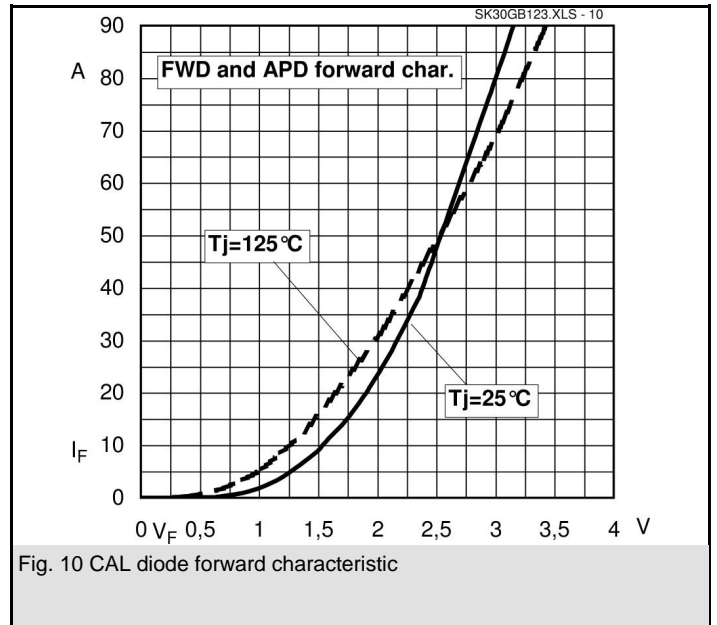
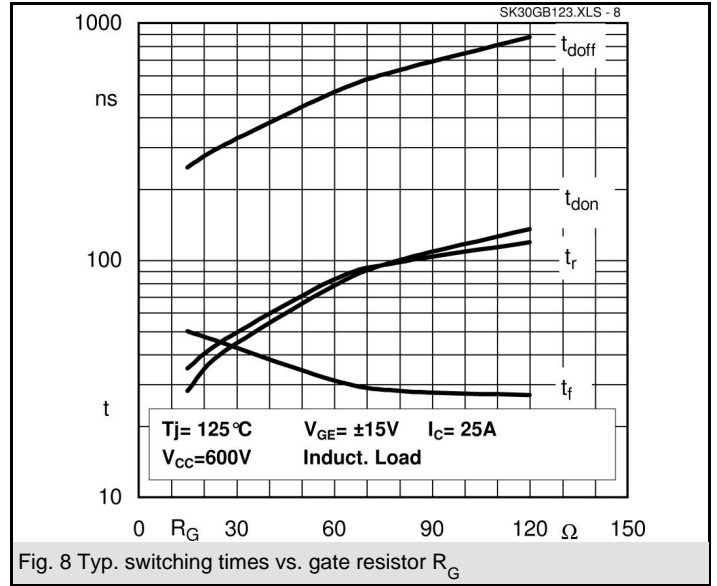
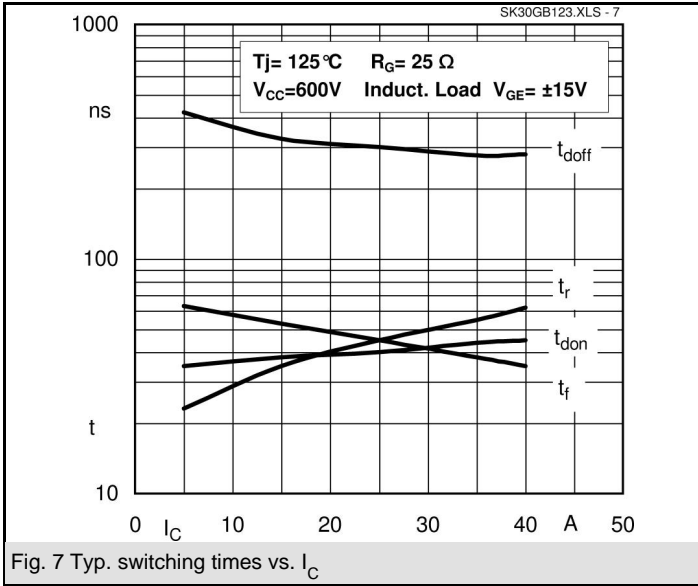

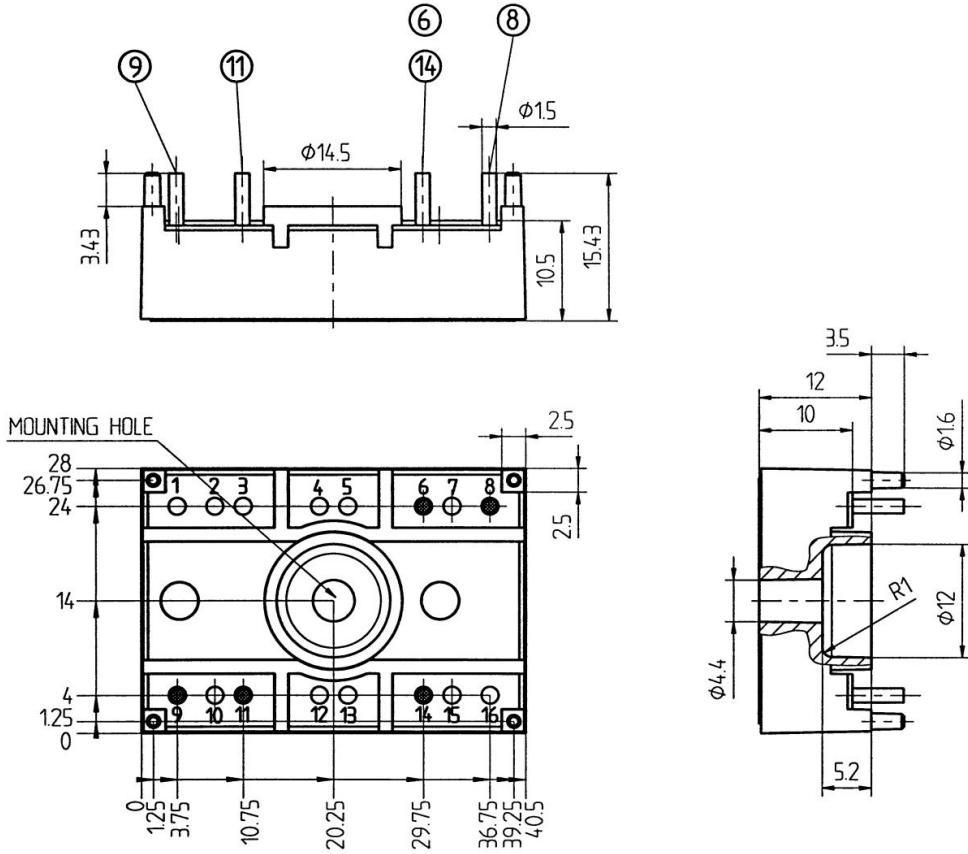

Case T8 (Suggested hole diameter, in the PCB, for solder pins and plastic mounting pins: 2mm)

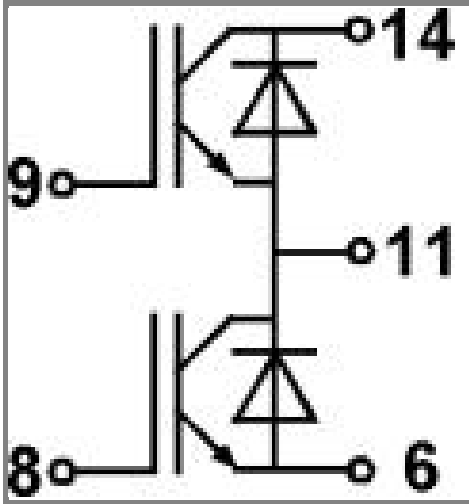

Case T8

GB

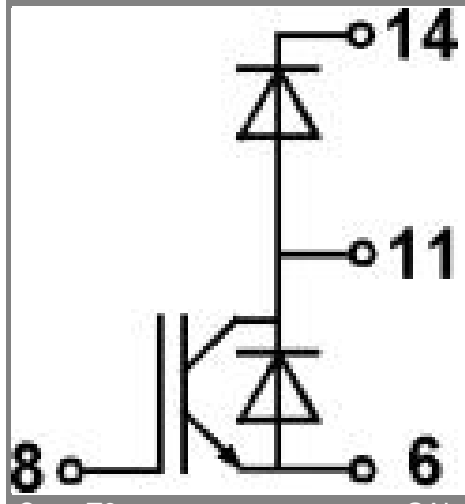

Case T8

GAL

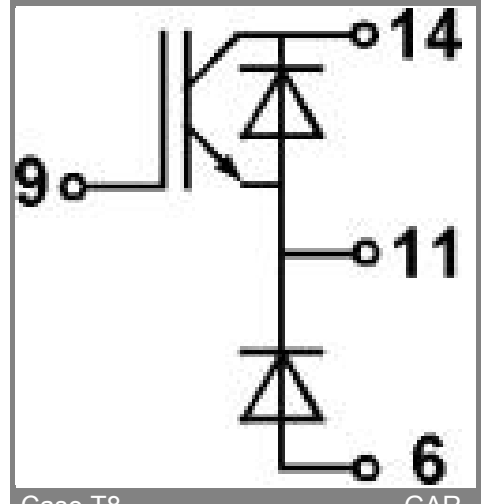

Case T8

GAR