

## IGBT Module

SK20MLI066

### Target Data

### Features

- Compact design
- One screw mounting
- Heat transfer and isolation through direct copper bonded aluminium oxide ceramic (DCB)
- Trench IGBT technology
- CAL technology FWD

### Typical Applications\*

- 3 Level Inverter
- UPS

### Remarks

- Visol = 3000V AC, 1s, 50Hz
- Dynamic measure: DUT= IGBT (Gate pin 1) and Neutral Clamp Diode (Kathode pin 16) as free-wheeling diode

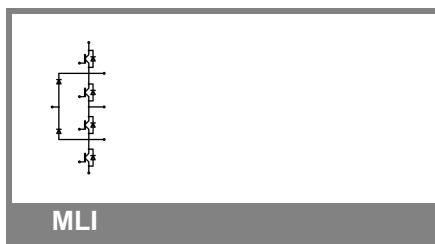

MLI

Absolute Maximum Ratings		$T_s = 25\text{ }^\circ\text{C}$ , unless otherwise specified	
Symbol	Conditions	Values	Units
<b>IGBT</b>			
$V_{CES}$	$T_j = 25\text{ }^\circ\text{C}$	600	V
$I_C$	$T_j = 175\text{ }^\circ\text{C}$	$T_s = 25\text{ }^\circ\text{C}$	30
		$T_s = 70\text{ }^\circ\text{C}$	24
$I_{CRM}$	$I_{CRM} = 2 \times I_{Cnom}$	40	A
$V_{GES}$		$\pm 20$	V
$t_{psc}$	$V_{CC} = 360\text{ V}; V_{GE} \leq 20\text{ V}; T_j = 150\text{ }^\circ\text{C}$ $V_{CES} < 600\text{ V}$	6	$\mu\text{s}$

Inverse Diode		$T_s = 25\text{ }^\circ\text{C}$ , unless otherwise specified	
Symbol	Conditions	Values	Units
$I_F$	$T_j = 175\text{ }^\circ\text{C}$	$T_s = 25\text{ }^\circ\text{C}$	30
		$T_s = 70\text{ }^\circ\text{C}$	24
$I_{FRM}$	$I_{FRM} = 2 \times I_{Fnom}$	40	A
$I_{FSM}$	$t_p = 10\text{ ms};$ half sine wave $T_j = 150\text{ }^\circ\text{C}$	95	A

Freewheeling Diode		$T_s = 25\text{ }^\circ\text{C}$ , unless otherwise specified	
Symbol	Conditions	Values	Units
$I_F$	$T_j = 175\text{ }^\circ\text{C}$	$T_s = 25\text{ }^\circ\text{C}$	31
		$T_s = 70\text{ }^\circ\text{C}$	24
$I_{FRM}$	$I_{FRM} = 2 \times I_{Fnom}$	40	A
$I_{FSM}$	$t_p = 10\text{ ms};$ half sine wave $T_j = 150\text{ }^\circ\text{C}$	95	A

Module		$T_s = 25\text{ }^\circ\text{C}$ , unless otherwise specified	
Symbol	Conditions	Values	Units
$I_{t(RMS)}$			A
$T_{vj}$		-40 ... +175	$^\circ\text{C}$
$T_{stg}$		-40 ... +125	$^\circ\text{C}$
$V_{isol}$	AC, 1 min.	2500	V

Characteristics		$T_s = 25\text{ }^\circ\text{C}$ , unless otherwise specified			
Symbol	Conditions	min.	typ.	max.	Units
<b>IGBT</b>					
$V_{GE(th)}$	$V_{GE} = V_{CE}, I_C = 0,29\text{ mA}$	5	5,8	6,5	V
$I_{CES}$	$V_{GE} = 0\text{ V}, V_{CE} = V_{CES}$ $T_j = 25\text{ }^\circ\text{C}$			0,0011	mA
$I_{GES}$	$V_{CE} = 0\text{ V}, V_{GE} = 20\text{ V}$ $T_j = 25\text{ }^\circ\text{C}$			300	nA
$V_{CE0}$			$T_j = 25\text{ }^\circ\text{C}$	0,9	1,1
			$T_j = 150\text{ }^\circ\text{C}$	0,8	1
$r_{CE}$	$V_{GE} = 15\text{ V}$		$T_j = 25\text{ }^\circ\text{C}$	27,5	37,5
			$T_j = 150\text{ }^\circ\text{C}$	40	52,5
$V_{CE(sat)}$	$I_{Cnom} = 20\text{ A}, V_{GE} = 15\text{ V}$		$T_j = 25\text{ }^\circ\text{C}_{chiplev.}$	1,45	1,85
			$T_j = 150\text{ }^\circ\text{C}_{chiplev.}$	1,65	2,05
$C_{ies}$	$V_{CE} = 25, V_{GE} = 0\text{ V}$	$f = 1\text{ MHz}$		1,1	nF
$C_{oes}$			0,071	nF	
$C_{res}$			0,032	nF	
$t_{d(on)}$	$R_{Gon} = 33\ \Omega$	$V_{CC} = 300\text{ V}$ $I_C = 20\text{ A}$		21	ns
$t_r$				19	ns
$E_{on}$	$R_{Goff} = 33\ \Omega$	$T_j = 150\text{ }^\circ\text{C}$ $V_{GE} = -7/+15\text{ V}$		0,4	mJ
$t_{d(off)}$				230	ns
$t_f$				50	ns
$E_{off}$				1,07	mJ
$R_{th(j-s)}$	per IGBT		1,95		K/W

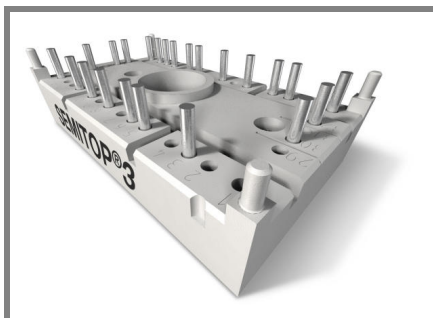

**SEMITOP<sup>®</sup> 3**

## IGBT Module

**SK20MLI066**

### Target Data

### Features

- Compact design
- One screw mounting
- Heat transfer and isolation through direct copper bonded aluminium oxide ceramic (DCB)
- Trench IGBT technology
- CAL technology FWD

### Typical Applications\*

- 3 Level Inverter
- UPS

### Remarks

- Visol = 3000V AC, 1s, 50Hz
- Dynamic measure: DUT= IGBT (Gate pin 1) and Neutral Clamp Diode (Kathode pin 16) as free-wheeling diode



MLI

## Characteristics

Symbol	Conditions	min.	typ.	max.	Units
<b>Inverse Diode (Antiparallel Diode)</b>					
$V_F = V_{EC}$	$I_{Fnom} = 20 \text{ A}; V_{GE} = 0 \text{ V}$				
	$T_j = 25 \text{ }^\circ\text{C}_{chiplev.}$		1,6	1,9	V
	$T_j = 150 \text{ }^\circ\text{C}_{chiplev.}$		1,65	1,95	V
$V_{F0}$					
	$T_j = 25 \text{ }^\circ\text{C}$		1	1,1	V
	$T_j = 150 \text{ }^\circ\text{C}$		0,9	1	V
$r_F$					
	$T_j = 25 \text{ }^\circ\text{C}$		30	40	mΩ
	$T_j = 150 \text{ }^\circ\text{C}$		37,5	47,5	mΩ
$I_{RRM}$	$I_F = 20 \text{ A}$				A
$Q_{rr}$	$di/dt = -2000 \text{ A}/\mu\text{s}$				μC
$E_{rr}$	$V_R = 300 \text{ V}$		0,2		mJ
$R_{th(j-s)D}$	per diode		2,46		K/W
<b>Freewheeling Diode (Neutral Clamp diode)</b>					
$V_F = V_{EC}$	$I_{Fnom} = 20 \text{ A}; V_{GE} = 0 \text{ V}$				
	$T_j = 25 \text{ }^\circ\text{C}_{chiplev.}$		1,5		V
	$T_j = 150 \text{ }^\circ\text{C}_{chiplev.}$		1,5		V
$V_{F0}$					
	$T_j = 25 \text{ }^\circ\text{C}$		1		V
	$T_j = 150 \text{ }^\circ\text{C}$		0,9		V
$r_F$					
	$T_j = 25 \text{ }^\circ\text{C}$		20		V
	$T_j = 150 \text{ }^\circ\text{C}$		25		V
$I_{RRM}$	$I_F = 20 \text{ A}$		20		A
$Q_{rr}$	$di/dt = -2000 \text{ A}/\mu\text{s}$		1		μC
$E_{rr}$	$V_R = 300 \text{ V}$		0,2		mJ
$R_{th(j-s)FD}$	per diode		2,46		K/W
$M_s$	to heat sink	2,25		2,5	Nm
w			30		g

This is an electrostatic discharge sensitive device (ESDS), international standard IEC 60747-1, Chapter IX.

\* The specifications of our components may not be considered as an assurance of component characteristics. Components have to be tested for the respective application. Adjustments may be necessary. The use of SEMIKRON products in life support appliances and systems is subject to prior specification and written approval by SEMIKRON. We therefore strongly recommend prior consultation of our personal.

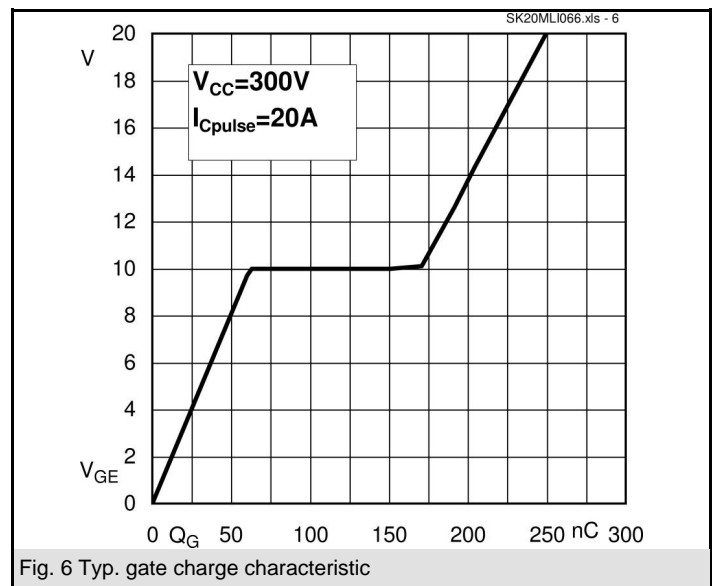
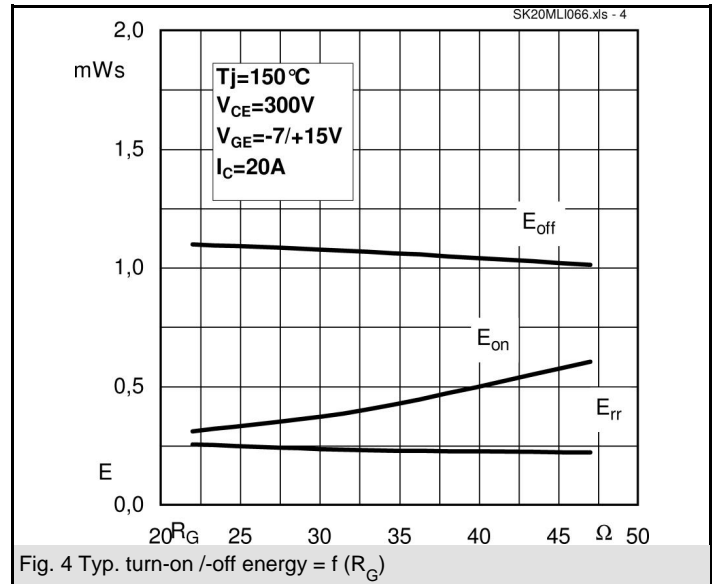
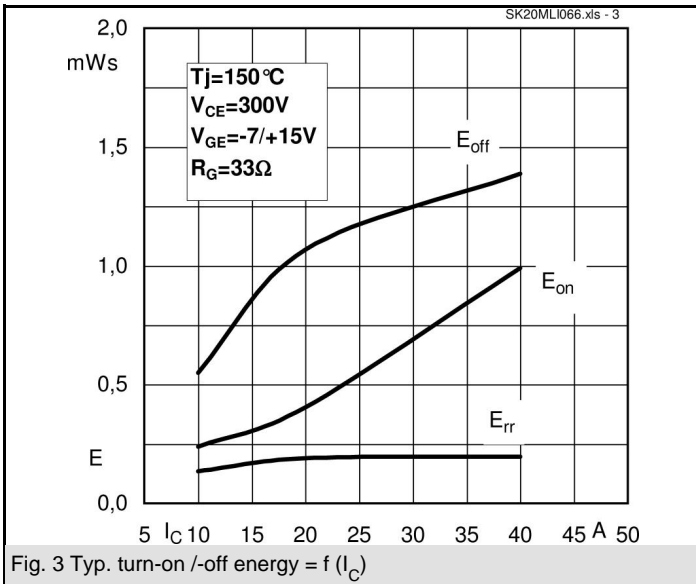
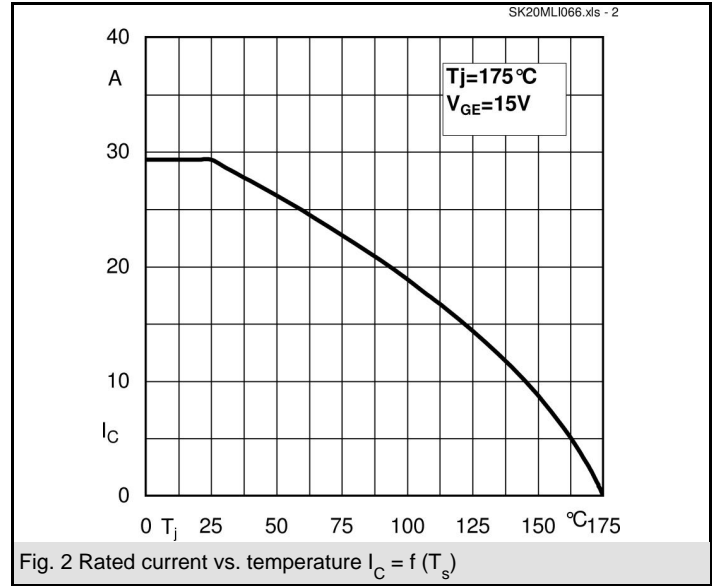
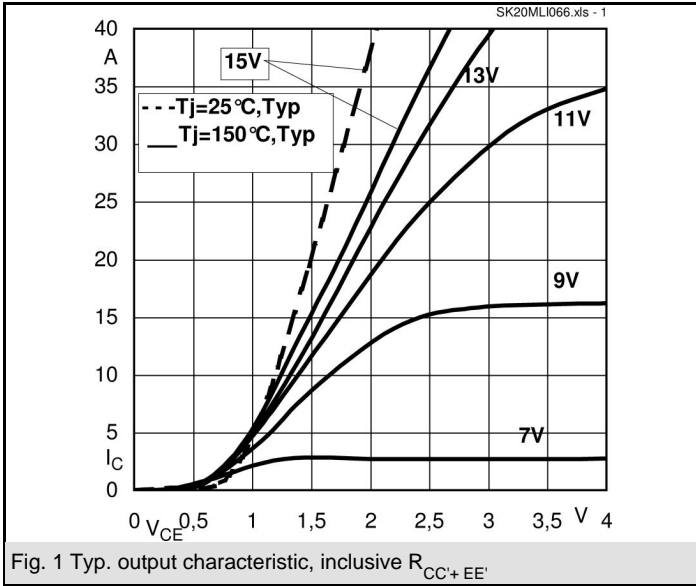

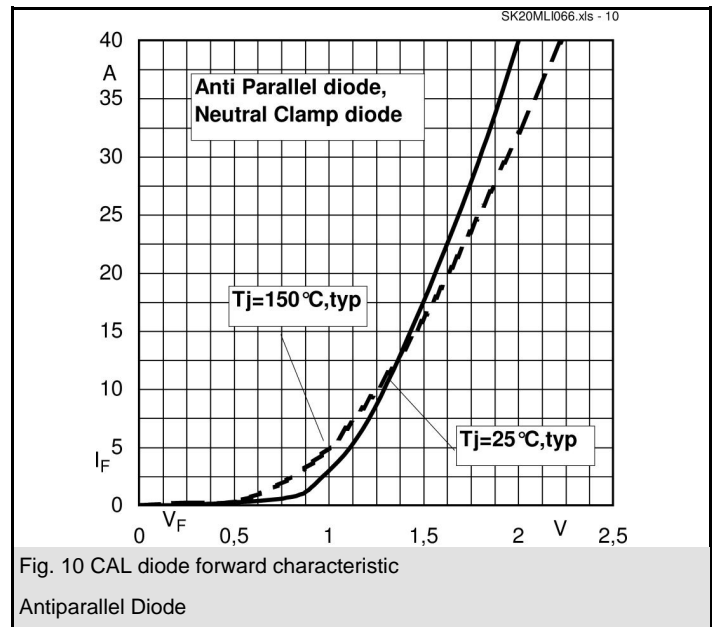
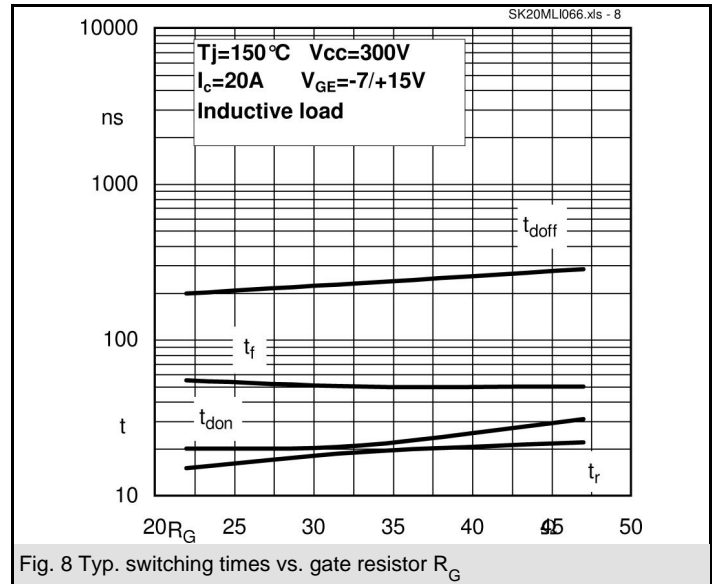
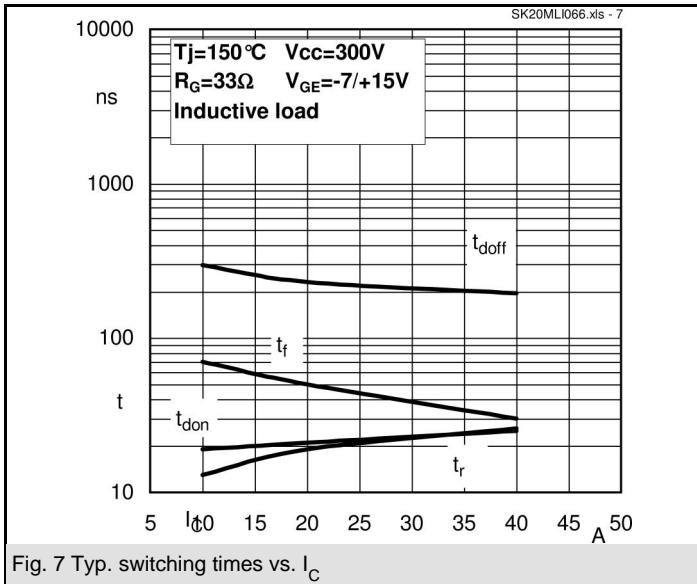

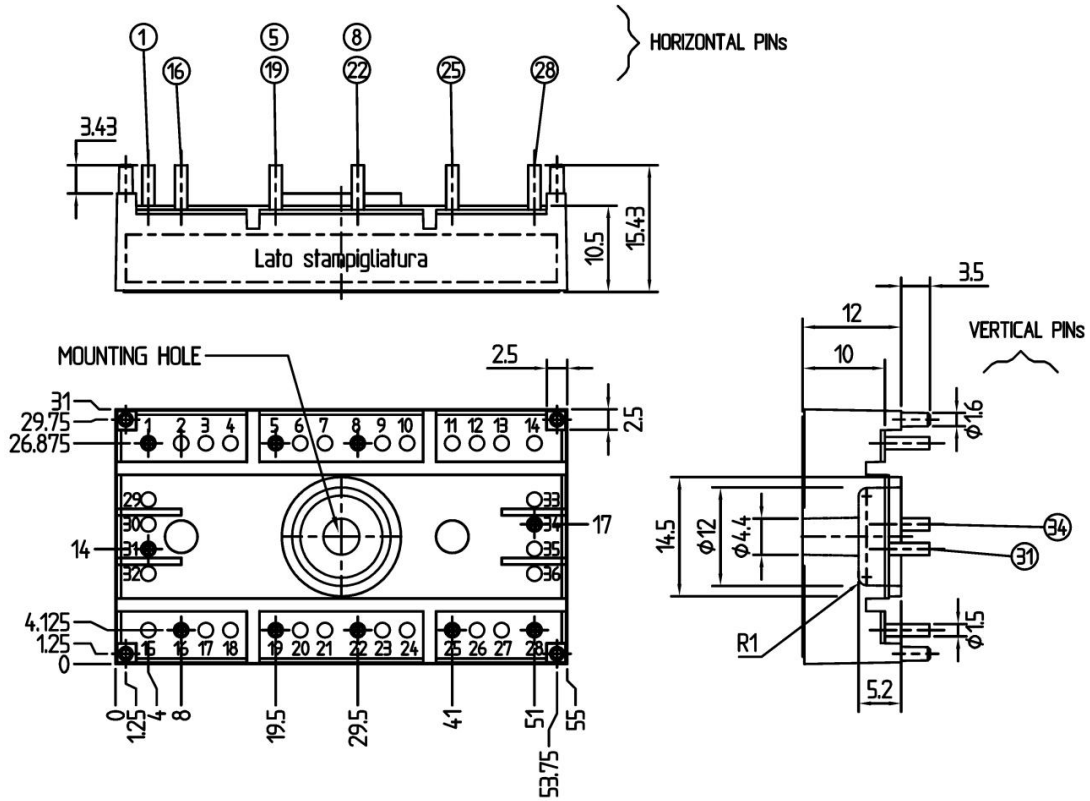

Case T 76 (Suggested hole diameter, in the PCB, for solder pins and plastic mounting pins: 2mm)

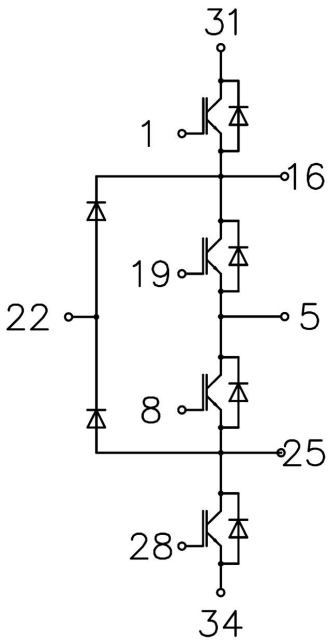

Case T 76

MLI