

# SEMiX303GB12Vs



SEMiX® 3s

## SEMiX303GB12Vs

### Features

- Homogeneous Si
- $V_{CE(sat)}$  with positive temperature coefficient
- High short circuit capability
- UL recognised file no. E63532

### Typical Applications\*

- AC inverter drives
- UPS
- Electronic Welding

### Remarks

- Case temperature limited to  $T_C=125^\circ\text{C}$  max.
- Product reliability results are valid for  $T_j=150^\circ\text{C}$
- Dynamic values apply to the following combination of resistors:  
 $R_{Gon,main} = 1,0 \Omega$   
 $R_{Goff,main} = 1,0 \Omega$   
 $R_{G,X} = 2,2 \Omega$   
 $R_{E,X} = 1,0 \Omega$

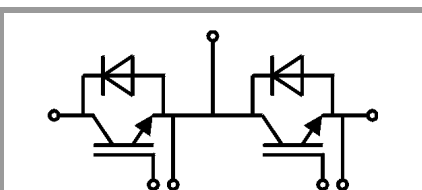

GB

### Absolute Maximum Ratings

Symbol	Conditions	Values	Unit	
<b>IGBT</b>				
$V_{CES}$		1200	V	
$I_C$	$T_j = 175^\circ\text{C}$	$T_c = 25^\circ\text{C}$	448	A
		$T_c = 80^\circ\text{C}$	342	A
$I_{Cnom}$		300	A	
$I_{CRM}$	$I_{CRM} = 3 \times I_{Cnom}$	900	A	
$V_{GES}$		-20 ... 20	V	
$t_{psc}$	$V_{CC} = 600\text{ V}$	$T_j = 125^\circ\text{C}$	10	$\mu\text{s}$
	$V_{GE} \leq 15\text{ V}$			
	$V_{CES} \leq 1200\text{ V}$			
$T_j$		-40 ... 175	$^\circ\text{C}$	
<b>Inverse diode</b>				
$I_F$	$T_j = 175^\circ\text{C}$	$T_c = 25^\circ\text{C}$	327	A
		$T_c = 80^\circ\text{C}$	244	A
$I_{Fnom}$		300	A	
$I_{FRM}$	$I_{FRM} = 3 \times I_{Fnom}$	900	A	
$I_{FSM}$	$t_p = 10\text{ ms, sin } 180^\circ, T_j = 25^\circ\text{C}$	1485	A	
$T_j$		-40 ... 175	$^\circ\text{C}$	
<b>Module</b>				
$I_{t(RMS)}$	$T_{terminal} = 80^\circ\text{C}$	600	A	
$T_{stg}$		-40 ... 125	$^\circ\text{C}$	
$V_{isol}$	AC sinus 50Hz, $t = 1\text{ min}$	4000	V	

### Characteristics

Symbol	Conditions	min.	typ.	max.	Unit
<b>IGBT</b>					
$V_{CE(sat)}$	$I_C = 300\text{ A}$ $V_{GE} = 15\text{ V}$ chipllevel	$T_j = 25^\circ\text{C}$	1.75	2.2	V
		$T_j = 150^\circ\text{C}$	2.2	2.5	V
$V_{CE0}$		$T_j = 25^\circ\text{C}$	0.94	1.04	V
		$T_j = 150^\circ\text{C}$	0.88	0.98	V
$r_{CE}$	$V_{GE} = 15\text{ V}$	$T_j = 25^\circ\text{C}$	2.7	3.9	$\text{m}\Omega$
		$T_j = 150^\circ\text{C}$	4.4	5.1	$\text{m}\Omega$
$V_{GE(th)}$	$V_{GE}=V_{CE}, I_C = 12\text{ mA}$	5.5	6	6.5	V
$I_{CES}$	$V_{GE} = 0\text{ V}$ $V_{CE} = 1200\text{ V}$	$T_j = 25^\circ\text{C}$	0.1	0.3	$\text{mA}$
		$T_j = 150^\circ\text{C}$			$\text{mA}$
$C_{ies}$	$V_{CE} = 25\text{ V}$		18.0		nF
$C_{oes}$	$V_{GE} = 0\text{ V}$		1.77		nF
$C_{res}$			1.77		nF
$Q_G$	$V_{GE} = -8\text{ V...} + 15\text{ V}$		3300		nC
$R_{Gint}$	$T_j = 25^\circ\text{C}$		2.50		$\Omega$
$t_{d(on)}$	$V_{CC} = 600\text{ V}$ $I_C = 300\text{ A}$	$T_j = 150^\circ\text{C}$	470		ns
$t_r$	$V_{GE} = \pm 15\text{ V}$	$T_j = 150^\circ\text{C}$	72		ns
$E_{on}$	$R_{Gon} = 2.1\ \Omega$	$T_j = 150^\circ\text{C}$	26.5		mJ
$t_{d(off)}$	$R_{Goff} = 2.1\ \Omega$	$T_j = 150^\circ\text{C}$	665		ns
$t_f$	$di/dt_{on} = 4200\text{ A}/\mu\text{s}$	$T_j = 150^\circ\text{C}$	109		ns
$E_{off}$	$di/dt_{off} = 2600\text{ A}/\mu\text{s}$	$T_j = 150^\circ\text{C}$	36.3		mJ
	$du/dt_{off} = 6600\text{ V}/\mu\text{s}$				
$R_{th(j-c)}$	per IGBT			0.1	K/W

# SEMiX303GB12Vs



SEMiX® 3s

## SEMiX303GB12Vs

### Features

- Homogeneous Si
- $V_{CE(sat)}$  with positive temperature coefficient
- High short circuit capability
- UL recognised file no. E63532

### Typical Applications\*

- AC inverter drives
- UPS
- Electronic Welding

### Remarks

- Case temperature limited to  $T_C=125^\circ\text{C}$  max.
- Product reliability results are valid for  $T_j=150^\circ\text{C}$
- Dynamic values apply to the following combination of resistors:  
 $R_{Gon,main} = 1,0 \Omega$   
 $R_{Goff,main} = 1,0 \Omega$   
 $R_{G,X} = 2,2 \Omega$   
 $R_{E,X} = 1,0 \Omega$

Characteristics						
Symbol	Conditions		min.	typ.	max.	Unit
<b>Inverse diode</b>						
$V_F = V_{EC}$	$I_F = 300 \text{ A}$ $V_{GE} = 0 \text{ V}$ chip	$T_j = 25^\circ\text{C}$		2.2	2.52	V
		$T_j = 150^\circ\text{C}$		2.2	2.5	V
$V_{F0}$		$T_j = 25^\circ\text{C}$	1.1	1.3	1.5	V
		$T_j = 150^\circ\text{C}$	0.7	0.9	1.1	V
$r_F$		$T_j = 25^\circ\text{C}$	2.7	3.0	3.4	m $\Omega$
		$T_j = 150^\circ\text{C}$	3.5	4.2	4.6	m $\Omega$
$I_{RRM}$	$I_F = 300 \text{ A}$	$T_j = 150^\circ\text{C}$		283		A
$Q_{rr}$	$di/dt_{off} = 4600 \text{ A}/\mu\text{s}$	$T_j = 150^\circ\text{C}$		52		$\mu\text{C}$
$E_{rr}$	$V_{GE} = -15 \text{ V}$ $V_{CC} = 600 \text{ V}$	$T_j = 150^\circ\text{C}$		21.4		mJ
$R_{th(j-c)}$	per diode				0.19	K/W
<b>Module</b>						
$L_{CE}$				20		nH
$R_{CC'+EE'}$	res., terminal-chip	$T_C = 25^\circ\text{C}$		0.7		m $\Omega$
		$T_C = 125^\circ\text{C}$		1		m $\Omega$
$R_{th(c-s)}$	per module			0.04		K/W
$M_s$	to heat sink (M5)		3		5	Nm
$M_t$		to terminals (M6)	2.5		5	Nm
						Nm
$w$					300	g
<b>Temperatur Sensor</b>						
$R_{100}$	$T_C=100^\circ\text{C}$ ( $R_{25}=5 \text{ k}\Omega$ )			$493 \pm 5\%$		$\Omega$
$B_{100/125}$	$R(T)=R_{100}\exp[B_{100/125}(1/T-1/T_{100})]$ ; T[K];			$3550 \pm 2\%$		K

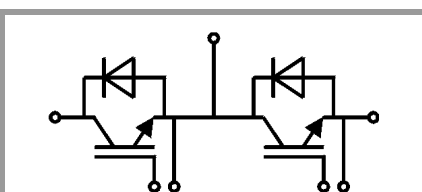

GB

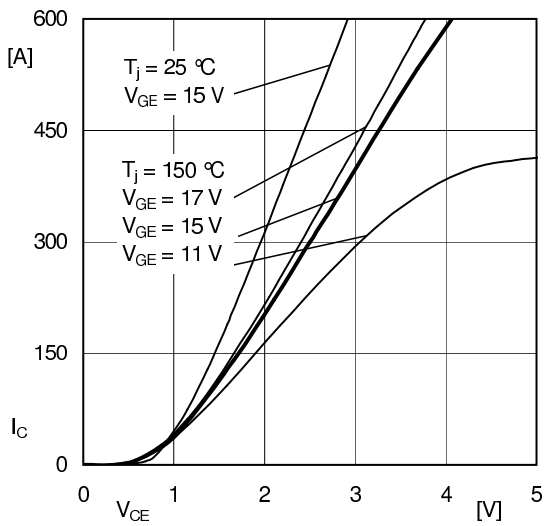

Fig. 1: Typ. output characteristic, inclusive  $R_{CC'+EE'}$

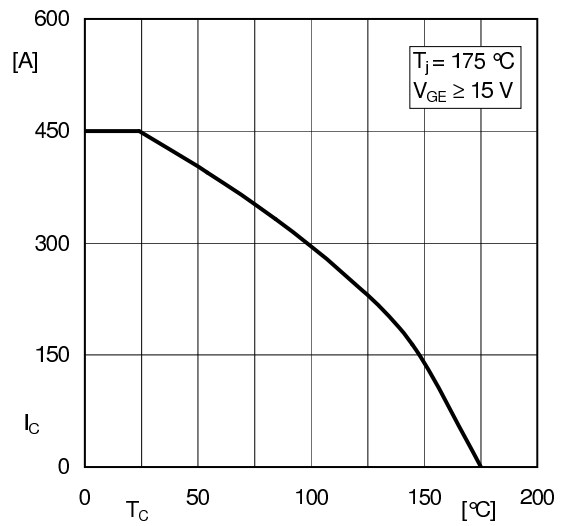

Fig. 2: Rated current vs. temperature  $I_C = f(T_C)$

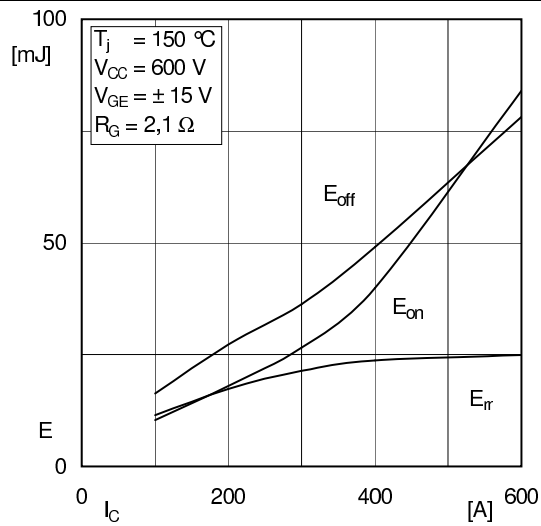

Fig. 3: Typ. turn-on /-off energy =  $f(I_C)$

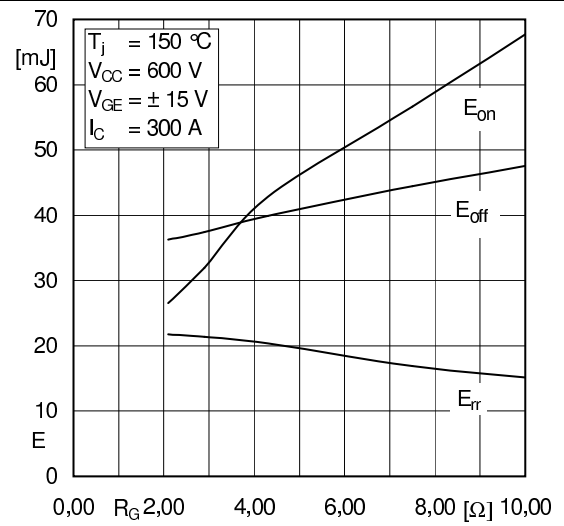

Fig. 4: Typ. turn-on /-off energy =  $f(R_G)$

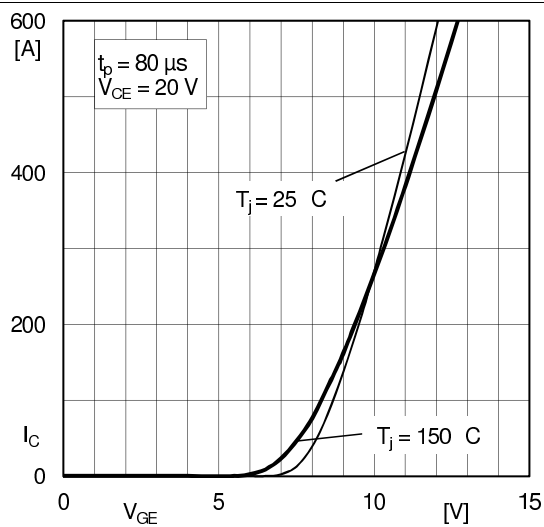

Fig. 5: Typ. transfer characteristic

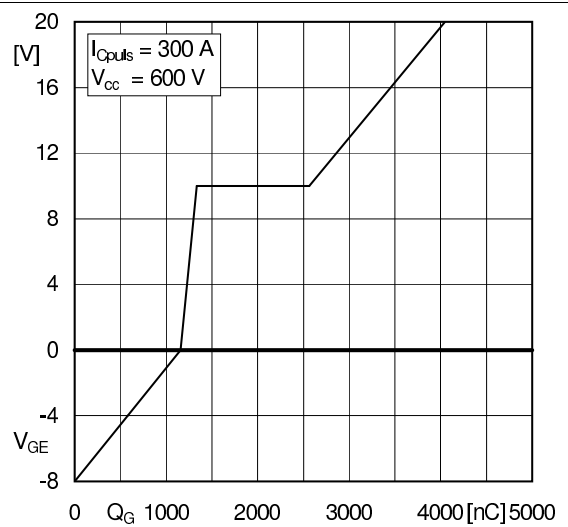

Fig. 6: Typ. gate charge characteristic

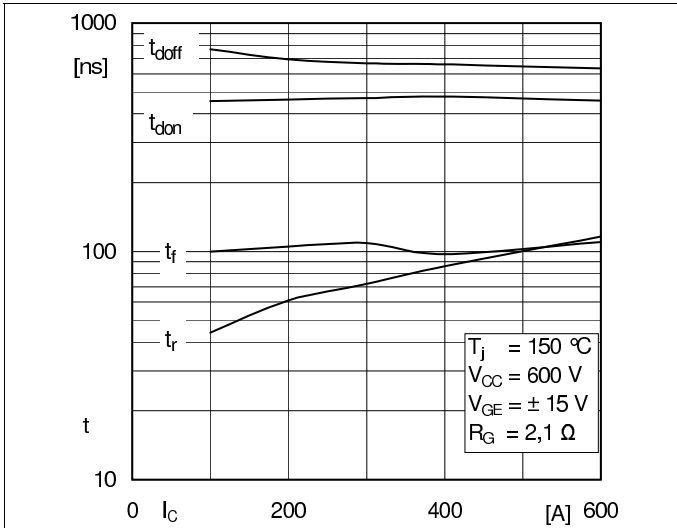

Fig. 7: Typ. switching times vs.  $I_C$

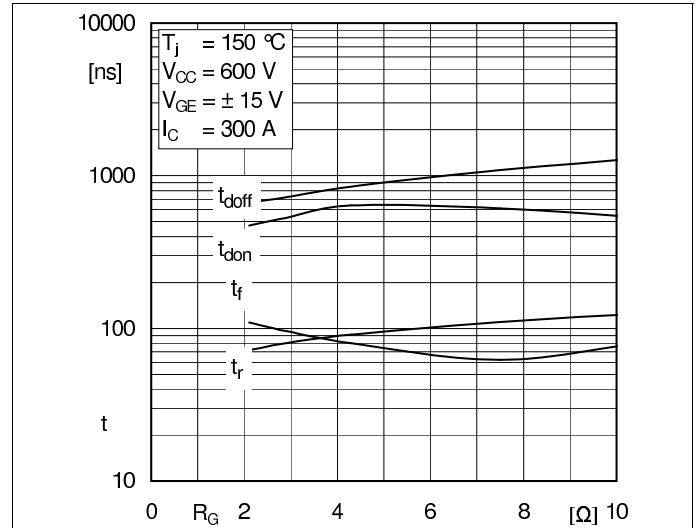

Fig. 8: Typ. switching times vs. gate resistor  $R_G$

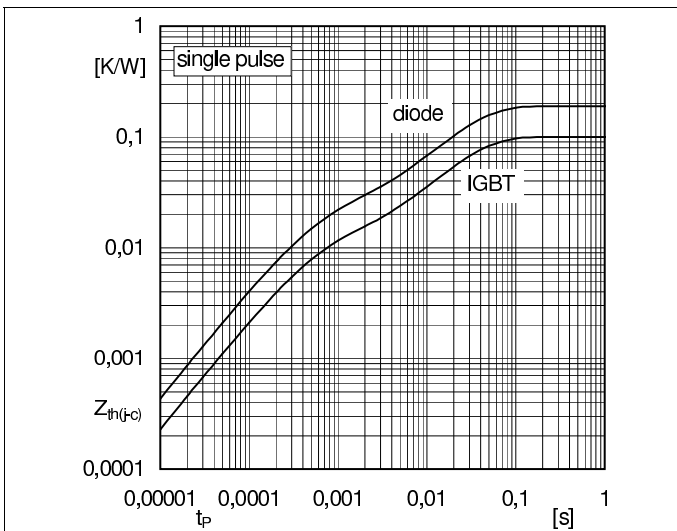

Fig. 9: Typ. transient thermal impedance

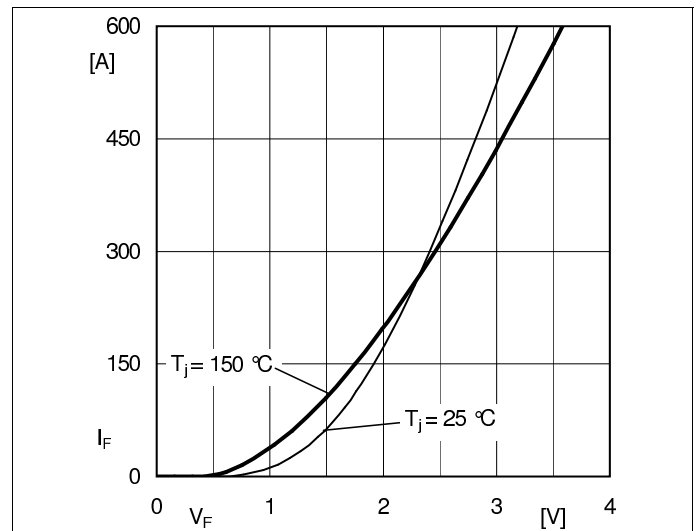

Fig. 10: Typ. CAL diode forward charact., incl.  $R_{CC+EE}$

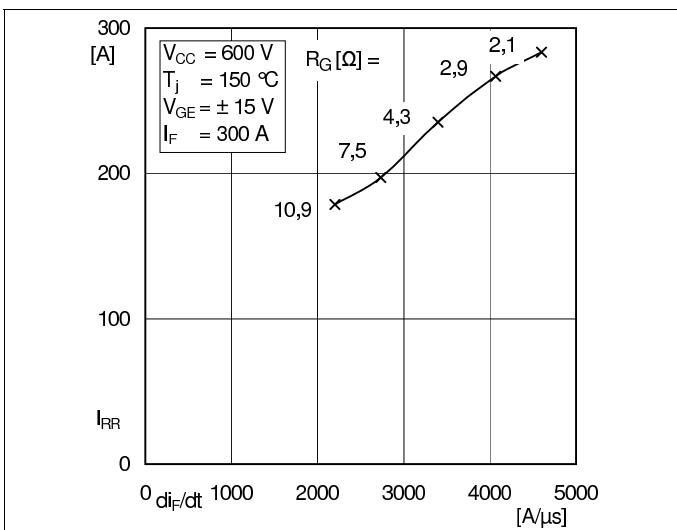

Fig. 11: Typ. CAL diode peak reverse recovery current

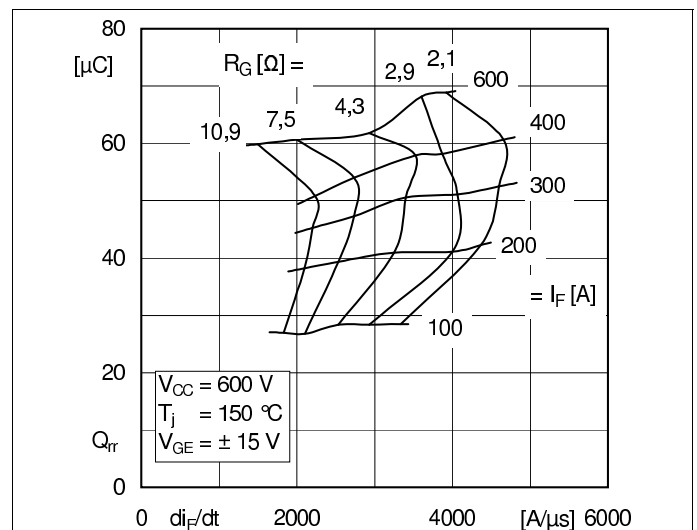
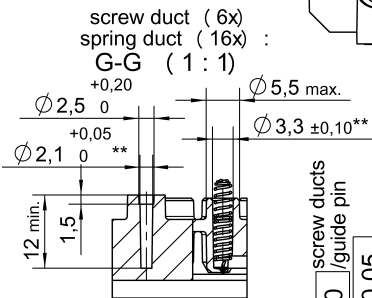
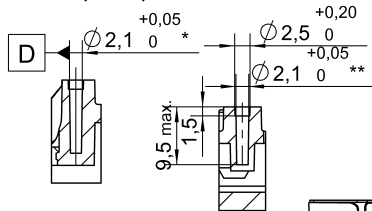

Fig. 12: Typ. CAL diode recovery charge

# SEMiX303GB12Vs

Case: SEMiX 3s

screw duct (left top) : F-F (1:1)  
 screw duct (1x centre) : H-H (1:1)



$\square$	0,3	connector 1-2 / 3-4
$\parallel$	0,2	each connector A

general tolerance:  
 ISO 2768-mK  
 ISO 8015

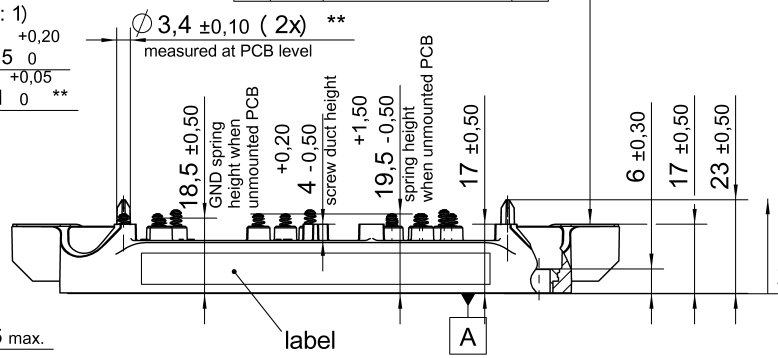

All measures in Z-direction valid when mounted to heat sink

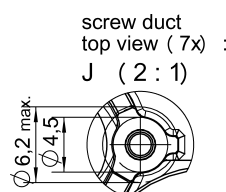
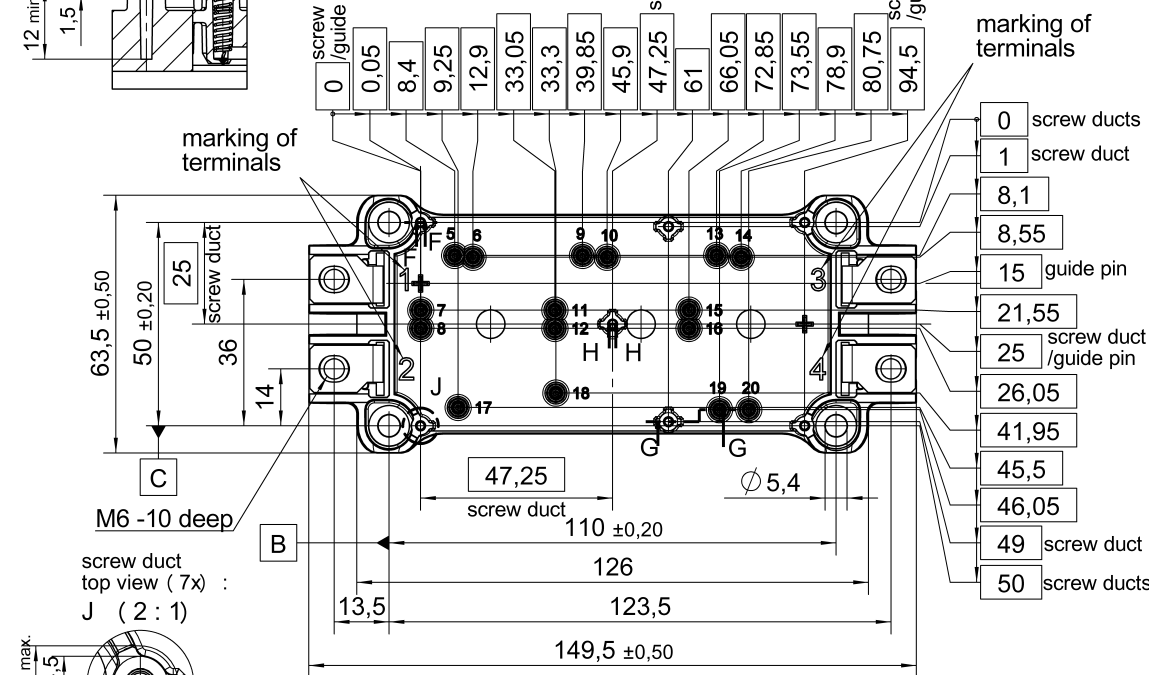

*screw duct left / top with	$\oplus$	$\phi$ 0,2	A	B	C	Rules for the contact PCB: - holes guidepins = $\phi$ 4 ± 0,1 / position tolerance ± 0,1 - holes for screws = $\phi$ 2,9 ± 0,1 / position tolerance ± 0,1 - spring contact pad = $\phi$ 3,6 ± 0,1 / position tolerance ± 0,1
**screw ducts / guide pins / spring ducts with	$\oplus$	$\phi$ 0,2	A	D	C	

SEMiX 3s

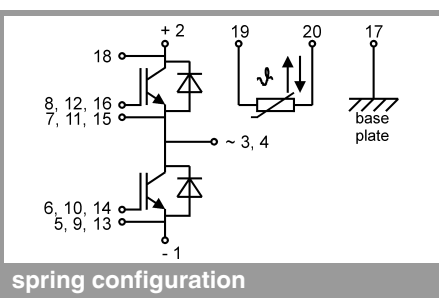

spring configuration

This is an electrostatic discharge sensitive device (ESDS), international standard IEC 60747-1, Chapter IX

\* The specifications of our components may not be considered as an assurance of component characteristics. Components have to be tested for the respective application. Adjustments may be necessary. The use of SEMIKRON products in life support appliances and systems is subject to prior specification and written approval by SEMIKRON. We therefore strongly recommend prior consultation of our staff.