

# SEMiX202GB12E4s



SEMiX<sup>®</sup> 2s

## Trench IGBT Modules

### SEMiX202GB12E4s

#### Features

- Homogeneous Si
- Trench = Trenchgate technology
- $V_{CE(sat)}$  with positive temperature coefficient
- High short circuit capability
- UL recognized, file no. E63532

#### Typical Applications\*

- AC inverter drives
- UPS
- Electronic Welding

#### Remarks

- Case temperature limited to  $T_C=125^{\circ}\text{C}$  max.
- Product reliability results are valid for  $T_j=150^{\circ}\text{C}$
- Dynamic values apply to the following combination of resistors:  
 $R_{Gon,main} = 1,0 \Omega$   
 $R_{Goff,main} = 1,0 \Omega$   
 $R_{G,X} = 2,2 \Omega$   
 $R_{E,X} = 0,5 \Omega$

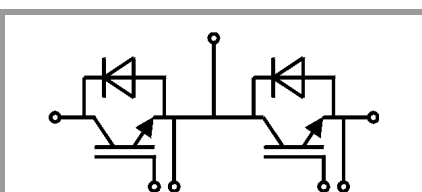

GB

Absolute Maximum Ratings				
Symbol	Conditions	Values	Unit	
<b>IGBT</b>				
$V_{CES}$		1200	V	
$I_C$	$T_j = 175^{\circ}\text{C}$	$T_c = 25^{\circ}\text{C}$	314	A
		$T_c = 80^{\circ}\text{C}$	242	A
$I_{Cnom}$		200	A	
$I_{CRM}$	$I_{CRM} = 3 \times I_{Cnom}$	600	A	
$V_{GES}$		-20 ... 20	V	
$t_{psc}$	$V_{CC} = 800\text{ V}$ $V_{GE} \leq 20\text{ V}$ $V_{CES} \leq 1200\text{ V}$	$T_j = 150^{\circ}\text{C}$	10	$\mu\text{s}$
$T_j$		-40 ... 175	$^{\circ}\text{C}$	
<b>Inverse diode</b>				
$I_F$	$T_j = 175^{\circ}\text{C}$	$T_c = 25^{\circ}\text{C}$	229	A
		$T_c = 80^{\circ}\text{C}$	172	A
$I_{Fnom}$		200	A	
$I_{FRM}$	$I_{FRM} = 3 \times I_{Fnom}$	600	A	
$I_{FSM}$	$t_p = 10\text{ ms, sin } 180^{\circ}, T_j = 25^{\circ}\text{C}$	990	A	
$T_j$		-40 ... 175	$^{\circ}\text{C}$	
<b>Module</b>				
$I_{t(RMS)}$		600	A	
$T_{stg}$		-40 ... 125	$^{\circ}\text{C}$	
$V_{isol}$	AC sinus 50Hz, t = 1 min	4000	V	

Characteristics					
Symbol	Conditions	min.	typ.	max.	Unit
<b>IGBT</b>					
$V_{CE(sat)}$	$I_C = 200\text{ A}$ $V_{GE} = 15\text{ V}$ chipelevel	$T_j = 25^{\circ}\text{C}$	1.8	2.05	V
		$T_j = 150^{\circ}\text{C}$	2.2	2.4	V
$V_{CE0}$		$T_j = 25^{\circ}\text{C}$	0.8	0.9	V
		$T_j = 150^{\circ}\text{C}$	0.7	0.8	V
$r_{CE}$	$V_{GE} = 15\text{ V}$	$T_j = 25^{\circ}\text{C}$	5.0	5.8	$\text{m}\Omega$
		$T_j = 150^{\circ}\text{C}$	7.5	8.0	$\text{m}\Omega$
$V_{GE(th)}$	$V_{GE}=V_{CE}, I_C = 7.6\text{ mA}$	5	5.8	6.5	V
$I_{CES}$	$V_{GE} = 0\text{ V}$ $V_{CE} = 1200\text{ V}$	$T_j = 25^{\circ}\text{C}$	0.1	0.3	$\text{mA}$
		$T_j = 150^{\circ}\text{C}$			$\text{mA}$
$C_{ies}$	$V_{CE} = 25\text{ V}$		12.3		nF
$C_{oes}$	$V_{GE} = 0\text{ V}$		0.81		nF
$C_{res}$			0.69		nF
$Q_G$	$V_{GE} = -8\text{ V...} + 15\text{ V}$		1130		nC
$R_{Gint}$	$T_j = 25^{\circ}\text{C}$		3.75		$\Omega$
$t_{d(on)}$	$V_{CC} = 600\text{ V}$ $I_C = 200\text{ A}$	$T_j = 150^{\circ}\text{C}$	253		ns
		$T_j = 150^{\circ}\text{C}$	55		ns
$E_{on}$	$R_{Gon} = 2.4\text{ }\Omega$	$T_j = 150^{\circ}\text{C}$	22		mJ
$t_{d(off)}$	$R_{Goff} = 2.4\text{ }\Omega$	$T_j = 150^{\circ}\text{C}$	533		ns
$t_f$	$di/dt_{on} = 3600\text{ A}/\mu\text{s}$ $di/dt_{off} = 2100\text{ A}/\mu\text{s}$	$T_j = 150^{\circ}\text{C}$	113		ns
		$T_j = 150^{\circ}\text{C}$	27.9		mJ
$R_{th(j-c)}$	per IGBT			0.14	K/W

# SEMiX202GB12E4s



SEMiX® 2s

## Trench IGBT Modules

### SEMiX202GB12E4s

#### Features

- Homogeneous Si
- Trench = Trenchgate technology
- $V_{CE(sat)}$  with positive temperature coefficient
- High short circuit capability
- UL recognized, file no. E63532

#### Typical Applications\*

- AC inverter drives
- UPS
- Electronic Welding

#### Remarks

- Case temperature limited to  $T_C=125^\circ\text{C}$  max.
- Product reliability results are valid for  $T_j=150^\circ\text{C}$
- Dynamic values apply to the following combination of resistors:  
 $R_{Gon,main} = 1,0 \Omega$   
 $R_{Goff,main} = 1,0 \Omega$   
 $R_{G,X} = 2,2 \Omega$   
 $R_{E,X} = 0,5 \Omega$

Characteristics						
Symbol	Conditions		min.	typ.	max.	Unit
<b>Inverse diode</b>						
$V_F = V_{EC}$	$I_F = 200 \text{ A}$ $V_{GE} = 0 \text{ V}$ chip	$T_j = 25^\circ\text{C}$		2.2	2.52	V
		$T_j = 150^\circ\text{C}$		2.1	2.5	V
$V_{F0}$		$T_j = 25^\circ\text{C}$	1.1	1.3	1.5	V
		$T_j = 150^\circ\text{C}$	0.7	0.9	1.1	V
$r_F$		$T_j = 25^\circ\text{C}$	4.0	4.5	5.1	m $\Omega$
		$T_j = 150^\circ\text{C}$	5.3	6.3	6.8	m $\Omega$
$I_{RRM}$	$I_F = 200 \text{ A}$	$T_j = 150^\circ\text{C}$		160		A
$Q_{rr}$	$di/dt_{off} = 3400 \text{ A}/\mu\text{s}$	$T_j = 150^\circ\text{C}$		31.5		$\mu\text{C}$
$E_{rr}$	$V_{GE} = -15 \text{ V}$ $V_{CC} = 600 \text{ V}$	$T_j = 150^\circ\text{C}$		12		mJ
$R_{th(j-c)}$	per diode				0.26	K/W
<b>Module</b>						
$L_{CE}$				18		nH
$R_{CC'+EE'}$	res., terminal-chip	$T_C = 25^\circ\text{C}$		0.7		m $\Omega$
		$T_C = 125^\circ\text{C}$		1		m $\Omega$
$R_{th(c-s)}$	per module			0.045		K/W
$M_s$	to heat sink (M5)		3		5	Nm
$M_t$		to terminals (M6)	2.5		5	Nm
						Nm
$w$					250	g
<b>Temperatur Sensor</b>						
$R_{100}$	$T_C=100^\circ\text{C}$ ( $R_{25}=5 \text{ k}\Omega$ )			$493 \pm 5\%$		$\Omega$
$B_{100/125}$	$R(T)=R_{100}\exp[B_{100/125}(1/T-1/T_{100})]$ ; $T[\text{K}]$ ;			$3550$ $\pm 2\%$		K

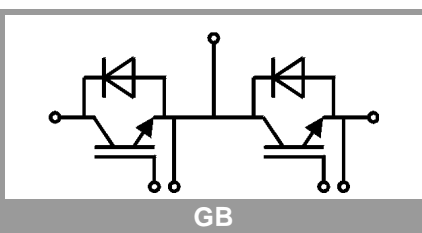

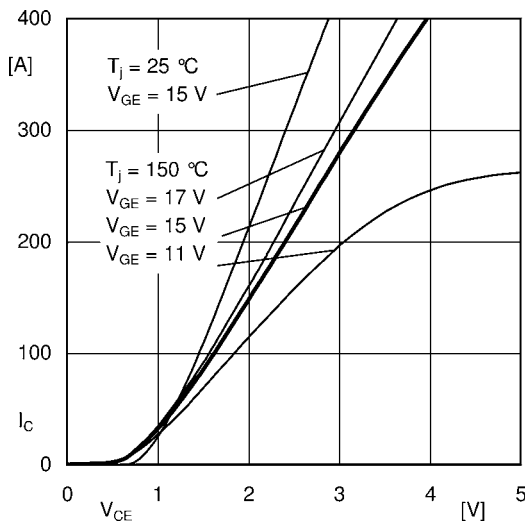

Fig. 1: Typ. output characteristic, inclusive  $R_{CC'+EE'}$

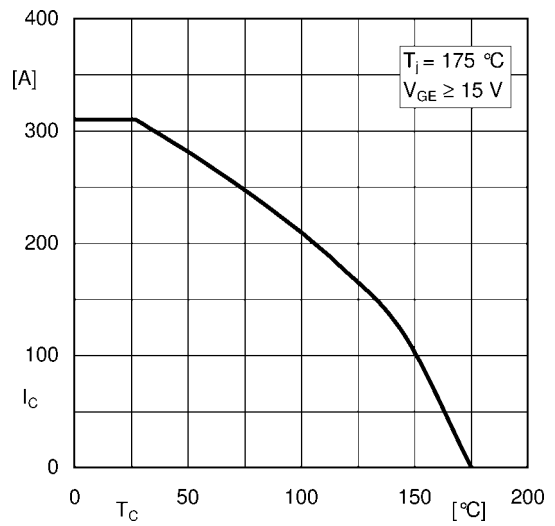

Fig. 2: Rated current vs. temperature  $I_C = f(T_C)$

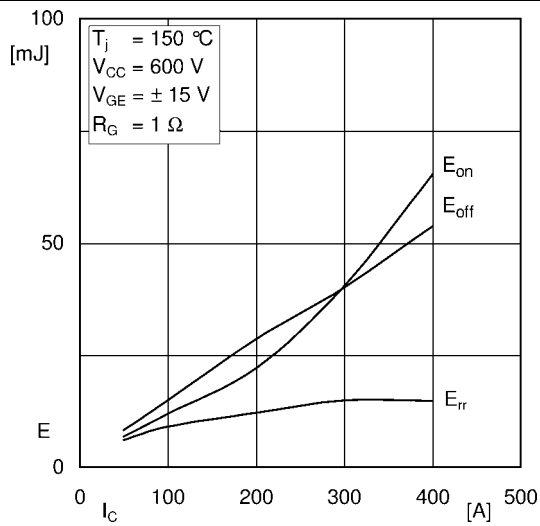

Fig. 3: Typ. turn-on /-off energy =  $f(I_C)$

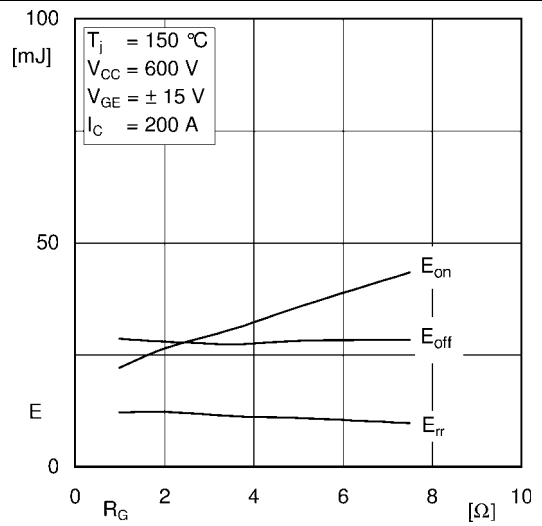

Fig. 4: Typ. turn-on /-off energy =  $f(R_G)$

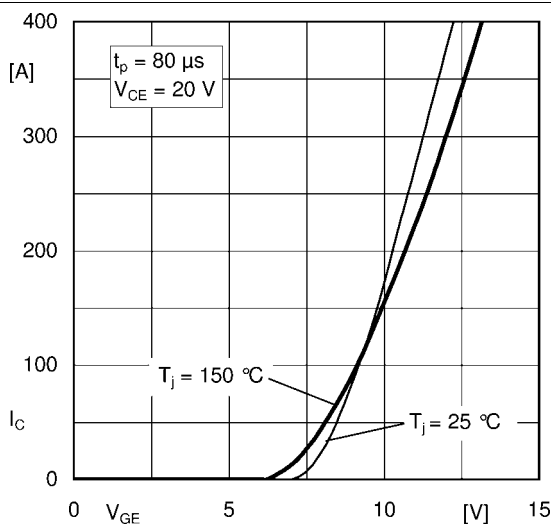

Fig. 5: Typ. transfer characteristic

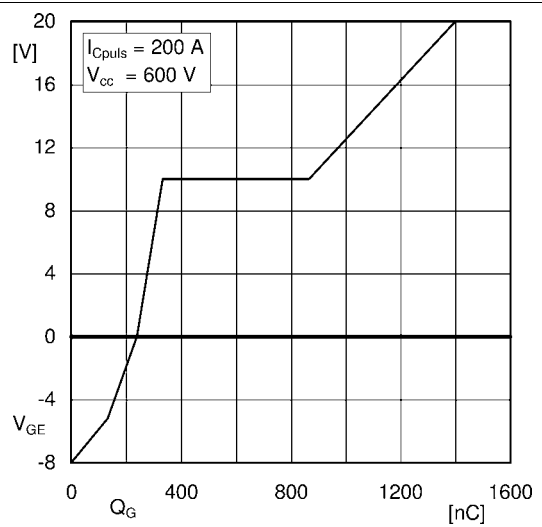

Fig. 6: Typ. gate charge characteristic

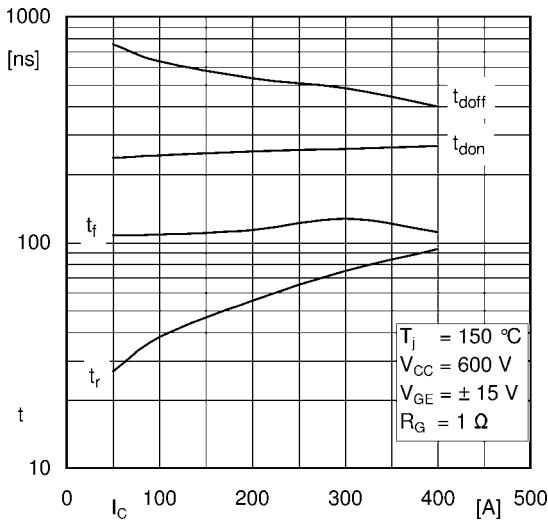

Fig. 7: Typ. switching times vs.  $I_C$

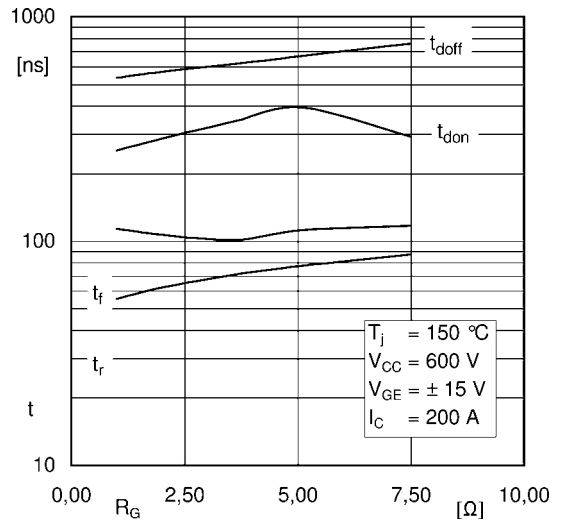

Fig. 8: Typ. switching times vs. gate resistor  $R_G$

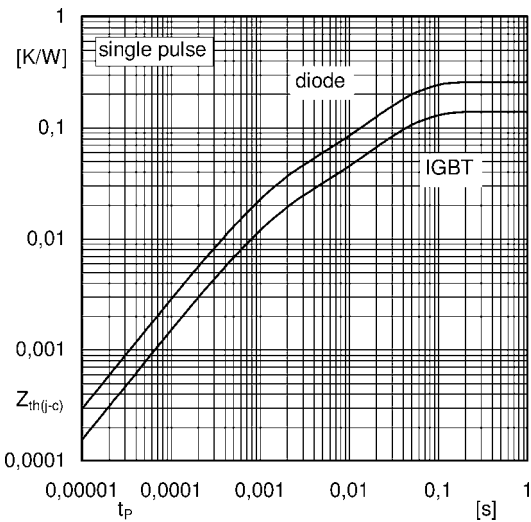

Fig. 9: Typ. transient thermal impedance

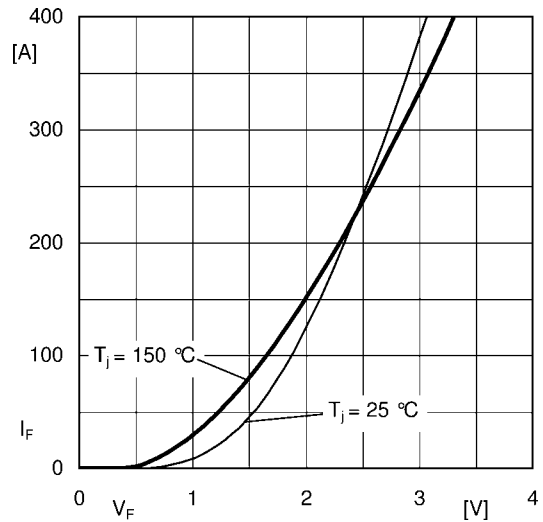

Fig. 10: Typ. CAL diode forward charact., incl.  $R_{CC+EE'}$

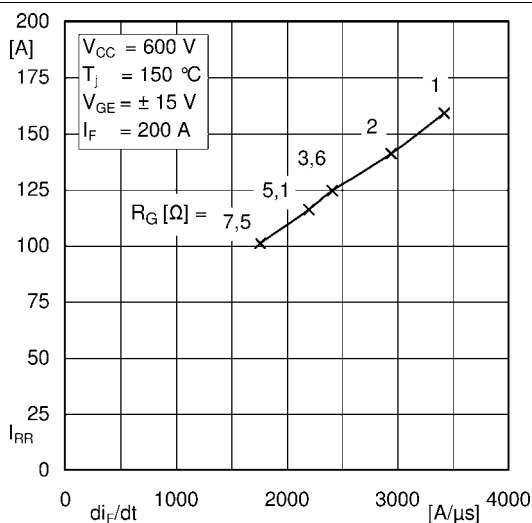

Fig. 11: Typ. CAL diode peak reverse recovery current

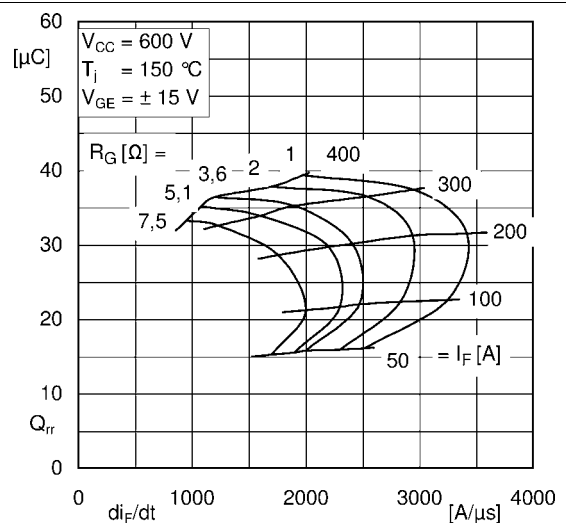

Fig. 12: Typ. CAL diode recovery charge

# SEMiX202GB12E4s

Case: SEMiX 2s

general tolerance:  
ISO 2768-mK  
ISO 8015

screw duct  
(left top) :  
F-F (1:1)

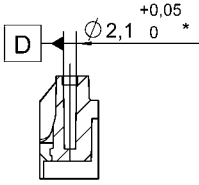

screw duct (4x)  
spring duct (12x) :  
G-G (1:1)

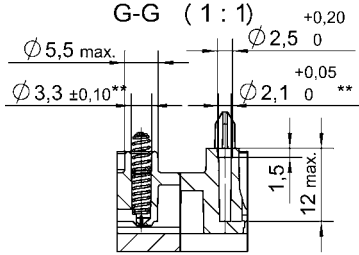

	0,3	connector 1-2 / 3-4
	0,2	each connector A

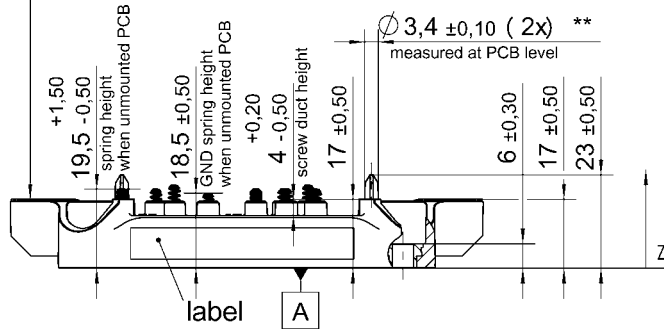

All measures in Z-direction  
valid when mounted to heat sink

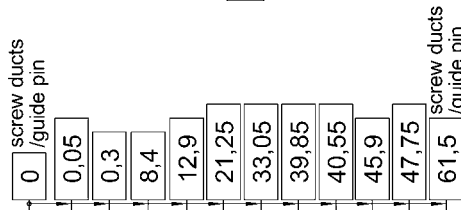

marking of terminals

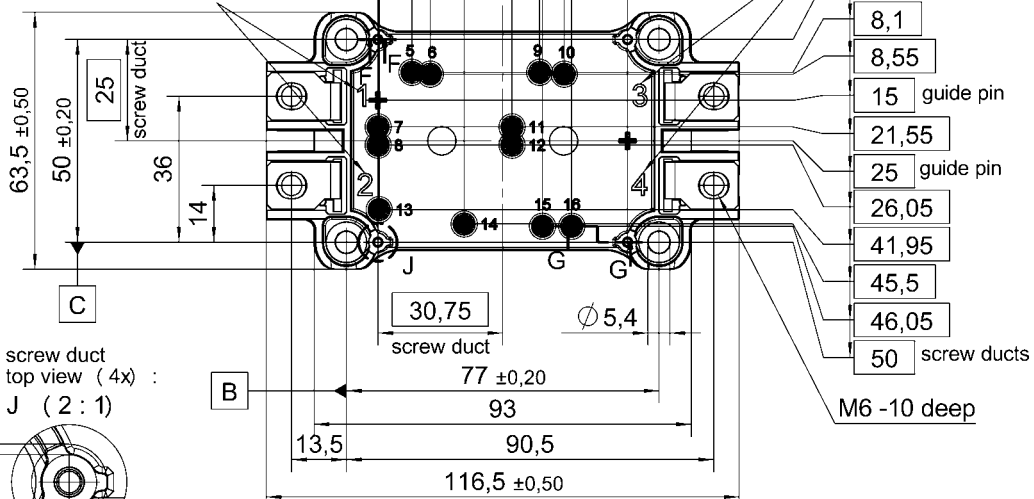

screw duct  
top view (4x) :  
J (2:1)

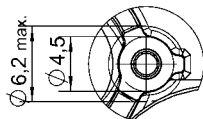

\*screw duct left / top with

	$\varnothing 0,2$	A	B	C
--	-------------------	---	---	---

\*\*screw ducts / guide pins / spring ducts with

	$\varnothing 0,2$	A	D	C
--	-------------------	---	---	---

Rules for the contact PCB:  
- holes guidepins =  $\varnothing 4 \pm 0,1$  / position tolerance  $\pm 0,1$   
- holes for screws =  $\varnothing 2,9 \pm 0,1$  / position tolerance  $\pm 0,1$   
- spring contact pad =  $\varnothing 3,6 \pm 0,1$  / position tolerance  $\pm 0,1$

SEMiX 2s

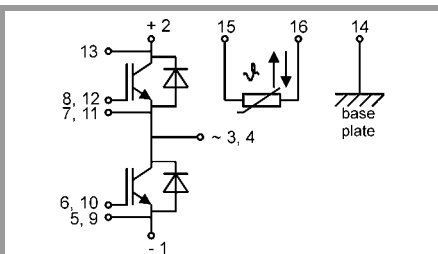

spring configuration

This is an electrostatic discharge sensitive device (ESDS), international standard IEC 60747-1, Chapter IX

\* The specifications of our components may not be considered as an assurance of component characteristics. Components have to be tested for the respective application. Adjustments may be necessary. The use of SEMIKRON products in life support appliances and systems is subject to prior specification and written approval by SEMIKRON. We therefore strongly recommend prior consultation of our personal.